

# **Massive Neutrinos, Neutrino Mixing, Oscillations, Leptonic CP Violation and Beyond**

**S. T. Petcov**

**SISSA/INFN, Trieste, Italy, and**

**IPMU, University of Tokyo, Japan**

**INRNE, Bulgarian Academy of Sciences, Sofia, Bulgaria**

**BCVSPIN Summer School**

**on Particle Physics and Cosmology**

**Hue, Vietnam, July 27, 2011**

## **Plan of Lectures**

- 1. Introduction.**
- 2. Massive Neutrinos, Neutrino Mixing and Oscillations.**
- 3. Three Neutrino Mixing: Current Status.**
- 4. Open Questions.**
- 5. Determining the Type of Neutrino Mass Spectrum.**
- 6. Dirac and Majorana CP Violation in the Lepton Sector.**
- 7. The Nature of Massive Neutrinos.**
- 6. Dirac and Majorana Leptonic CP-Violation and Leptogenesis.**
- 8. Conclusions.**

### 3 Families of Fundamental Particles

$$\begin{pmatrix} \nu_e & u \\ e & d \end{pmatrix} \quad \begin{pmatrix} \nu_\mu & c \\ \mu & s \end{pmatrix} \quad \begin{pmatrix} \nu_\tau & t \\ \tau & b \end{pmatrix} \quad + \text{ their antiparticles}$$

- 3 types (flavours) of active  $\nu$ 's and  $\tilde{\nu}$ 's
- The notion of "type" ("flavour") - dynamical;
- $\nu_e: \nu_e + n \rightarrow e^- + p; \quad \nu_\mu: \pi^+ \rightarrow \mu^+ + \nu_\mu$ ; etc.
- $\nu_l \neq \nu_{l'}, \tilde{\nu}_l \neq \tilde{\nu}_{l'}, l \neq l' = e, \mu, \tau; \nu_l \neq \tilde{\nu}_{l'}, l, l' = e, \mu, \tau.$

The states must be orthogonal (within the precision of the corresponding data):  $\langle \nu_l' | \nu_l \rangle = \delta_{ll'}, \langle \tilde{\nu}_l' | \tilde{\nu}_l \rangle = \delta_{ll'}, \langle \tilde{\nu}_l' | \nu_l \rangle = 0.$

- Data (relativistic  $\nu$ 's):  $\nu_l$  ( $\tilde{\nu}_l$ ) - predominantly LH (RH).

Standard Model:  $\nu_l, \tilde{\nu}_l - \nu_{lL}(x);$

$\nu_{lL}(x)$  form doublets with  $l_L(x)$ ,  $l = e, \mu, \tau$ :

$$\begin{pmatrix} \nu_{lL}(x) \\ l_L(x) \end{pmatrix} \quad l = e, \mu, \tau.$$

- No (compelling) evidence for existence of (relativistic)  $\nu$ 's ( $\tilde{\nu}$ 's) which are predominantly RH (LH):  $\nu_R$  ( $\tilde{\nu}_L$ .)

If  $\nu_{\tilde{R}}$ ,  $\tilde{\nu}_L$  exist, must have much weaker interaction than  $\nu_l$ ,  $\tilde{\nu}_l$ :  $\nu_R$ ,  $\tilde{\nu}_L$  - "sterile", "inert".

In the formalism of the SM,  $\nu_R$  and  $\tilde{\nu}_L$  - RH  $\nu$  fields B. Pontecorvo, 1967  
 $\nu_R(x)$ ; can be introduced in the SM as  $SU(2)_L$  singlets.

No experimental indications exist at present whether the SM should be minimally extended to include  $\nu_R(x)$ , and if it should, how many  $\nu_R(x)$  should be introduced.

$\nu_R(x)$  appear in many extensions of the SM, notably in  $SO(10)$  GUT's.



The RH  $\nu$ 's can play crucial role

- i) in the generation of  $m(\nu) \neq 0$ ,
- ii) in understanding why  $m(\nu) \ll m_l, m_q$ ,
- iii) in the generation of the observed matter-antimatter asymmetry of the Universe (via leptogenesis).

The simplest hypothesis is that to each  $\nu_{lL}(x)$  there corresponds a  $\nu_{lR}(x)$ ,  $l = e, \mu, \tau$ .

$\nu_{lR}(x)$  in the SM:  $Q_{el} = 0$ ,  $T_W = 0$ , thus  $Y_W = 0$ ;  $\nu_{lR}(x)$  - have no gauge couplings.

SM +  $m(\nu) \neq 0$ :  $L_l = const.$ ,  $l = e, \mu, \tau$ ;

$L \equiv L_e + L_\mu + L_\tau = const.$

## Compelling Evidences for $\nu$ -Oscillations

- $\nu_{\text{atm}}$ : SK UP-DOWN ASYMMETRY  
 $\theta_{z-}$ ,  $L/E$ - dependences of  $\mu$ -like events  
Dominant  $\nu_{\mu} \rightarrow \nu_{\tau}$  K2K, MINOS; CNGS (OPERA)
- $\nu_{\odot}$ : Homestake, Kamiokande, SAGE, GALLEX/GNO  
Super-Kamiokande, SNO, BOREXINO; KamLAND  
Dominant  $\nu_e \rightarrow \nu_{\mu, \tau}$  BOREXINO; KamLAND; ... LOWNU
- LSND: Dominant  $\bar{\nu}_{\mu} \rightarrow \bar{\nu}_e$ ;  
MINIBOONE 2010:  $\nu_{\mu} \rightarrow \nu_e$  incompatible,  $\bar{\nu}_{\mu} \rightarrow \bar{\nu}_e$  compatible (!?)

$$\nu_{lL}(x) = \sum_{j=1}^n U_{lj} \nu_{jL}(x), \quad \nu_{jL}(x) : m_j \neq 0; \quad l = e, \mu, \tau.$$

$$\nu_{lL} = \sum_{j=1}^n U_{lj} \nu_{jL} \quad l = e, \mu, \tau; \quad n \geq 3.$$

$n > 3$ : possible, e.g. if  $\nu_{lR}(x)$  present in the SM;  
 at least 3  $\nu_j$  “light”, choose:  $\nu_1, \nu_2, \nu_3, m_{1,2,3} \lesssim 1$  eV.

All compelling data compatible with 3- $\nu$  mixing:

$$\nu_{lL} = \sum_{j=1}^3 U_{lj} \nu_{jL} \quad l = e, \mu, \tau.$$

$\nu_j, m_j \neq 0$ : Dirac or Majorana particles.

$\nu$ -mixing: flavour neutrino oscillations possible.

$\nu_\mu, E$ ; at distance  $L$ :  $P(\nu_\mu \rightarrow \nu_\tau) \neq 0, P(\nu_\mu \rightarrow \nu_\mu) < 1$

$P(\nu_l \rightarrow \nu_{l'}) = P(\nu_l \rightarrow \nu_{l'}; E, L; U, m_j^2 - m_k^2)$

## Three Neutrino Mixing

$$\nu_{iL} = \sum_{j=1}^3 U_{ij} \nu_{jL} .$$

$U$  is the Pontecorvo-Maki-Nakagawa-Sakata (PMNS) neutrino mixing matrix,

$$U = \begin{pmatrix} U_{e1} & U_{e2} & U_{e3} \\ U_{\mu 1} & U_{\mu 2} & U_{\mu 3} \\ U_{\tau 1} & U_{\tau 2} & U_{\tau 3} \end{pmatrix}$$

- $U$  -  $n \times n$  unitary:

$$n \qquad 2 \qquad 3 \qquad 4$$

mixing angles:  $\frac{1}{2}n(n-1)$     1    3    6

CP-violating phases:

- $\nu_j$ – Dirac:  $\frac{1}{2}(n-1)(n-2)$     0    1    3

- $\nu_j$ – Majorana:  $\frac{1}{2}n(n-1)$     1    3    6

$n = 3$ : 1 Dirac and

2 additional CP-violating phases, Majorana phases

## Majorana Neutrinos

Can be defined in QFT using fields or states.

Fields:  $\chi_k(x)$  - 4 component (spin 1/2), complex,  $m_k$

Majorana condition:

$$C (\bar{\chi}_k(x))^T = \xi_k \chi_k(x), \quad |\xi_k|^2 = 1, \quad C^{-1} \gamma_\mu C = -\gamma_\mu^T; \quad C^T = -C, \quad C^{-1} = C^\dagger$$

- Invariant under proper Lorentz transformations.
- Reduces by 2 the number of components in  $\chi_k(x)$ .

Implications:

$$U(1) : \chi_k(x) \rightarrow e^{iQ\alpha} \chi_k(x) - \text{impossible}$$

- $\chi_k(x)$  cannot absorb phases.
- $Q_{U(1)} = 0 : Q_{el} = 0, L_l = 0, L = 0, \dots$
- $\chi_k(x)$ : 2 spin states of a spin 1/2 absolutely neutral particle
- $\chi_k \equiv \bar{\chi}_k$

Propagators:  $\Psi(x)$ –Dirac,  $\chi(x)$ –Majorana

$$\langle 0|T(\Psi_\alpha(x)\bar{\Psi}_\beta(y))|0\rangle = S_{\alpha\beta}^F(x-y),$$

$$\langle 0|T(\Psi_\alpha(x)\Psi_\beta(y))|0\rangle = 0, \quad \langle 0|T(\bar{\Psi}_\alpha(x)\bar{\Psi}_\beta(y))|0\rangle = 0.$$

$$\langle 0|T(\chi_\alpha(x)\bar{\chi}_\beta(y))|0\rangle = S_{\alpha\beta}^F(x-y),$$

$$\langle 0|T(\chi_\alpha(x)\chi_\beta(y))|0\rangle = -\xi^* S_{\alpha\kappa}^F(x-y)C_{\kappa\beta},$$

$$\langle 0|T(\bar{\chi}_\alpha(x)\bar{\chi}_\beta(y))|0\rangle = \xi C_{\alpha\kappa}^{-1} S_{\kappa\beta}^F(x-y)$$

$$U_{CP} \chi(x) U_{CP}^{-1} = \eta_{CP} \gamma_0 \chi(x'), \quad \eta_{CP} = \pm i.$$

# PMNS Matrix: Standard Parametrization

$$U = V \begin{pmatrix} 1 & 0 & 0 \\ 0 & e^{i\frac{\alpha_{21}}{2}} & 0 \\ 0 & 0 & e^{i\frac{\alpha_{31}}{2}} \end{pmatrix}$$

$$V = \begin{pmatrix} c_{12}c_{13} & s_{12}c_{13} & s_{13}e^{-i\delta} \\ -s_{12}c_{23} - c_{12}s_{23}s_{13}e^{i\delta} & c_{12}c_{23} - s_{12}s_{23}s_{13}e^{i\delta} & s_{23}c_{13} \\ s_{12}s_{23} - c_{12}c_{23}s_{13}e^{i\delta} & -c_{12}s_{23} - s_{12}c_{23}s_{13}e^{i\delta} & c_{23}c_{13} \end{pmatrix}$$

- $s_{ij} \equiv \sin \theta_{ij}$ ,  $c_{ij} \equiv \cos \theta_{ij}$ ,  $\theta_{ij} = [0, \frac{\pi}{2}]$ ,
- $\delta$  - Dirac CP-violation phase,  $\delta = [0, 2\pi]$ ,
- $\alpha_{21}$ ,  $\alpha_{31}$  - the two Majorana CP-violation phases.
- $\Delta m_{21}^2 \cong 7.6 \times 10^{-5} \text{ eV}^2 > 0$ ,  $\sin^2 \theta_{12} \cong 0.305$ ,  $\cos 2\theta_{12} \gtrsim 0.26$  ( $3\sigma$ ),
- $|\Delta m_{\text{atm}}^2| \cong |\Delta m_{31}^2| \cong 2.5 \times 10^{-3} \text{ eV}^2$ ,  $\sin^2 2\theta_{23} \cong 1$ ,
- $\theta_{13}$  - the CHOOZ angle:  $\sin^2 \theta_{13} < 0.040$  (0.056)  $2\sigma$  ( $3\sigma$ ).

A.Bandyopadhyay, S.Choubey, S.Goswami, S.T.P., D.P.Roy, arXiv:0804.4857;

T. Schwetz et al., arXiv:0808.2016

## Neutrino Oscillations in Vacuum

Suppose at  $t = 0$  in vacuum

$$|\nu_e\rangle = |\nu_1\rangle \cos\theta + |\nu_2\rangle \sin\theta,$$

$$|\nu_\mu(\tau)\rangle = -|\nu_1\rangle \sin\theta + |\nu_2\rangle \cos\theta; \quad \nu_{1,2}: \quad m_{1,2} \neq 0$$

After time  $t$  in vacuum

$$|\nu_e\rangle_t = e^{-iE_1 t} |\nu_1\rangle \cos\theta + e^{-iE_2 t} |\nu_2\rangle \sin\theta, \quad E_{1,2} = \sqrt{p^2 + m_{1,2}^2}$$

$$A(\nu_e \rightarrow \nu_\mu; t) = \langle \nu_\mu | \nu_e \rangle_t = \frac{1}{2} \sin 2\theta (e^{-iE_2 t} - e^{-iE_1 t})$$

$$P(\nu_e \rightarrow \nu_\mu; t) = \frac{1}{2} \sin^2 2\theta (1 - \cos(E_2 - E_1)t)$$

$$P(\nu_e \rightarrow \nu_e; t) \equiv P_{ee} = 1 - P(\nu_e \rightarrow \nu_\mu; t)$$

V. Gribov, B. Pontecorvo, 1969



**Neutrinos are relativistic:**  $t \cong L$ ,  $E_2 - E_1 \cong (m_2^2 - m_1^2)/(2p)$

$$(E_2 - E_1)t \cong (m_2^2 - m_1^2)L/(2p) = 2\pi \frac{L}{L_{osc}^{vac}}, \quad L_{osc}^{vac} \equiv \frac{4\pi E}{\Delta m^2}$$

$$P(\nu_e \rightarrow \nu_\mu; t) = \frac{1}{2} \sin^2 2\theta \left(1 - \cos 2\pi \frac{L}{L_{osc}^{vac}}\right), \quad L_{osc}^{vac} = \frac{4\pi E}{\Delta m^2}$$

$$L_{osc}^{vac} \cong 2.5 \text{ m} \frac{E[\text{MeV}]}{\Delta m^2[\text{eV}^2]}$$

$$E \cong 3 \text{ MeV}, \quad \Delta m^2[\text{eV}^2] \cong 8 \times 10^{-5} : L_{osc}^{vac} \cong 100 \text{ km}$$

$$E \cong 1 \text{ GeV}, \quad \Delta m^2[\text{eV}^2] \cong 2.5 \times 10^{-3} : L_{osc}^{vac} \cong 1000 \text{ km}$$

Effects of oscillations observable if

$$\sin^2 2\theta - \text{*sufficiently large*}, \quad L \gtrsim L_{osc}^{vac}$$

Two basic parameters:  $\sin^2 2\theta$ ,  $\Delta m^2$

SK, K2K, MINOS; CNGS (OPERA): dominant  $\nu_\mu \rightarrow \nu_\tau$

KamLAND:  $\bar{\nu}_e \rightarrow \bar{\nu}_e$ ;  $\bar{\nu}_e \rightarrow (\bar{\nu}_\mu + \bar{\nu}_\tau)/\sqrt{2}$

$\nu_e \rightarrow \nu_e$

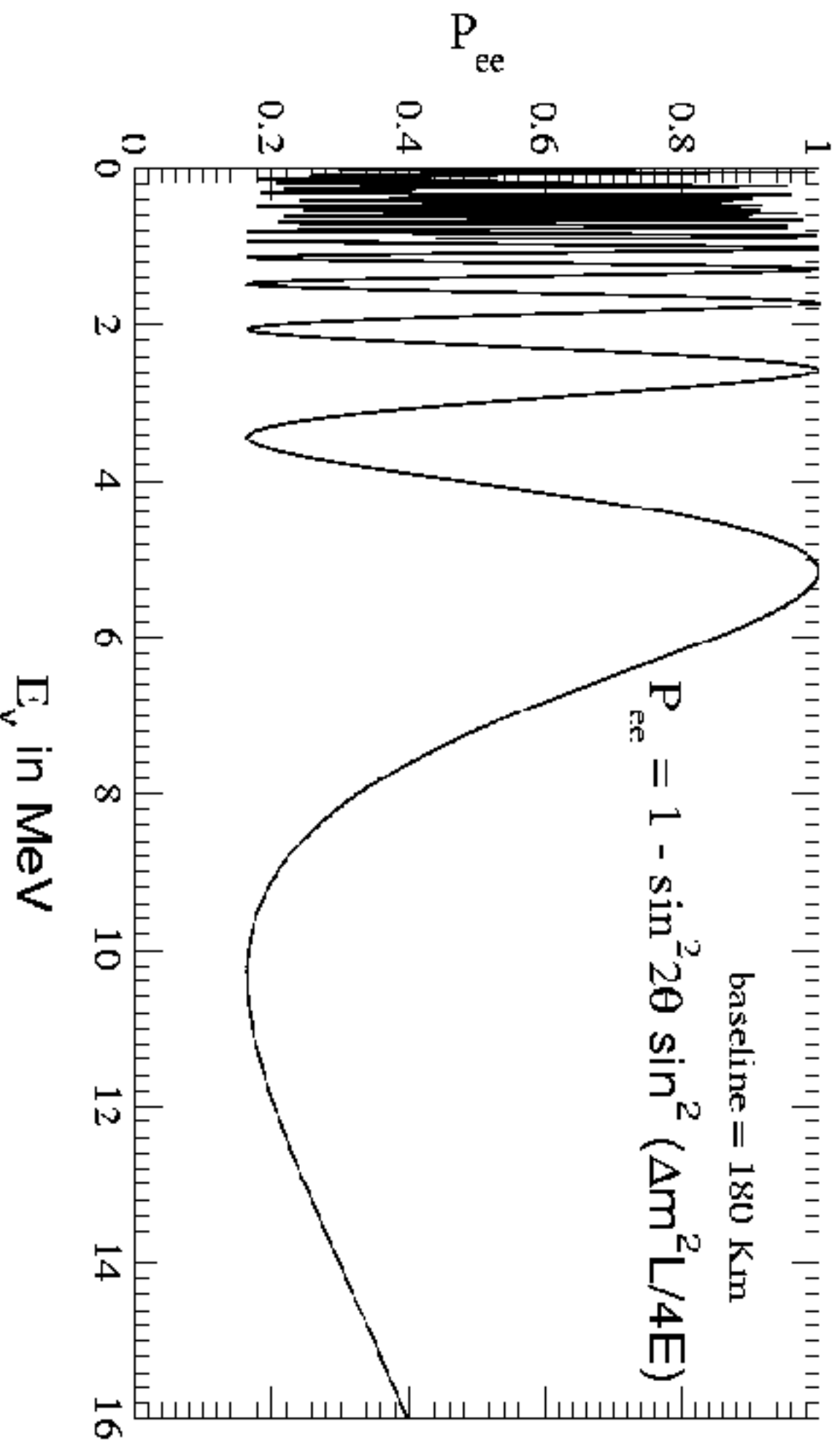

---

Source	Type of $\nu$	$\bar{E}$ [MeV]	$L$ [km]	$\min(\Delta m^2)$ [eV <sup>2</sup> ]
Reactor	$\bar{\nu}_e$	$\sim 1$	<b>1</b>	$\sim 10^{-3}$
Reactor	$\bar{\nu}_e$	$\sim 1$	<b>100</b>	$\sim 10^{-5}$
Accelerator	$\nu_\mu, \bar{\nu}_\mu$	$\sim 10^3$	<b>1</b>	$\sim 1$
Accelerator	$\nu_\mu, \bar{\nu}_\mu$	$\sim 10^3$	<b>1000</b>	$\sim 10^{-3}$
Atmospheric $\nu$ 's	$\nu_\mu, \bar{\nu}_\mu$	$\sim 10^3$	$10^4$	$\sim 10^{-4}$
Sun	$\nu_e$	$\sim 1$	$1.5 \times 10^8$	$\sim 10^{-11}$

---

Correspond to: CHOOZ ( $L \sim 1$  km), KamLAND ( $L \sim 100$  km),  $\bar{\nu}_e$  disappearance;  $E = (1.8 \div 8.0)$  MeV;

to accelerator experiments - past ( $L \sim 1$  km);

recent, current: K2K ( $L \sim 250$  km), MINOS ( $L \sim 730$  km),  $\nu_\mu$  disappearance; OPERA ( $L \sim 730$  km),  $\nu_\mu \rightarrow \nu_\tau$ ;

future: T2K ( $L \sim 250$  km), NO $\nu$ A ( $L \sim 800$  km),  $\nu_\mu$  disappearance,  $\nu_\mu \rightarrow \nu_e$ ;  $E \sim 1$  GeV;

SK experiment studying atmospheric  $\nu_\mu, \bar{\nu}_\mu, \nu_e, \bar{\nu}_e$  ( $E \cong (0.1 \div 100)$  GeV), and solar  $\nu_e$  ( $E \cong (0.29 \div 14)$  MeV) oscillations, and to the solar  $\nu$  experiments.

$$|\nu_l\rangle = \sum_j U_{lj}^* |\nu_j; \tilde{p}_j\rangle, \quad l = e, \mu, \tau$$

$\pi^+ \rightarrow \mu^+ + \nu_\mu$  decay at rest:

$$E_j = E + m_j^2 / (2m_\pi), \quad p_j = E - \xi m_j^2 / (2E), \quad E = (m_\pi / 2) (1 - m_\mu^2 / m_\pi^2) \cong 30 \text{ MeV}, \quad \xi = (1 + m_\mu^2 / m_\pi^2) / 2 \cong 0.8.$$

$$\text{Taking } m_j = 1 \text{ eV: } E_j \cong E (1 + 1.2 \times 10^{-16}), \\ p_j \cong E (1 - 4.4 \times 10^{-16}).$$

Problem avoided if one uses the fact that the  $\nu_j$  state is entangled with the  $\mu^+$  state.

$$A(\nu_l \rightarrow \nu_{l'}) = \sum_j U_{lj} D_j U_{j l'}^\dagger, \quad l, l' = e, \mu, \tau,$$

$$D_j = e^{-i\vec{p}_j(x_f - x_0)} = e^{-i(E_j T - p_j L)}, \quad p_j \equiv |\mathbf{p}_j|.$$

$$\begin{aligned} \delta\varphi_{jk} &= (E_j - E_K)T - (p_j - p_k)L \\ &= (E_j - E_K) \left[ T - \frac{E_j + E_K}{p_j + p_k} L \right] + \frac{m_j^2 - m_k^2}{p_j + p_k} L; \end{aligned}$$

First term - negligible:

- **$L$  and  $T$  related:  $T = (E_j + E_k) L / (p_j + p_k) = L / \bar{v}$ ,**

$$\bar{v} = (E_j / (E_j + E_k)) v_j + (E_k / (E_j + E_k)) v_k - \text{the "average" velocity of } \nu_j \text{ and } \nu_k,$$

$$v_{jk} = p_{j,k} / E_{j,k};$$

- $E_j = E_k = E_0$ ;

- $p_j = p_k = p$

(additionally suppressed by  $(m_j^2 + m_k^2) / p^2$ :  $L = T$  up to  $\sim m_{j,k}^2 / p^2$ );

- **$E_j \neq E_k$ ,  $p_j \neq p_k$ ,  $j \neq k$ : the same conclusion**  
(neutrinos are relativistic,  $L \cong T$  up to corrections  $\sim m_{j,k}^2 / E_{j,k}^2$ ).

$$\delta\varphi_{jk} \cong \frac{m_j^2 - m_k^2}{2p} L = 2\pi \frac{L}{L_{jk}^{\nu}} \text{sgn}(m_j^2 - m_k^2), \quad p = (p_j + p_k)/2,$$

$$L_{jk}^{\nu} = 4\pi \frac{p}{|\Delta m_{jk}^2|} \cong 2.5 \text{ m} \frac{p[\text{MeV}]}{|\Delta m_{jk}^2|[\text{eV}^2]}$$

is the neutrino oscillation length associated with  $\Delta m_{jk}^2$ .

- One can safely neglect the dependence of  $p_j$  and  $p_k$  on the masses  $m_j$  and  $m_k$  and consider  $p$  to be the zero neutrino mass momentum,  $p = E$ .
- The phase  $\delta\varphi_{jk}$  is Lorentz invariant.

$$\sigma_{m^2} = \sqrt{(2E\sigma_E)^2 + (2p\sigma_p)^2}$$

Condition for producing coherently  $\nu_1, \nu_2, \dots$ :

$$\sigma_{m^2} > \Delta m_{jk}^2$$

The equation used above corresponds to a plane wave description of the propagation of neutrinos  $\nu_j$ . It accounts only for the movement of the center of the wave packet describing  $\nu_j$ . In the wave packet treatment of the problem, the interference between the states of  $\nu_j$  and  $\nu_k$  is subject to a number of conditions, the localisation condition (in space and time) and the condition of overlapping of the wave packets of  $\nu_j$  and  $\nu_k$  at the detection point being the most important. For relativistic neutrinos, the localisation condition in space reads:  $\sigma_{xP}, \sigma_{xD} < L_{jk}^{\nu} / (2\pi)$ ,  $\sigma_{xP(D)}$  being the spatial width of the production (detection) wave packet. Thus, the interference will not be suppressed if the spatial width of the neutrino wave packets determined by the neutrino production and detection processes is smaller than the corresponding oscillation length in vacuum. In order for the interference to be nonzero, the wave packets describing  $\nu_j$  and  $\nu_k$  should also overlap in the point of neutrino detection. This requires that the spatial separation between the two wave packets at the point of neutrinos detection, caused by the two wave packets having different group velocities  $v_j \neq v_k$ , satisfies  $|(v_j - v_k)T| \ll \max(\sigma_{xP}, \sigma_{xD})$ . If the interval of time  $T$  is not measured,  $T$  in the preceding condition must be replaced by the distance  $L$  between the neutrino source and the detector.

## Examples

- Spatial localisation condition

$\Delta L$  - dimensions of the  $\nu$ - source (and/or detector):

$$2\pi\Delta L/L_{jk}^{\nu} \lesssim 1.$$

- Time localisation condition

$\Delta E$  - detector's energy resolution:

$$2\pi(L/L_{jk}^{\nu})(\Delta E/E) \lesssim 1.$$

If  $2\pi\Delta L/L_{jk}^{\nu} \gg 1$ , and/or  $2\pi(L/L_{jk}^{\nu})(\Delta E/E) \gg 1$ ,

$$\bar{P}(\nu_l \rightarrow \nu_{l'}) = \bar{P}(\bar{\nu}_l \rightarrow \bar{\nu}_{l'}) \cong \sum_j |U_{lj}|^2 |U_{l'j}|^2$$



Atmospheric Neutrinos  $\nu_\mu, \bar{\nu}_\mu, \nu_e, \bar{\nu}_e, E \sim 1 \text{ GeV}$  (0.20 - 100 GeV)

$$\nu_\mu + N \rightarrow \mu^- + X, \quad \bar{\nu}_\mu + N \rightarrow \mu^+ + X$$

$$\nu_e + N \rightarrow e^- + X, \quad \bar{\nu}_e + N \rightarrow e^+ + X$$

K2K, MINOS  $\nu_\mu (\bar{\nu}_\mu), E \sim 1 \text{ GeV}$

$$\nu_\mu + N \rightarrow \mu^- + X$$

Reactor  $\bar{\nu}_e, E \sim 2 \text{ MeV}$ : CHOOZ, KamLAND (2-8 MeV)

$$\bar{\nu}_e + p \rightarrow e^+ + n$$

# Atmospheric neutrinos

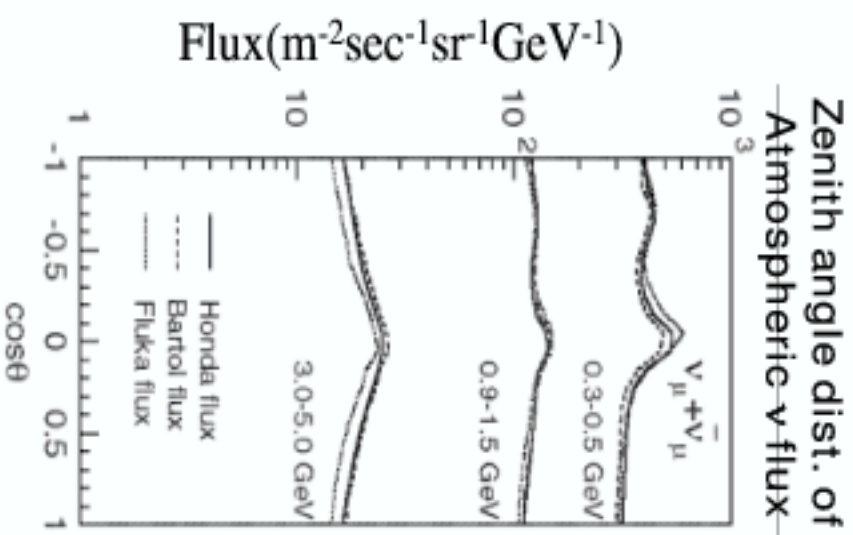
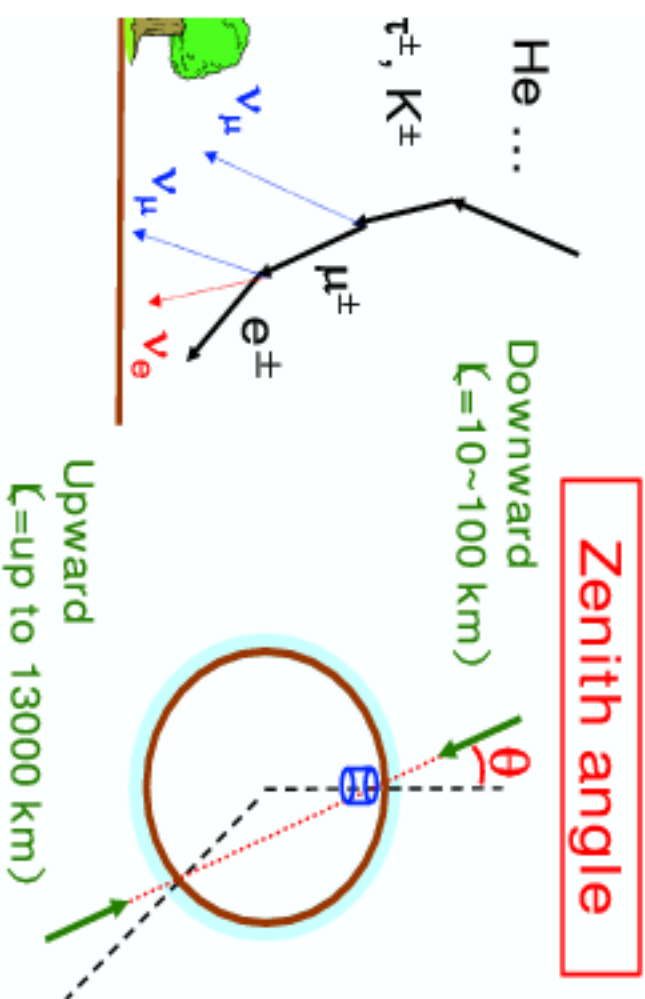

**Ev > a few GeV**  
**Up/Down Symmetry**

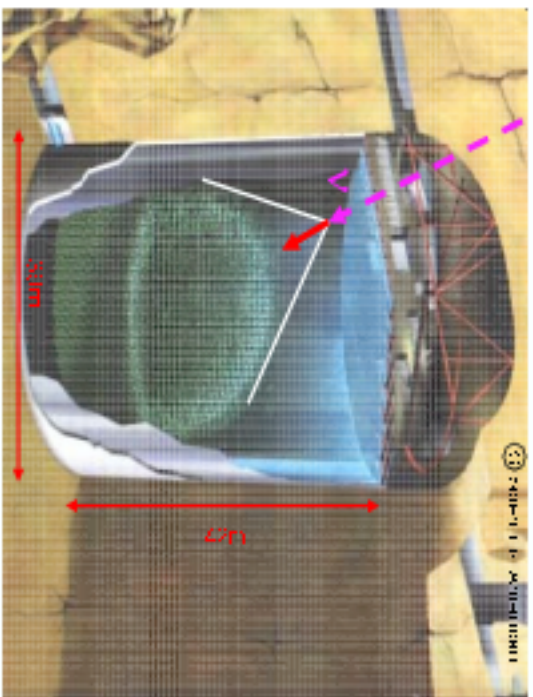

Water Cherenkov detector

1000 m underground  
 50,000 ton (22,500 ton fid.)  
 Inner-detector(ID): 11,146  
 Outer-detector(OD): 1,885

Event classification

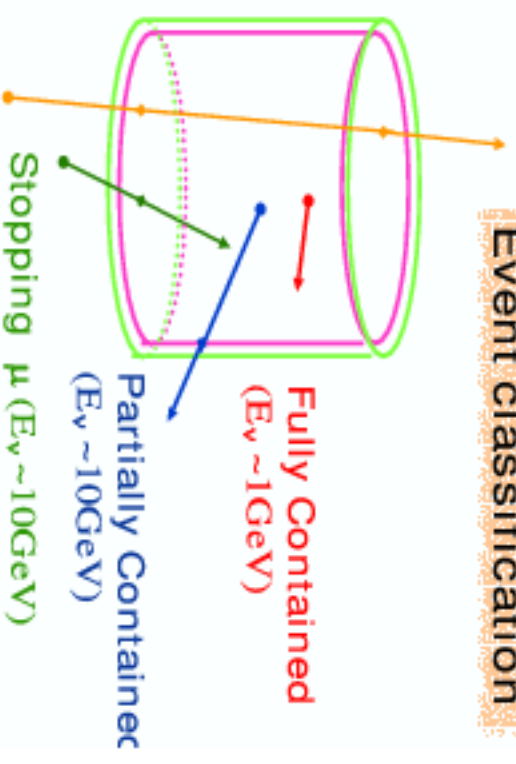

Through-going  $\mu$  ( $E_\nu \sim 1000\text{GeV}$ )  
 20 inch PMTs(SK-1)  
 8 inch PMTs



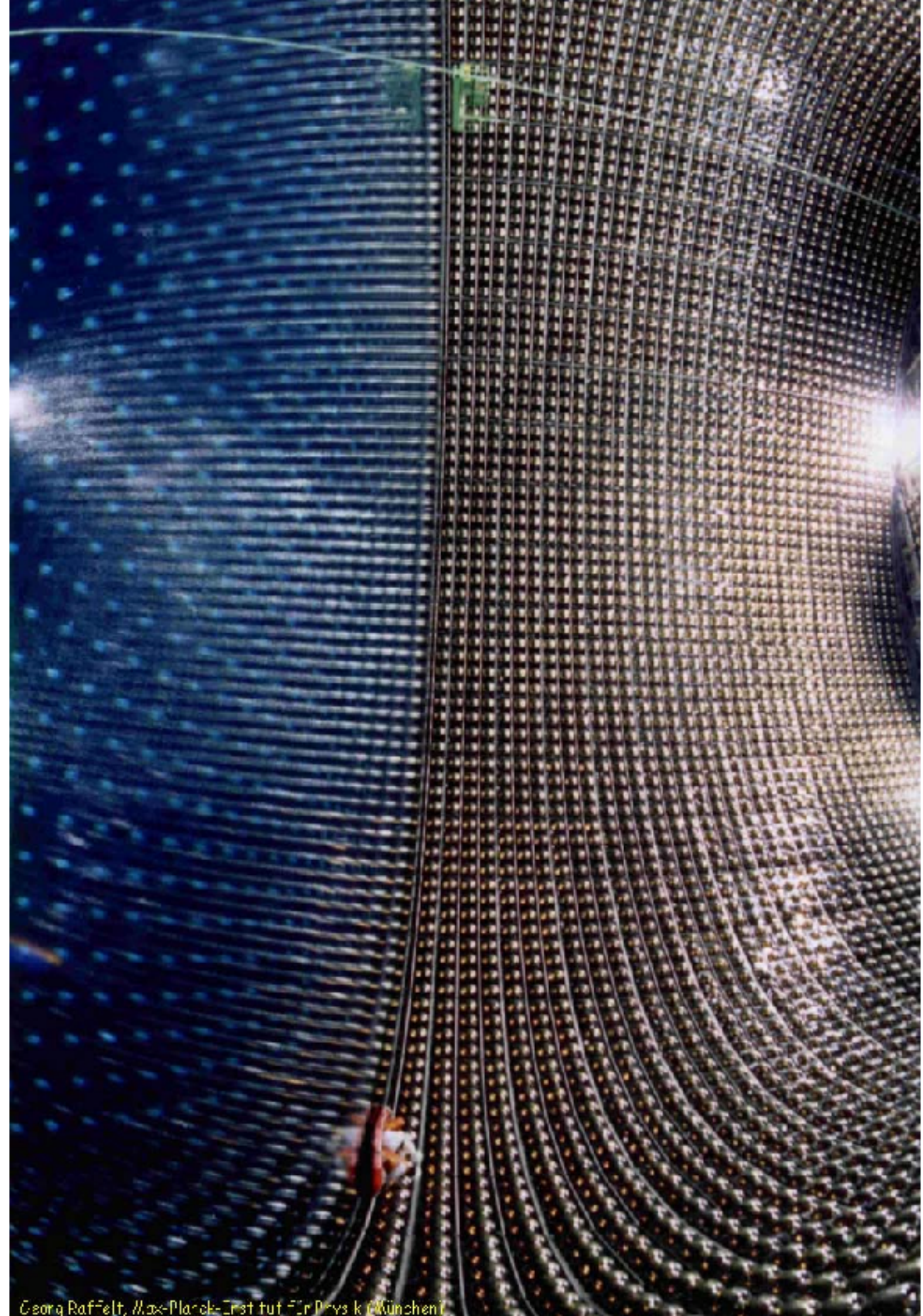



# Zenith angle distributions

$\nu_\mu \leftrightarrow \nu_\tau$   
2-flavor oscillations

Best fit  
Null oscillation

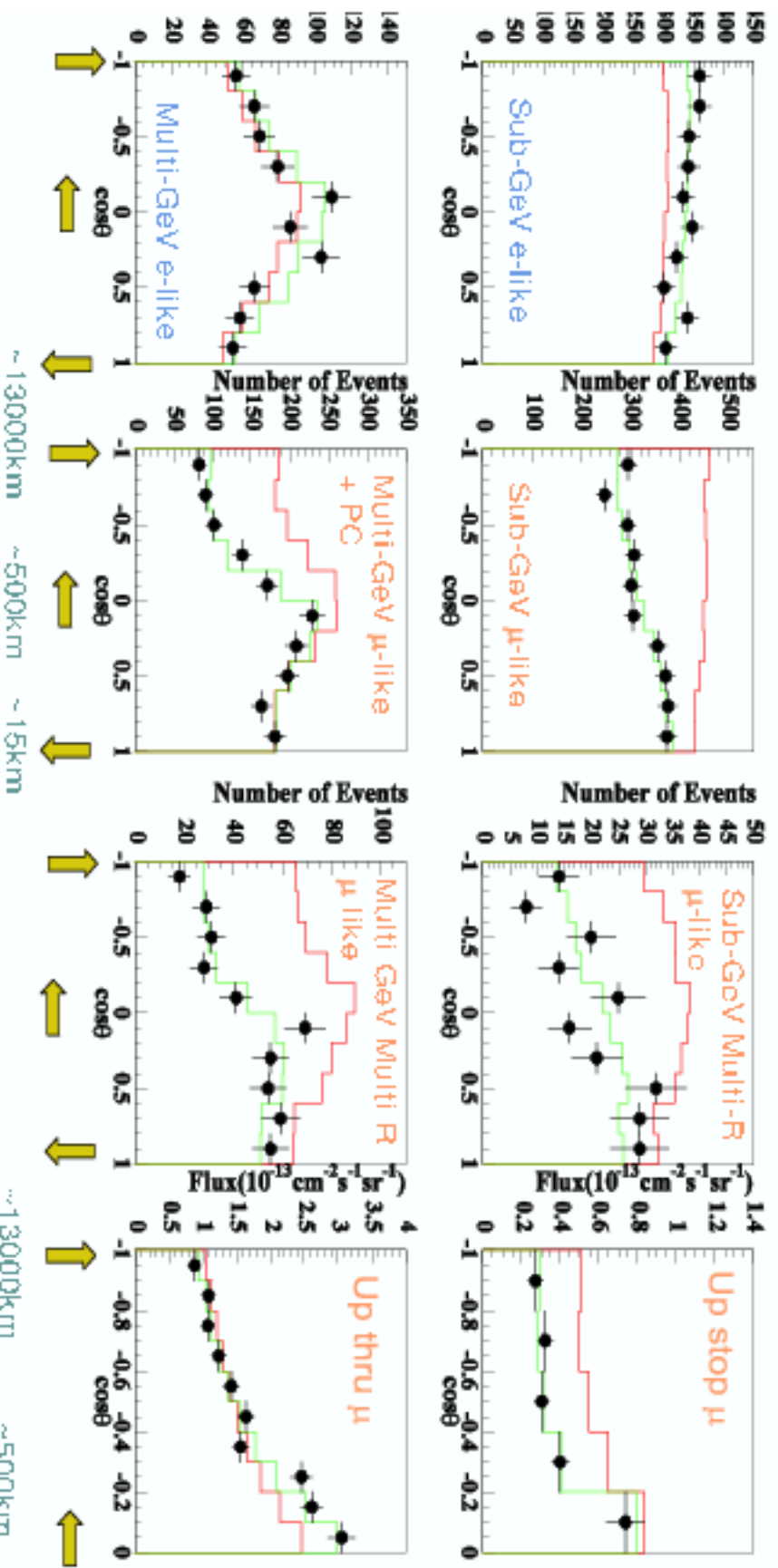

## SK: $L/E$ Dependence, $\mu$ -Like Events

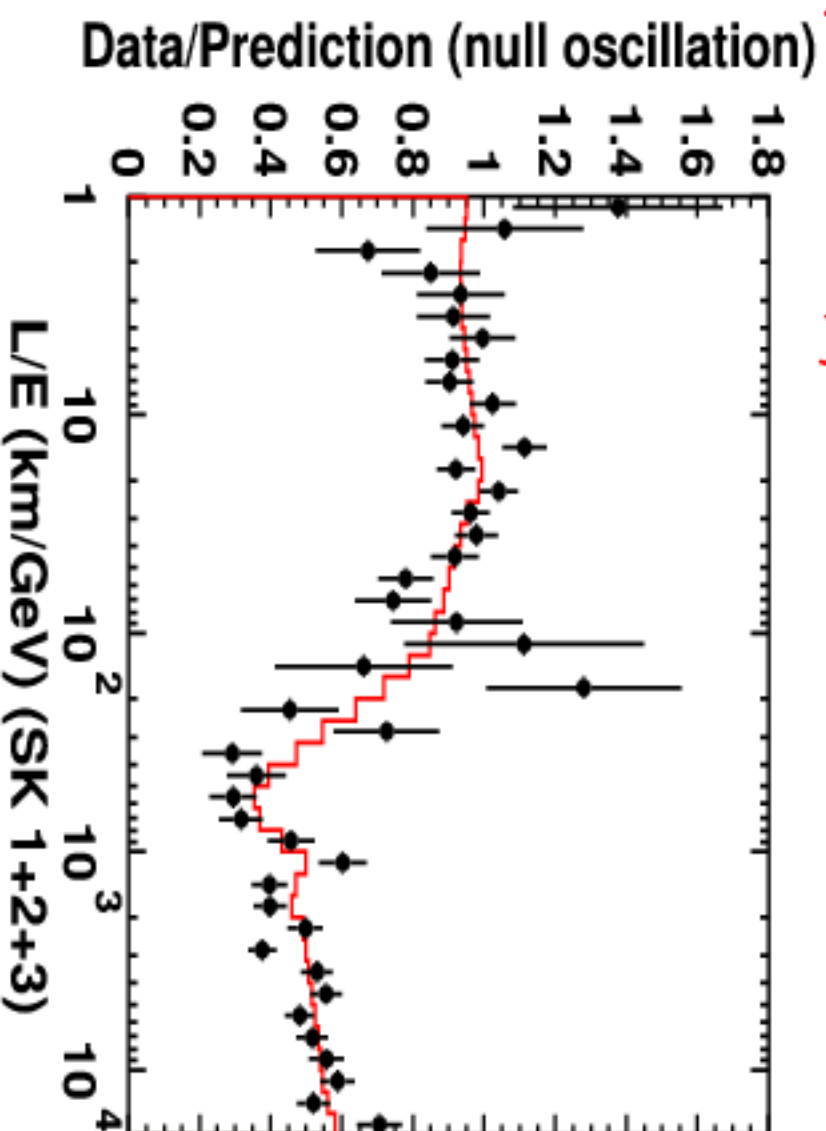

## L/E analysis

Neutrino oscillation :  $P_{\mu\mu} = 1 - \sin^2 2\theta \sin^2(1.27 \frac{\Delta m^2 L}{E})$

Neutrino decay :  $P_{\mu\mu} = (\cos^2 \theta + \sin^2 \theta \times \exp(-\frac{m}{2\tau} \frac{L}{E}))^2$

Neutrino decoherence :  $P_{\mu\mu} = 1 - \frac{1}{2} \sin^2 2\theta \times (1 - \exp(-\gamma_0 \frac{L}{E}))$

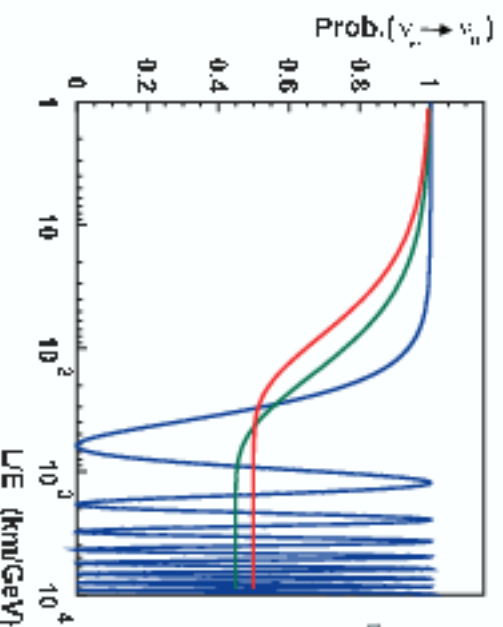

Use events with high resolution in L/E

→ The first dip can be observed

- Direct evidence for oscillations
- Strong constraint to oscillation parameters, especially  $\Delta m^2$  value

## SK: Atmospheric $\nu$ Data

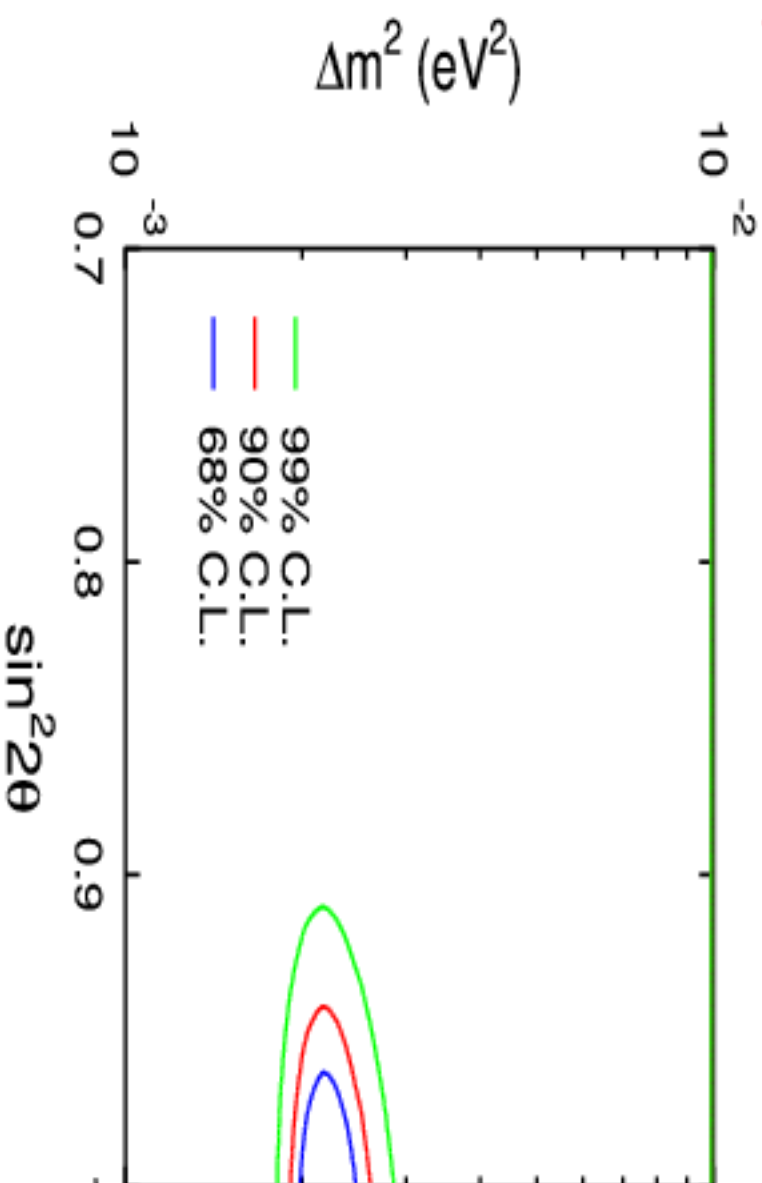

$\Delta m_{\text{atm}}^2 \equiv \Delta m_{31}^2 = 2.4 \times 10^{-3}$  eV<sup>2</sup>,  $\sin^2 \theta_{\text{atm}} \equiv \sin^2 2\theta_{23} = 1.0$  ;

$\Delta m_{31}^2 = (1.9 - 2.9) \times 10^{-3}$  eV<sup>2</sup>,  $\sin^2 2\theta_{23} \geq 0.92$ , 99% C.L.

- sign of  $\Delta m_{\text{atm}}^2$  not determined. If  $\theta_{23} \neq \frac{\pi}{4}$ :  $\theta_{23}$ , ( $\frac{\pi}{4} - \theta_{23}$ ) ambiguity.

3- $\nu$  mixing:  $\Delta m_{31}^2 > 0$ ,  $m_1 < m_2 < m_3$  (NH);  $\Delta m_{31}^2 < 0$ ,  $m_3 < m_1 < m_2$  (IH).



# K2K: $\nu_\mu$ Spectrum

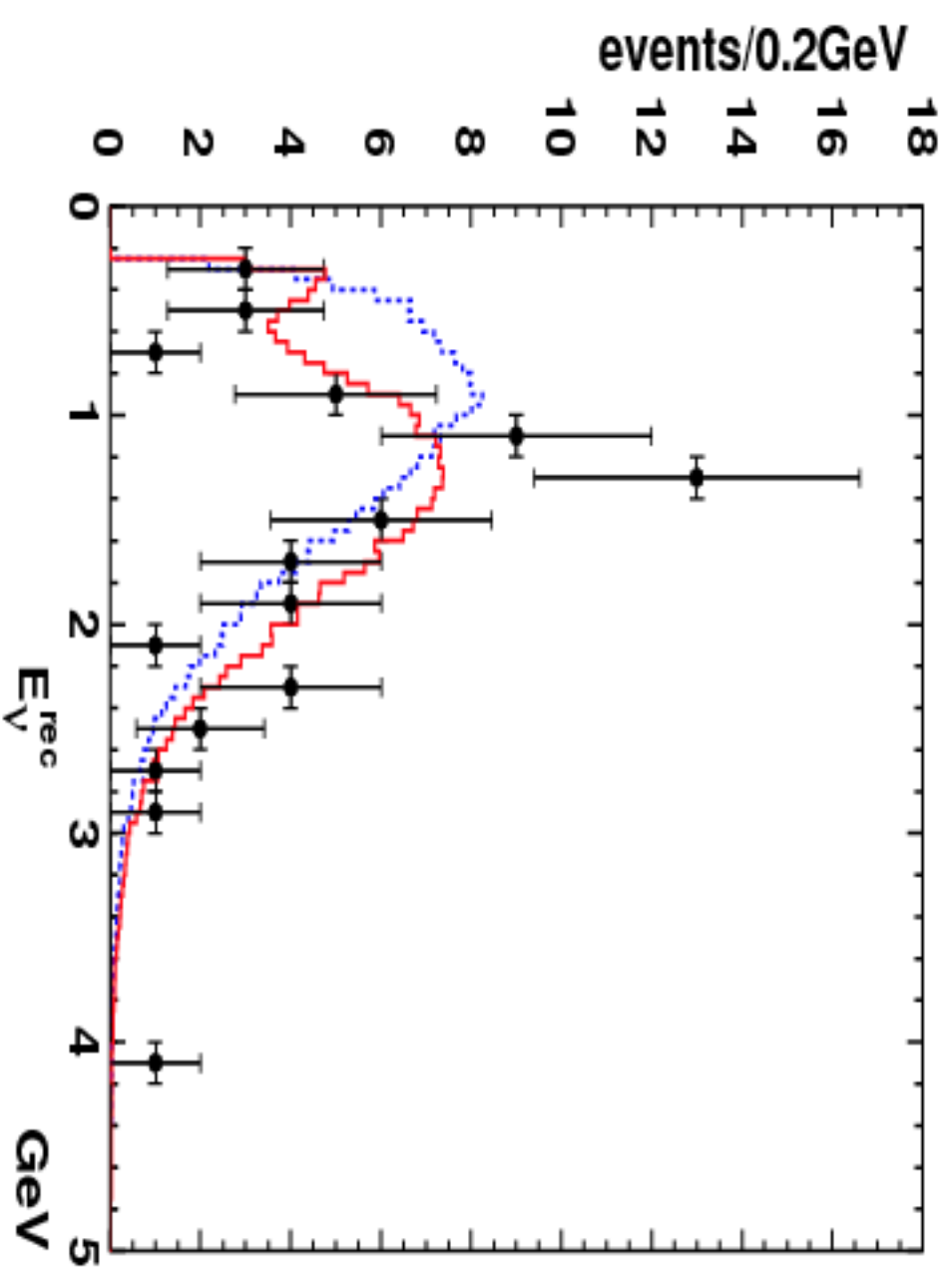

# MINOS: $\nu_\mu$ Spectrum

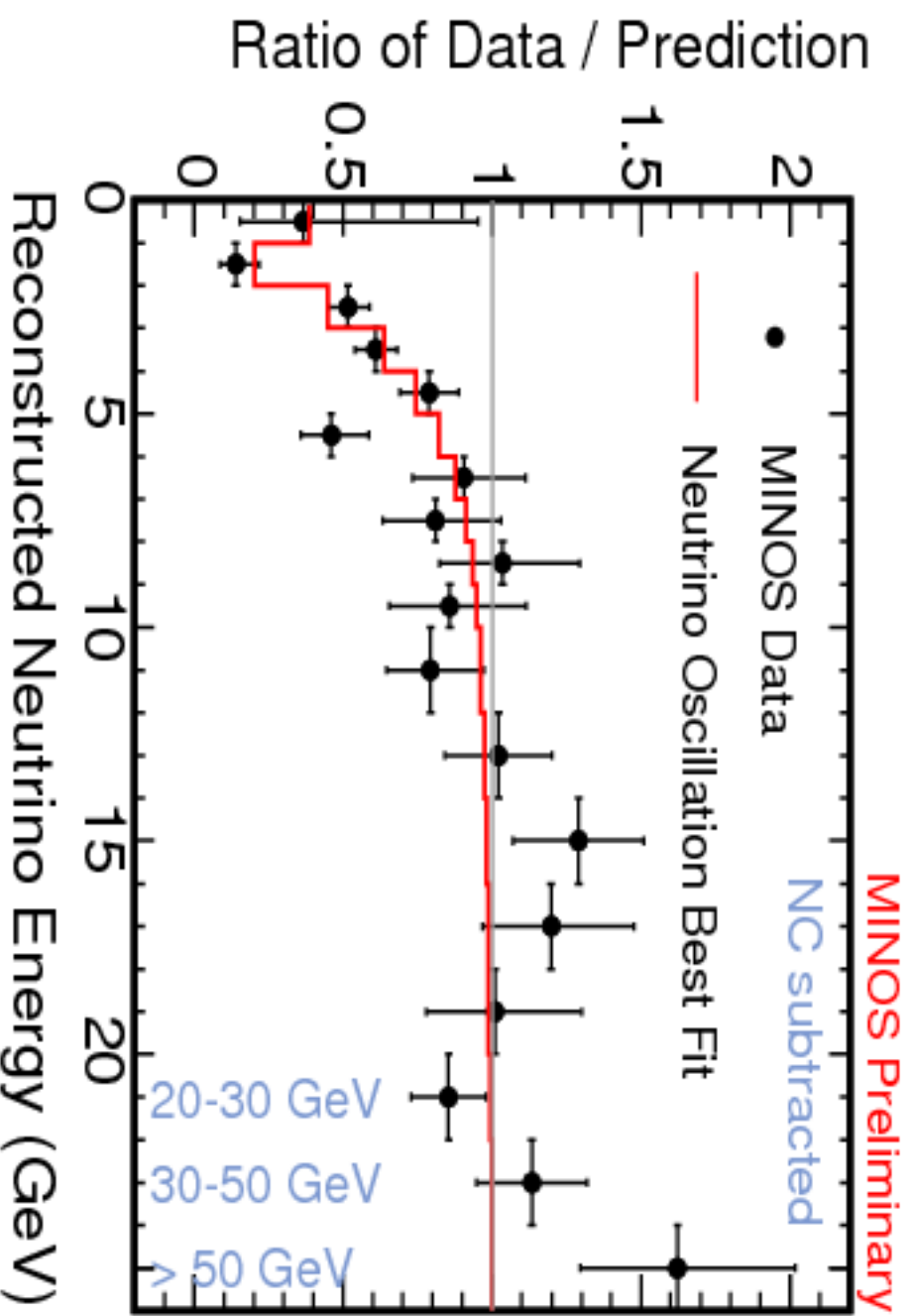

## "atmospheric" parameters

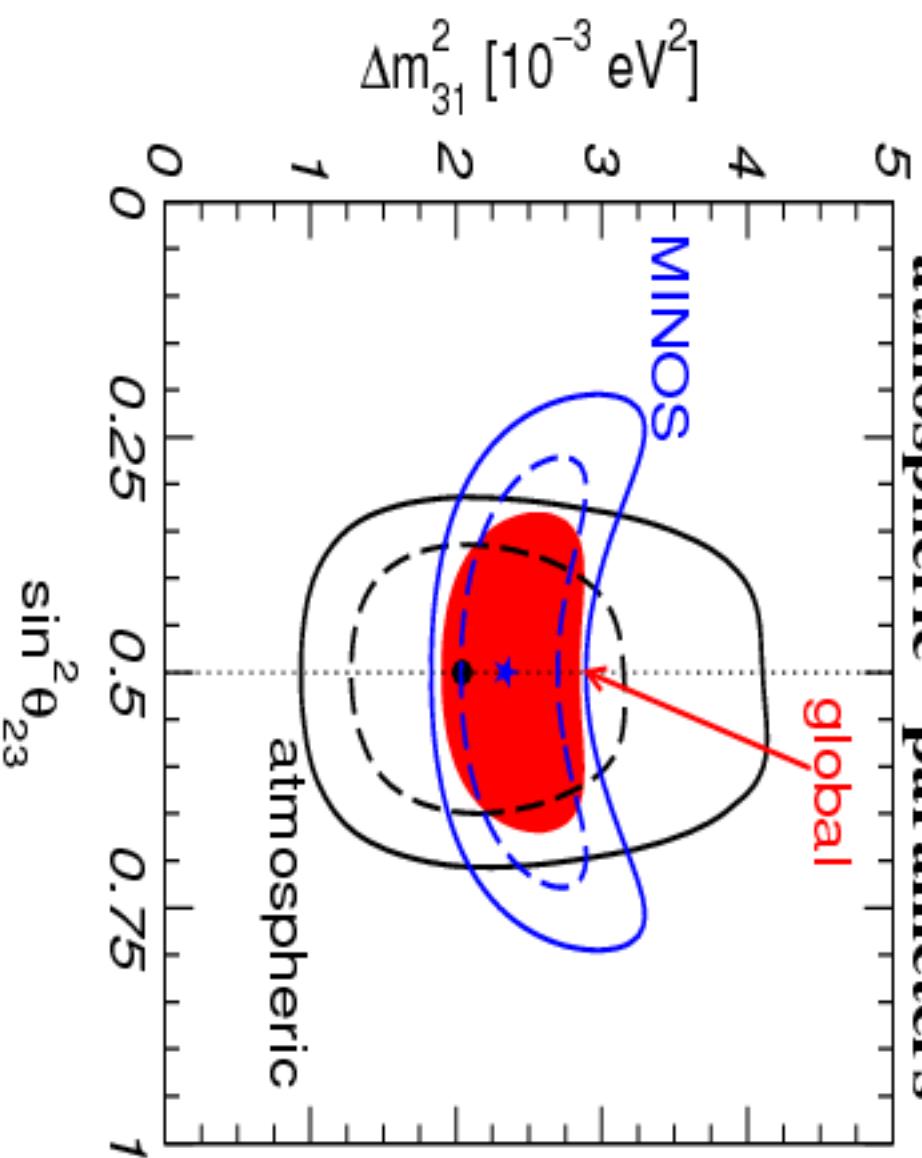

T. Schwetz, [arXiv:0710.5027](https://arxiv.org/abs/0710.5027) [hep-ph]

- sign of  $\Delta m_{\text{atm}}^2$  not determined;

3- $\nu$  mixing:  $\Delta m_{31}^2 > 0$ ,  $m_1 < m_2 < m_3$  (normal ordering (NO));

$\Delta m_{31}^2 < 0$ ,  $m_3 < m_1 < m_2$  (Inverted ordering (IO)).

- If  $\theta_{23} \neq \frac{\pi}{4}$ :  $\theta_{23}$ ,  $(\frac{\pi}{4} - \theta_{23})$  ambiguity.

# Survival Probability

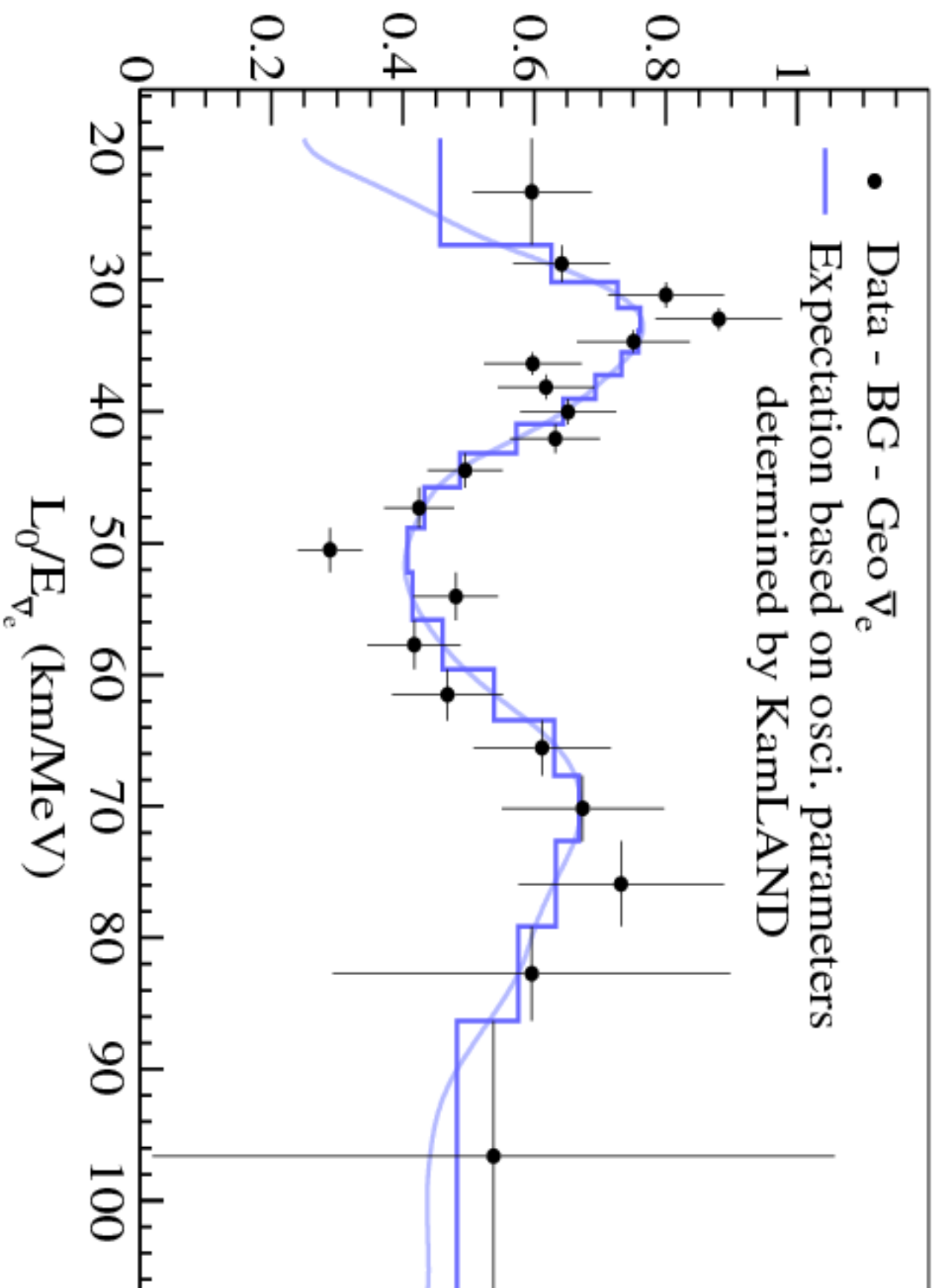

$\nu_e \rightarrow \nu_e$

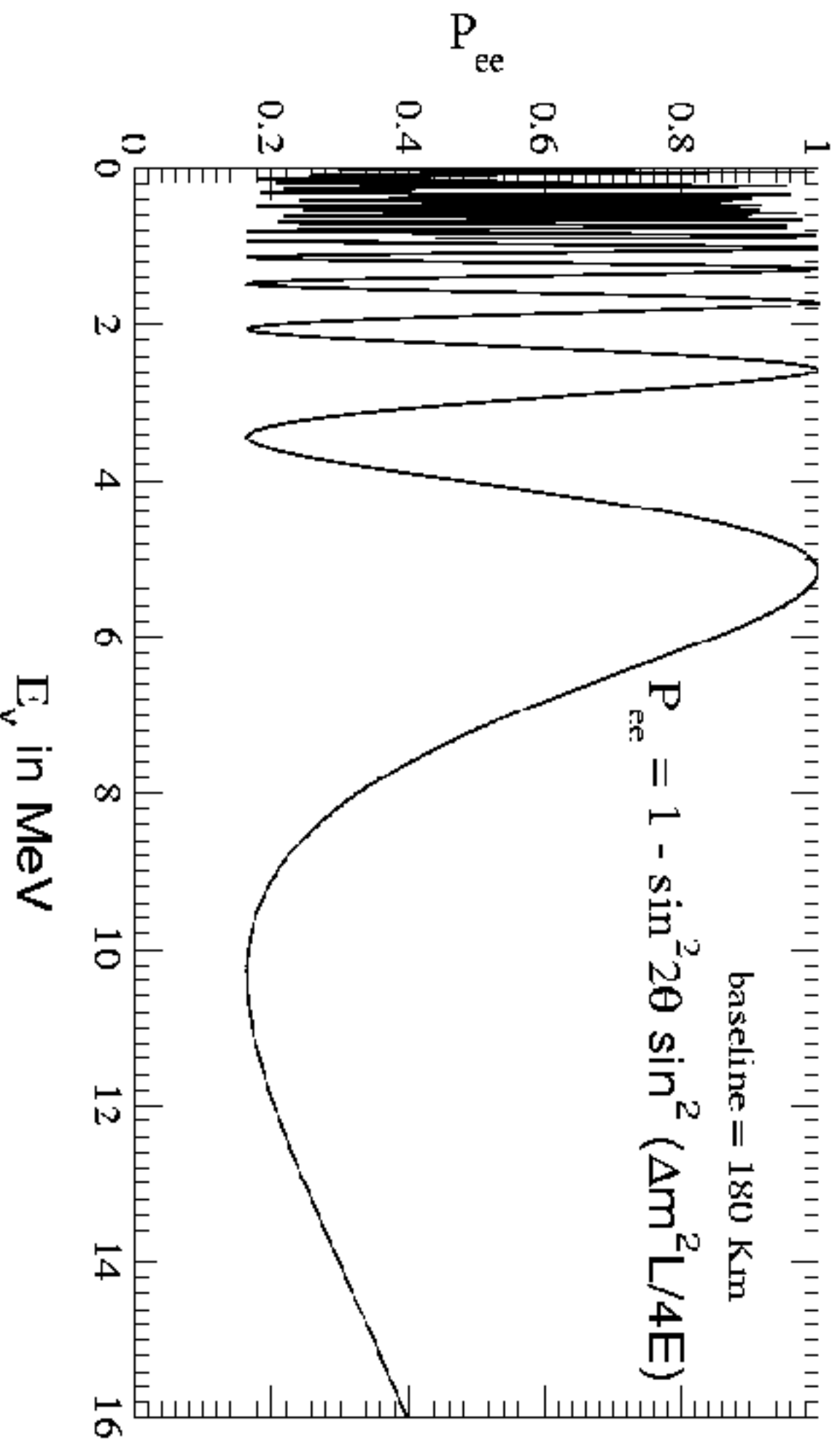

# "solar" parameters

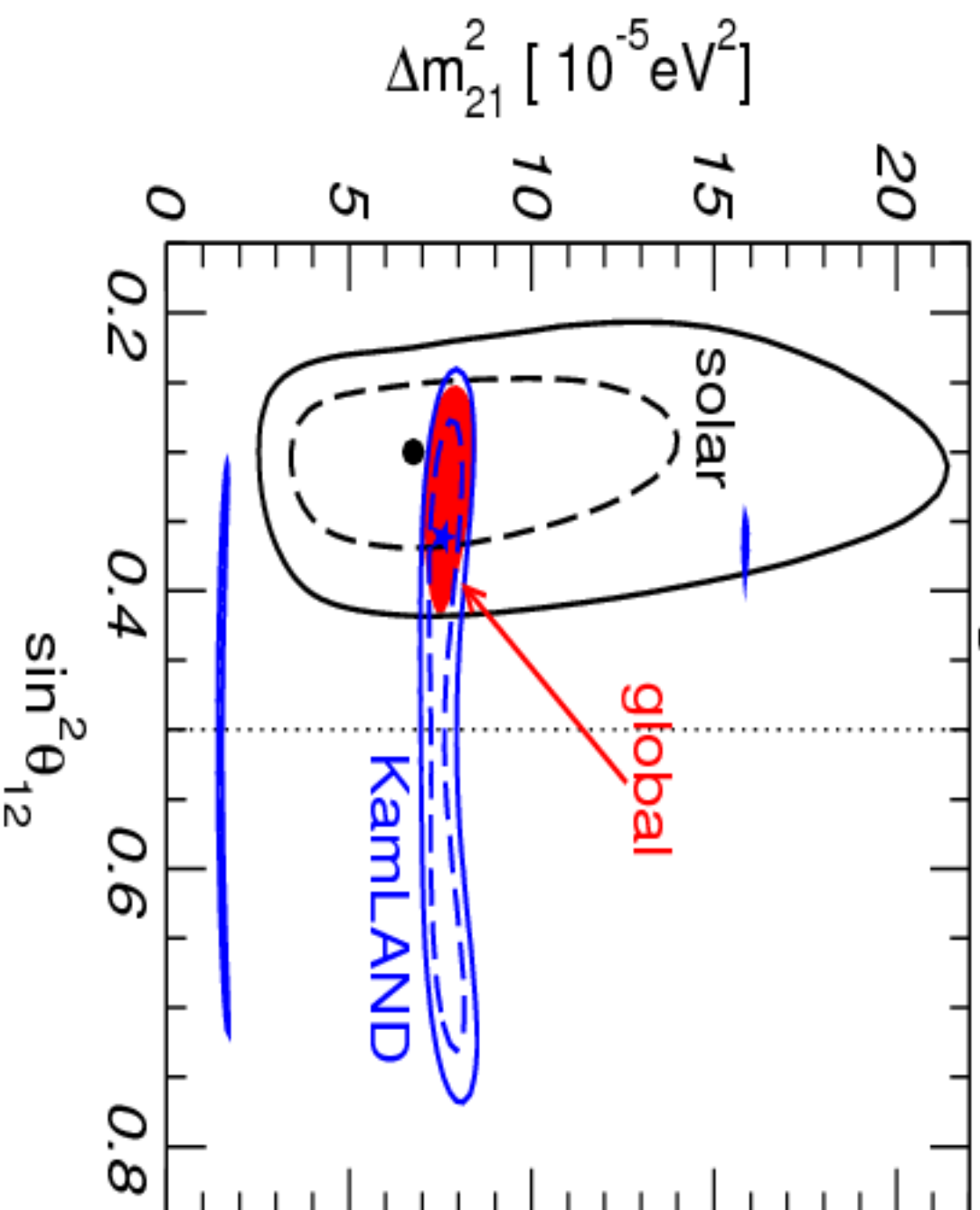

## Matter Effects in Neutrino Oscillations

Matter can affect strongly  $\nu$ -oscillations:

Mean free path in matter with  $\bar{\rho} = \bar{\rho}(Earth)$ :

$E \sim 1$  MeV,  $L_f \sim 5 \times 10^{11}$  km;  $R_E = 6371$  km

$E \sim 1$  GeV,  $L_f \sim 5 \times 10^5$  km

$\nu$  coherent scattering on  $e^-$ ,  $p$ ,  $n$  - effective potential (index of refraction)

$$V_{e\mu} = V(\nu_e) - V(\nu_\mu) = \sqrt{2}G_F N_e$$

$$\bar{V}_{e\mu} = V(\bar{\nu}_e) - V(\bar{\nu}_\mu) = -\sqrt{2}G_F N_e$$

$$V_{\mu\tau} = V(\nu_\mu) - V(\nu_\tau) = 0 \text{ (leading order)}$$

$V_{e\mu} \neq \bar{V}_{e\mu}$ : CP, CPT violated

L. Wolfenstein, 1978; V. Barger et al., 1980; P. Langacker et al., 1983;

S.P. Mikheyev, A.Yu. Smirnov, 1985; etc.

$$i \frac{d}{dt} \begin{pmatrix} A_\alpha(t, t_0) \\ A_\beta(t, t_0) \end{pmatrix} = \begin{pmatrix} -\epsilon(t) & \epsilon'(t) \\ \epsilon'(t) & \epsilon(t) \end{pmatrix} \begin{pmatrix} A_\alpha(t, t_0) \\ A_\beta(t, t_0) \end{pmatrix} \quad (1)$$

where  $\alpha = \nu_e$ ,  $\beta = \nu_{\mu(\tau)}$ .

$$\epsilon(t) = \frac{1}{2} \left[ \frac{\Delta m^2}{2E} \cos 2\theta - \sqrt{2} G_F N_e(t) \right],$$

$$\epsilon'(t) = \frac{\Delta m^2}{4E} \sin 2\theta, \text{ with } \Delta m^2 = m_2^2 - m_1^2.$$

**In matter,  $H_m = H_0 + H_{int}$ .**

$H_0 |\nu_{1,2}\rangle = E_{1,2} |\nu_{1,2}\rangle$ , not eigenstates of  $H_m$ .



Consider first  $N_e = \text{const.}$

$$H_m |\nu_{1,2}^m\rangle = E_{1,2}^m |\nu_{1,2}^m\rangle.$$

Then at  $t = 0$  in matter

$$|\nu_e\rangle = |\nu_1^m\rangle \cos\theta_m + |\nu_2^m\rangle \sin\theta_m,$$

$$|\nu_{\mu(\tau)}\rangle = -|\nu_1^m\rangle \sin\theta_m + |\nu_2^m\rangle \cos\theta_m;$$

$$\sin 2\theta_m = \frac{\epsilon'}{\sqrt{\epsilon'^2 + \epsilon^2}} = \frac{\tan 2\theta}{\sqrt{\left(1 - \frac{N_e}{N_e^{\text{res}}}\right)^2 + \tan^2 2\theta}},$$

$$\cos 2\theta_m = \frac{1 - N_e/N_e^{\text{res}}}{\sqrt{\left(1 - \frac{N_e}{N_e^{\text{res}}}\right)^2 + \tan^2 2\theta}},$$

$$N_e^{\text{res}} = \frac{\Delta m^2 \cos 2\theta}{2E\sqrt{2G_F}} \cong 6.56 \times 10^6 \frac{\Delta m^2 [\text{eV}^2]}{E [\text{MeV}]} \cos 2\theta \text{ cm}^{-3} N_A,$$

$$E_2^m - E_1^m = \frac{\Delta m^2}{2E} \left( \left(1 - \frac{N_e}{N_e^{\text{res}}}\right)^2 \cos^2 2\theta + \sin^2 2\theta \right)^{\frac{1}{2}}$$

$$P_m^{2\nu}(\nu_e \rightarrow \nu_\mu) = |A_\mu(t)|^2 = \frac{1}{2} \sin^2 2\theta_m \left[ 1 - \cos 2\pi \frac{L}{L_m} \right],$$

$$L_m = \frac{E_2^m - E_1^m}{2\pi} = L^{\nu} \left( \left( 1 - \frac{N_e}{N_e^{res}} \right)^2 \cos^2 2\theta + \sin^2 2\theta \right)^{-\frac{1}{2}}.$$

The resonance condition:  $N_e = N_e^{res} = \frac{\Delta m^2 \cos 2\theta}{2E\sqrt{2}G_F}$

At the resonance:

$$\sin^2 2\theta_m = 1, \quad \min(E_2^m - E_1^m), \quad L_m^{res} = L^{\nu} / \sin 2\theta.$$

Limiting cases:

$$N_e \ll N_e^{res}: \quad \theta_m \cong \theta, \quad E_{1,2}^m \cong E_{1,2}, \quad L_m \cong L^{\nu}.$$

$$N_e \gg N_e^{res}: \quad \theta_m \cong \frac{\pi}{2}, \quad \nu_e \rightarrow \nu_\mu \text{ suppressed.}$$

$$\text{In this case: } |\nu_e\rangle \cong |\nu_2^m\rangle, \quad |\nu_\mu\rangle = -|\nu_1^m\rangle.$$

Antineutrinos:  $\bar{\nu}_e \rightarrow (-\bar{\nu}_e)$

$\Delta m^2 \cos 2\theta > 0$ :  $\bar{\nu}_e \rightarrow \bar{\nu}_\mu$  suppressed by matter;  $\nu_e \rightarrow \nu_\mu$  can be enhanced.

$\Delta m^2 \cos 2\theta < 0$ :  $\nu_e \rightarrow \nu_\mu$  suppressed by matter;  $\bar{\nu}_e \rightarrow \bar{\nu}_\mu$  can be enhanced.

Oscillations in matter (Earth, Sun) are neither CP- nor CPT- invariant.

Earth:  $\bar{N}_e^{mant} \sim 2.3 N_A \text{ cm}^{-3}$ ,  $\bar{N}_e^{core} \sim 6.0 N_A \text{ cm}^{-3}$

$P^{m}(\nu_e \rightarrow \nu_\mu; t) = \frac{1}{2} \sin^2 2\theta_m \left(1 - \cos 2\pi \frac{L}{L_{osc}^m}\right)$ ,  $L_{osc}^m \sim L_{osc}^{vac}$

$$\sin^2 2\theta_m = \frac{\sin^2 2\theta}{\left(1 - \frac{N_e}{N_e^{res}}\right)^2 \cos^2 2\theta + \sin^2 2\theta}, \quad N_e^{res} \equiv \frac{\Delta m^2 \cos 2\theta}{2E\sqrt{2}G_F}$$

$N_e = N_e^{res}$ : MSW resonance

$\Delta m^2 \cos 2\theta > 0$ :  $\nu_e \rightarrow \nu_\mu$

$\Delta m^2 \cos 2\theta < 0$ :  $\bar{\nu}_e \rightarrow \bar{\nu}_\mu$

# The Earth

Figure 1

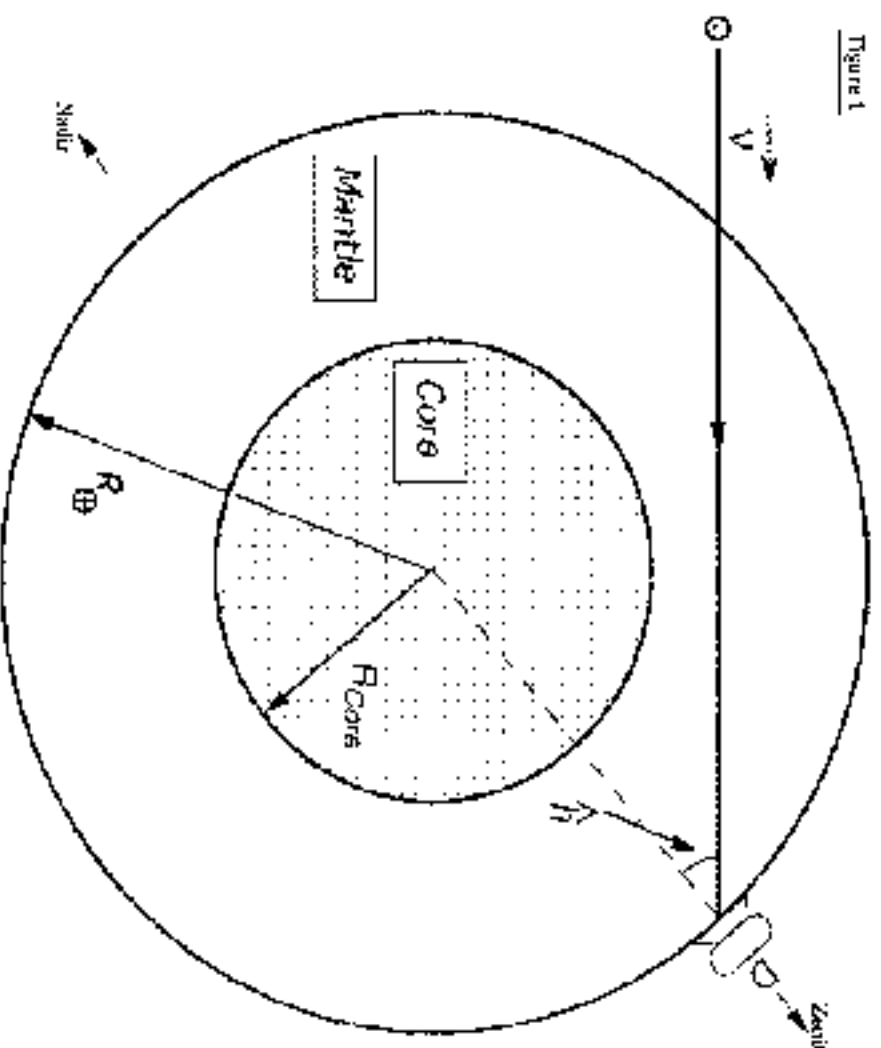

Earth:  $R_{core} = 3446$  km,  $R_{mantle} = 2885$  km

Earth:  $\bar{N}_e^{mant} \sim 2.3 N_A \text{ cm}^{-3}$ ,  $\bar{N}_e^{core} \sim 5.7 N_A \text{ cm}^{-3}$

# The Earth

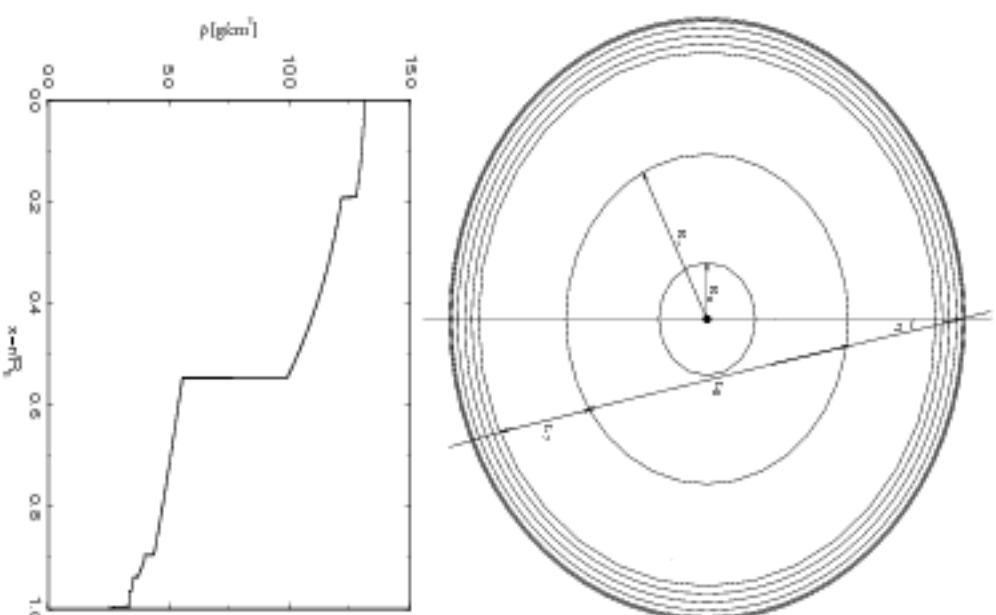
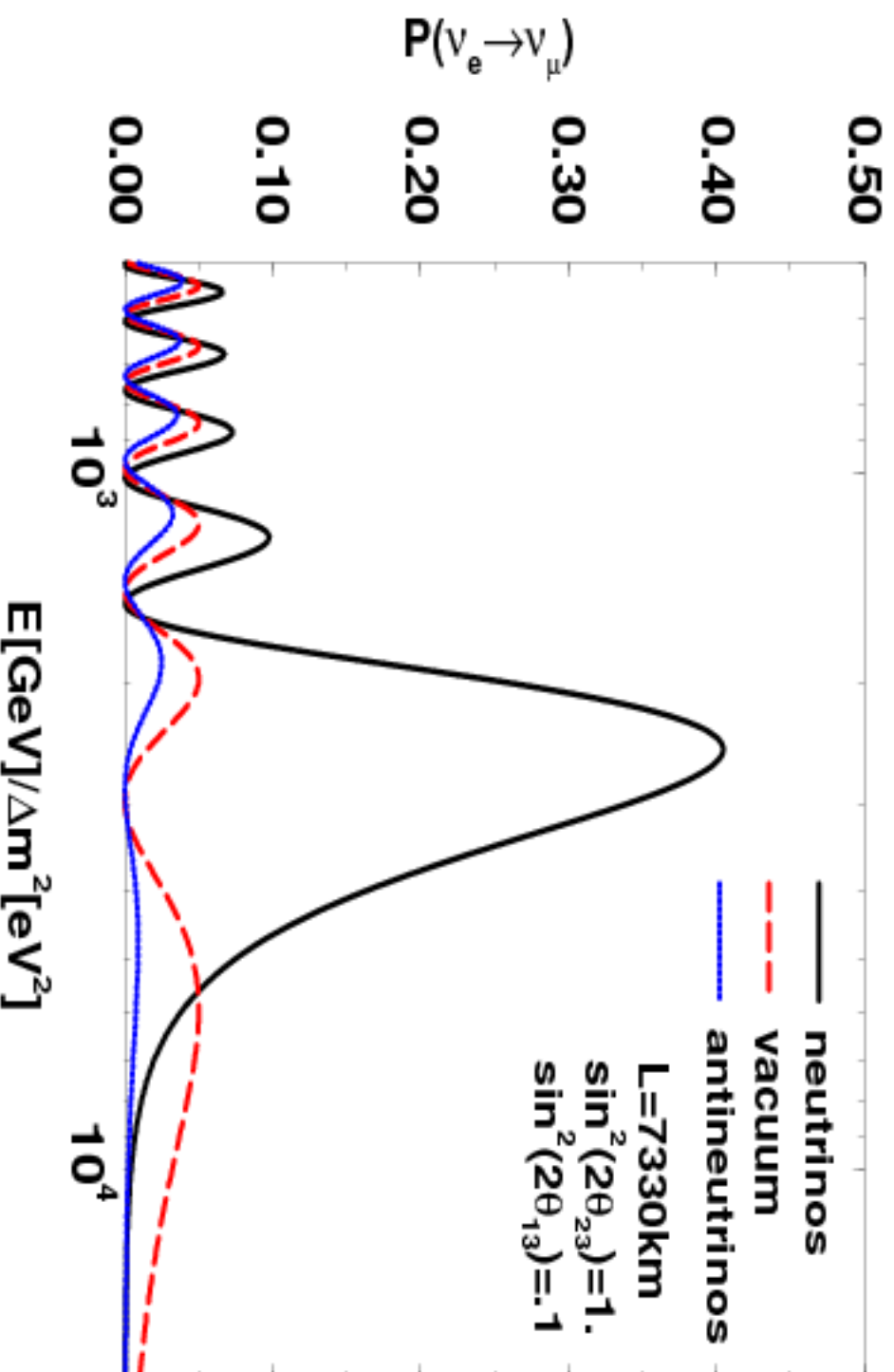

FIG. 1. Density profile of the Earth.

$R_c = 3446$  km,  $R_m = 2885$  km;  $\bar{N}_e^{mant} \sim 2.3 N_A \text{ cm}^{-3}$ ,  $\bar{N}_e^{core} \sim 5.7 N_A \text{ cm}^{-3}$

## Earth matter effect in $\nu_\mu \rightarrow \nu_e, \bar{\nu}_\mu \rightarrow \bar{\nu}_e$ (MSW)



## Earth matter effects in $\nu_\mu \rightarrow \nu_e$ , $\bar{\nu}_\mu \rightarrow \bar{\nu}_e$ (NOLR)

$$\sin^2 2\theta_\nu = 0.010$$

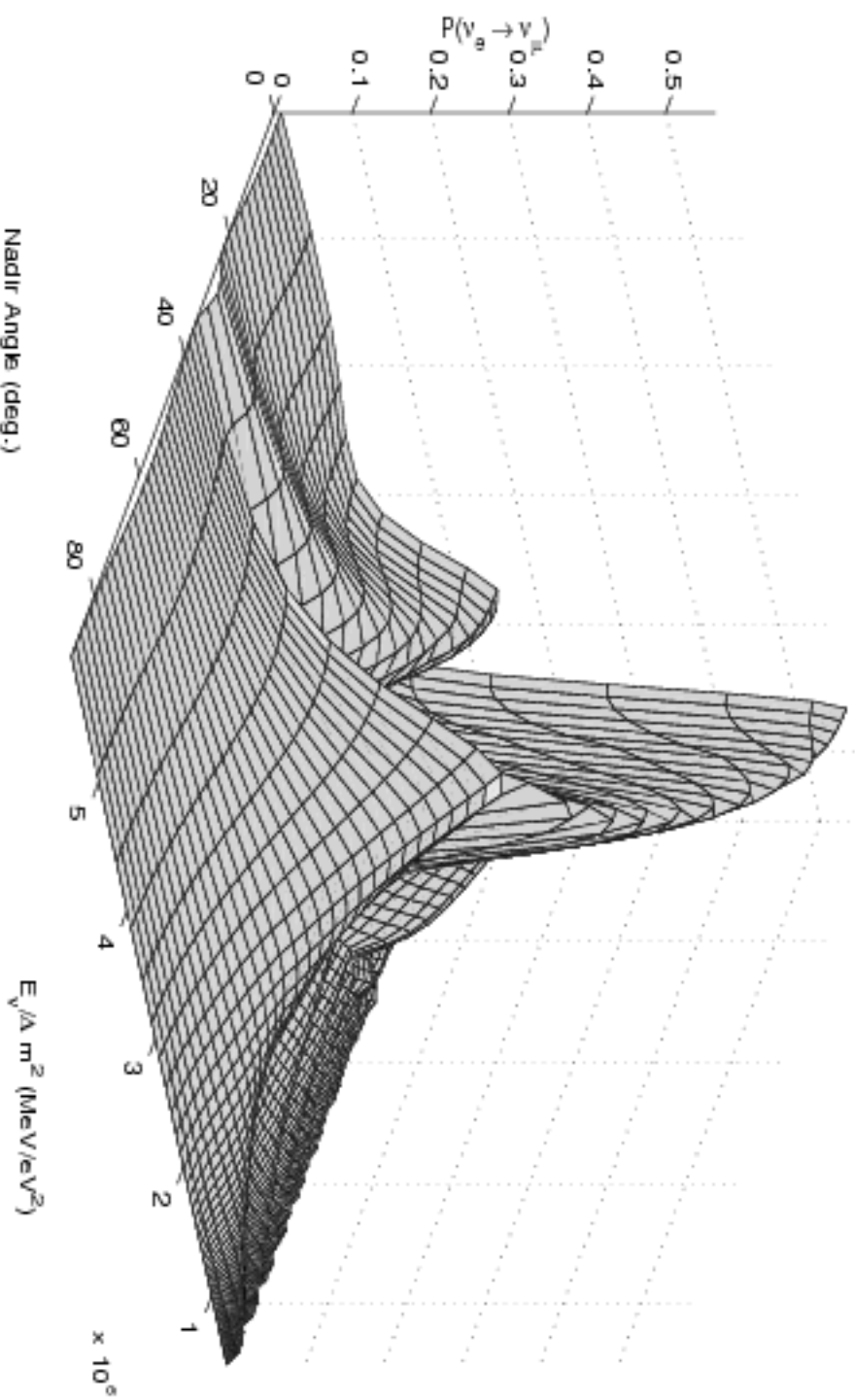

S.T.P., 1998;

M. Chizhov, M. Maris, S.T.P., 1998; M. Chizhov, S.T.P., 1999

$P(\nu_e \rightarrow \nu_\mu) \equiv P_{2\nu} \equiv (s_{23})^{-2} P_{3\nu}(\nu_{e(\mu)} \rightarrow \nu_{\mu(e)})$ ,  $\theta_\nu \equiv \theta_{13}$ ,  $\Delta m^2 \equiv \Delta m_{\text{atm}}^2$ ;

**Absolute maximum: Neutrino Oscillation Length Resonance (NOLR);**

**Local maxima: MSW effect in the Earth mantle or core.**



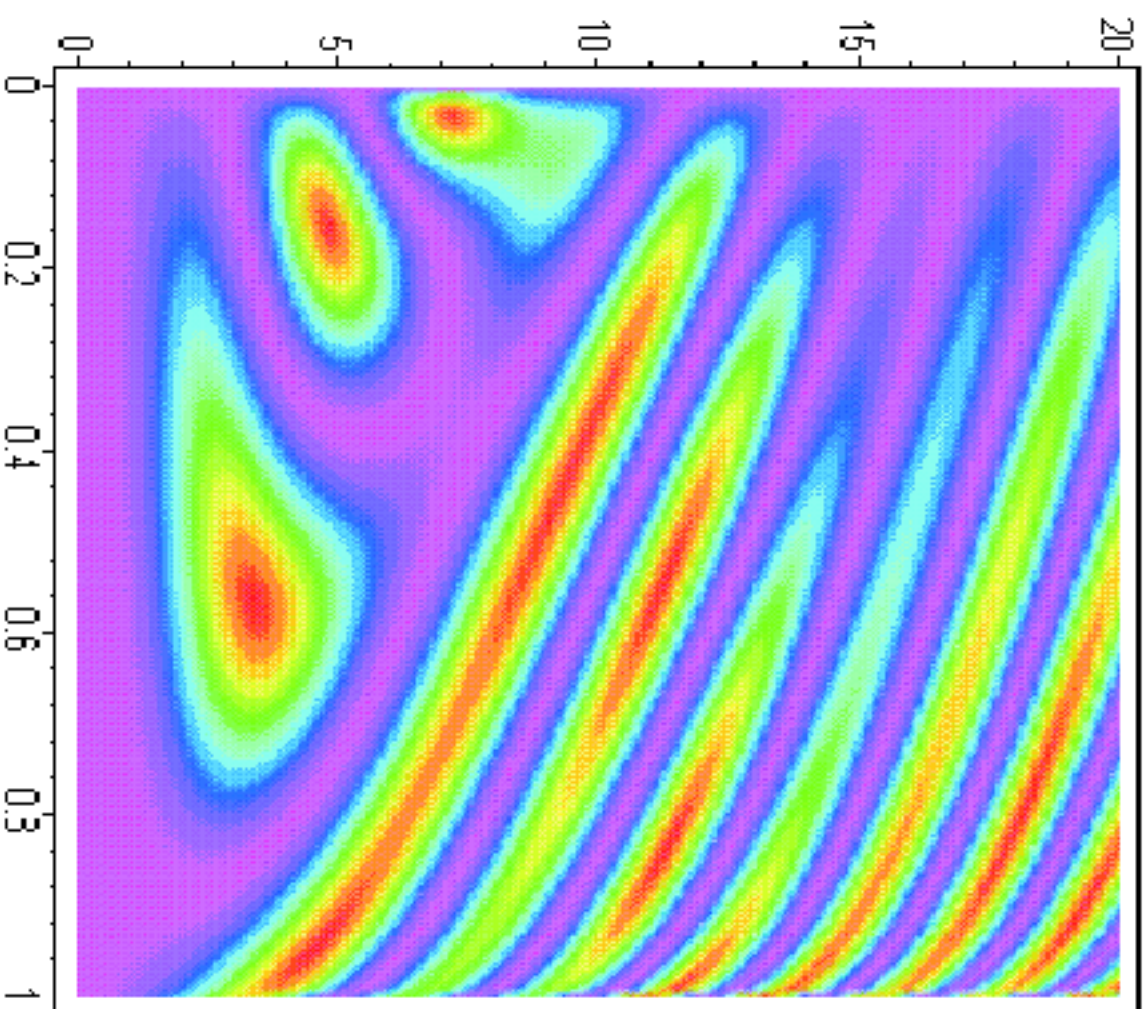

$(s_{23})^{-2} P_{3\nu}(v_{e(\mu)}) \rightarrow v_{\mu(e)} \equiv P_{2\nu}$ ; **NOLR: "Dark Red Spots"**,  $P_{2\nu} = 1$ ;  
**Vertical axis:**  $\Delta m^2/E$  [ $10^{-7} eV^2/MeV$ ]; **horizontal axis:**  $\sin^2 2\theta_{13}$ ;  $\theta_n = 0$

- For Earth center crossing  $\nu$ 's ( $\theta_n = 0$ ) and, e.g.  $\sin^2 2\theta_{13} = 0.01$ , **NOLR** occurs at  $E \cong 4$  **GeV** ( $\Delta m^2(\text{atm}) = 2.5 \times 10^{-3} \text{ eV}^2$ ).
- For the Earth core crossing  $\nu$ 's:  $P_{2\nu} = 1$  **due to NOLR** when

$$\tan \Phi_{\text{man}}/2 \equiv \tan \phi' = \pm \sqrt{\frac{-\cos 2\theta''_m}{\cos(2\theta''_m - 4\theta'_m)}}$$

$$\tan \Phi_{\text{core}}/2 \equiv \tan \phi'' = \pm \sqrt{\frac{\cos 2\theta'_m}{-\cos(2\theta''_m) \cos(2\theta'_m - 4\theta'_m)}}$$

$\Phi_{\text{man}}$  ( $\Phi_{\text{core}}$ ) - phase accumulated in the Earth mantle (core),  
 $\theta'_m$  ( $\theta''_m$ ) - the mixing angle in the Earth mantle (core).

$P_{2\nu} = 1$  **due to NOLR** for  $\theta_n = 0$  (Earth center crossing  $\nu$ 's) at,  
 e.g.  $\sin^2 2\theta_{13} = 0.034$ ; 0.154,  $E \cong 3.5$ ; 5.2 **GeV** ( $\Delta m^2(\text{atm}) = 2.5 \times 10^{-3} \text{ eV}^2$ ).

M. Chizhov, S.T.P., Phys. Rev. Lett. 83 (1999) 1096 (hep-ph/9903399); Phys. Rev. Lett. 85 (2000) 3979 (hep-ph/0504247); Phys. Rev. D63 (2001) 073003 (hep-ph/9903424).

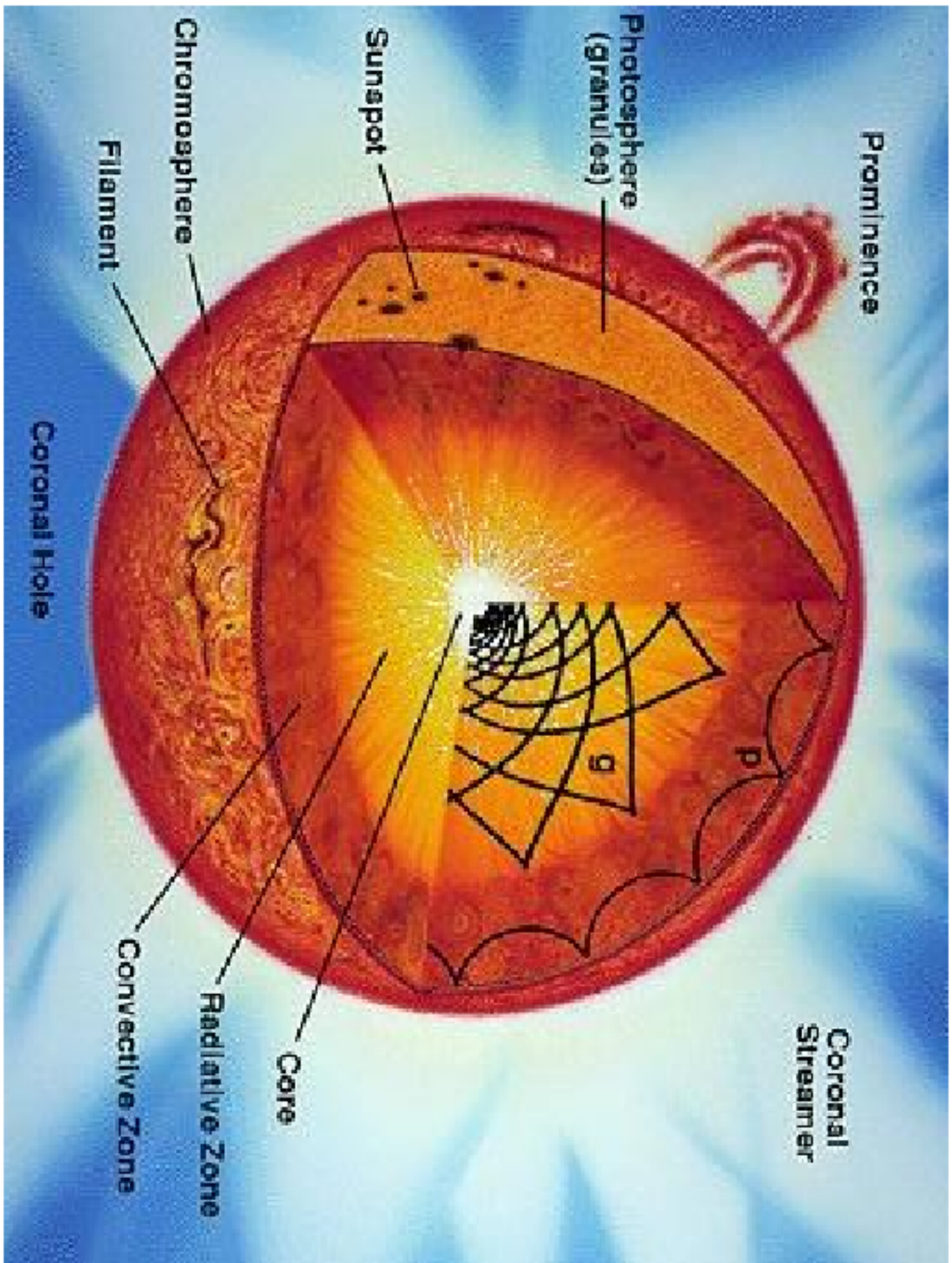

## Solar Neutrino Production: pp Chain

REACTION	TERM. (%)	ENERGY (MeV)
$p + p \rightarrow {}^2\text{H} + e^+ + \nu_e$	(99.96)	$\leq 0.420$
or		
$p + e + p \rightarrow {}^3\text{H} + \nu_e$	(0.14)	1.442
$2\text{H} + p \rightarrow {}^3\text{He} + \gamma$	(100)	
${}^3\text{He} + {}^3\text{He} \rightarrow \alpha + 2p$	(85)	
or		
${}^3\text{He} + {}^4\text{He} \rightarrow {}^7\text{Be} + \gamma$	(15)	
${}^7\text{Be} + e^- \rightarrow {}^7\text{Li} + \nu_e$	(15)	$\begin{cases} 0.861 & 90\% \\ 0.383 & 10\% \end{cases}$
${}^7\text{Li} + p \rightarrow 2\alpha$		
or		
${}^7\text{Be} + p \rightarrow {}^8\text{B} + \gamma$	(0.02)	
${}^8\text{B} \rightarrow {}^8\text{Be}^* + e^- + \nu_e$		$< 13$
${}^8\text{Be}^* \rightarrow 2\alpha$		
or		
${}^3\text{He} + p \rightarrow {}^4\text{He} + e^+ + \nu_e$	(0.000004)	18.8



- $pp$  neutrinos,  $E \leq 0.420$  MeV,  $\bar{E} = 0.265$  MeV,
- ${}^7\text{Be}$  neutrinos,  $E = 0.862$  MeV (89.7% of the flux),  $0.384$  MeV (10.3%) ,
- ${}^8\text{B}$  neutrinos,  $E \leq 14.40$  MeV,  $\bar{E} = 6.71$  MeV,
- $pep$  neutrinos,  $E = 1.442$  MeV,
- of  ${}^{13}\text{N}$ ,  $E \leq 1.199$  MeV,  $\bar{E} = 0.707$  MeV,
- of  ${}^{15}\text{O}$ ,  $E \leq 1.732$  MeV,  $\bar{E} = 0.997$  MeV.

Flux	BP'00	CI-Ar	Ga-Ge
$\Phi_{pp} \times 10^{-10}$	5.95(1 <sup>+0.01</sup> <sub>-0.01</sub> )	0.00	69.7
$\Phi_{pep} \times 10^{-8}$	1.40(1 <sup>+0.01</sup> <sub>-0.01</sub> )	0.22	2.8
$\Phi_{Be} \times 10^{-9}$	4.77(1 <sup>+0.09</sup> <sub>-0.09</sub> )	1.15	34.2
$\Phi_B \times 10^{-6}$	5.93(1 <sup>+0.14</sup> <sub>-0.15</sub> )	6.76	14.2
$\Phi_N \times 10^{-8}$	5.48(1 <sup>+0.19</sup> <sub>-0.13</sub> )	0.09	3.4
$\Phi_O \times 10^{-8}$	4.80(1 <sup>+0.22</sup> <sub>-0.15</sub> )	0.33	5.5
Total		8.55 <sup>+1.1</sup> <sub>-1.2</sub>	129.8 <sup>+9</sup> <sub>-7</sub>



**Solar Neutrinos**  $\nu_e$ ,  $E \sim 1$  MeV: **B. Pontecorvo 1946**



R. Davis et al., 1967 - 1996: 615 t  $\text{C}_2\text{Cl}_4$ ; 0.5 Ar atoms/day, exposure 60 days.



Kamiokande (1986-1994), Super-Kamiokande (1996 -), SNO (2000 - 2006), BOREXINO (2007 - );



Super-Kamiokande: 50000t ultra-pure water;

SNO: 1000t heavy water ( $D_2O$ )



SAGE (60t), 1990-; GALLEX/GNO (30t, LNGS), 1991-2003



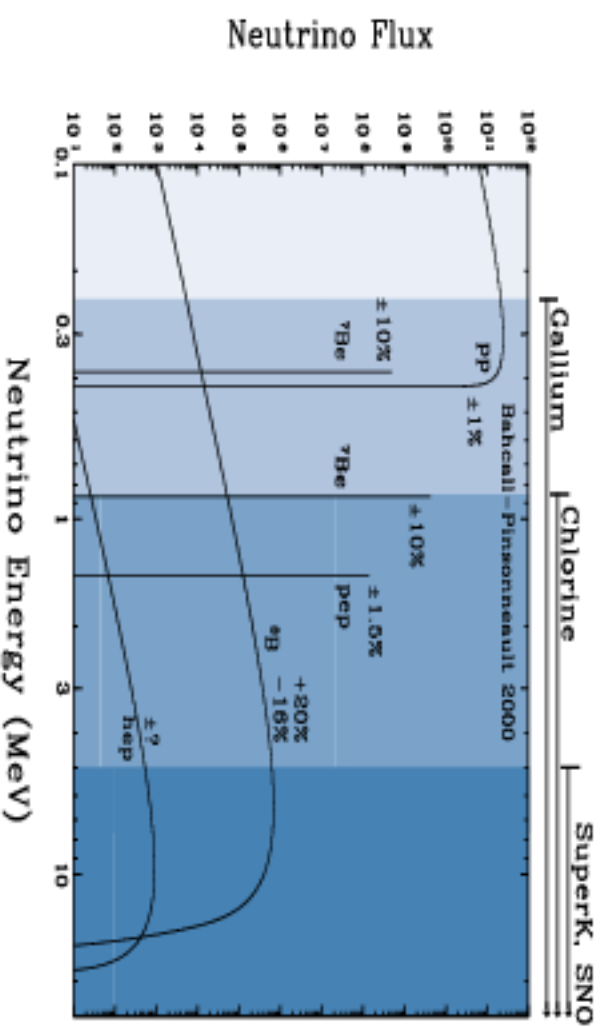

Figure 2: Differential Standard Solar Model neutrino fluxes [14].

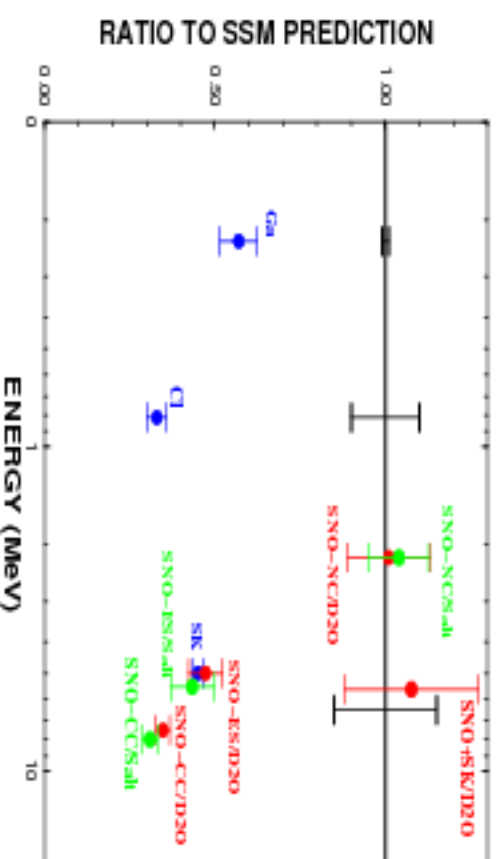
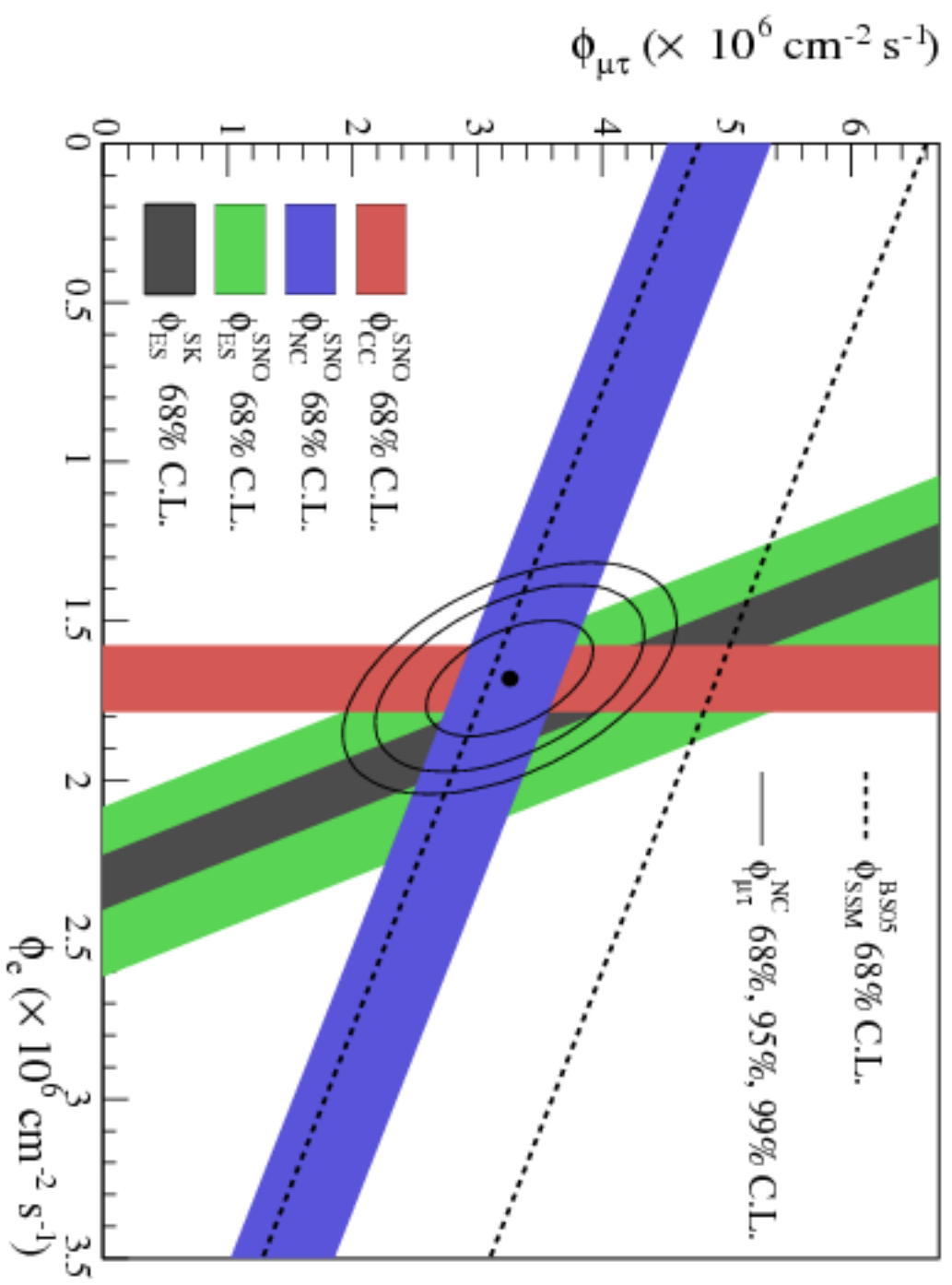

Figure 3: Comparison of measurements to Standard Solar Model predictions.

Flux	BP'00	CI-Ar	Ga-Ge
$\Phi_{pp} \times 10^{-10}$	5.95(1 <sup>+0.01</sup> <sub>-0.01</sub> )	0.00	69.7
$\Phi_{pep} \times 10^{-8}$	1.40(1 <sup>+0.01</sup> <sub>-0.01</sub> )	0.22	2.8
$\Phi_{Be} \times 10^{-9}$	4.77(1 <sup>+0.09</sup> <sub>-0.09</sub> )	1.15	34.2
$\Phi_B \times 10^{-6}$	5.93(1 <sup>+0.14</sup> <sub>-0.15</sub> )	6.76	14.2
$\Phi_N \times 10^{-8}$	5.48(1 <sup>+0.19</sup> <sub>-0.13</sub> )	0.09	3.4
$\Phi_O \times 10^{-8}$	4.80(1 <sup>+0.22</sup> <sub>-0.15</sub> )	0.33	5.5
Total		8.55 <sup>+1.1</sup> <sub>-1.2</sub>	129.8 <sup>+9</sup> <sub>-7</sub>

Experiment	Observed rate/BP04 prediction	Predicted Rate at global best-fit	Predicted Rate at solar best-fit
Ga	$0.52 \pm 0.029$	0.555	0.540
Cl	$0.301 \pm 0.027$	0.356	0.345
SK(ES)	$0.406 \pm 0.014$	0.394	0.395
SNO(CC)	$0.274 \pm 0.019$	0.289	0.289
SNO(ES)	$0.38 \pm 0.052$	0.386	0.386
SNO(NC)	$0.895 \pm 0.08$	0.889	0.908

The observed rates w.r.t predictions from the latest Standard Solar Model BP04. Shown are also the predicted rates for the best fit values of  $\Delta m_{21}^2$  and  $\sin^2 \theta_{12}$ , obtained in the analysis of the i) global solar neutrino data, and ii) global solar neutrino +KamLAND data.



## MSW Transitions of Solar Neutrinos in the Sun and the Hydrogen Atom

$$i \frac{d}{dt} \begin{pmatrix} A_\alpha(t, t_0) \\ A_\beta(t, t_0) \end{pmatrix} = \begin{pmatrix} -\epsilon(t) & \epsilon'(t) \\ \epsilon'(t) & \epsilon(t) \end{pmatrix} \begin{pmatrix} A_\alpha(t, t_0) \\ A_\beta(t, t_0) \end{pmatrix} \quad (2)$$

where  $\alpha = \nu_e$ ,  $\beta = \nu_\mu(\tau)$ .

$$\epsilon(t) = \frac{1}{2} \left[ \frac{\Delta m^2}{2E} \cos 2\theta - \sqrt{2} G_F N_e(t) \right],$$

$$\epsilon'(t) = \frac{\Delta m^2}{4E} \sin 2\theta, \text{ with } \Delta m^2 = m_2^2 - m_1^2.$$

- **Standard Solar Models**

$$N_e(t) = N_e(t_0) \exp \left\{ -\frac{t-t_0}{r_0} \right\}, \quad r_0 \sim 0.1 R_\odot, \quad R_\odot = 6.96 \times 10^5 \text{ km}$$

The region of  $\nu_{\odot}$  production:  $r \lesssim 0.2R_{\odot}$

$$20 N_A \text{ cm}^{-3} \lesssim N_e(x_0) \lesssim 100 N_A \text{ cm}^{-3}$$

Suppose  $N_e(x_0) \gg N_e^{res}$ :  $|\nu_e\rangle \cong |\nu_2^m\rangle$ .

Possible evolution:

The system stays at this level; at the surface:  $|\nu_2^m\rangle = |\nu_2\rangle$

$$P(\nu_e \rightarrow \nu_e) \cong |\langle \nu_e | \nu_2 \rangle|^2 = \sin^2 \theta, \quad \text{Adiabatic}$$

At  $N_e \equiv N_e^{res}$ , where  $E_2^m - E_1^m$  is minimal, the system jumps to lower level  $|\nu_1^m\rangle$ ; at the surface:  $|\nu_1^m\rangle = |\nu_1\rangle$

$$P(\nu_e \rightarrow \nu_e) \cong |\langle \nu_e | \nu_1 \rangle|^2 = \cos^2 \theta, \quad \text{Nonadiabatic}$$

Type of transition:  $P^l \equiv P(\nu_2^m(t_0) \rightarrow \nu_1)$ , jump probability

Introducing the dimensionless variable

$$Z = ir_0 \sqrt{2G_F N_e(t_0)} e^{-\frac{t-t_0}{r_0}}, \quad Z_0 = Z(t = t_0),$$

and making the substitution

$$A_e(t, t_0) = (Z/Z_0)^{c-a} e^{-\int_{t_0}^t \epsilon(t') dt'} A'_e(t, t_0),$$

$A'_e(t, t_0)$  satisfies the confluent hypergeometric equation (CHE):

$$\left\{ Z \frac{d^2}{dZ^2} + (c - Z) \frac{d}{dZ} - a \right\} A'_e(t, t_0) = 0,$$

where

$$a = 1 + ir_0 \frac{\Delta m^2}{2E} \sin^2 \theta, \quad c = 1 + ir_0 \frac{\Delta m^2}{2E}.$$

The confluent hypergeometric equation describing the  $\nu_e$  oscillations in the Sun, coincides in form with the Schrodinger (energy eigenvalue) equation obeyed by the radial part,  $\psi_{kl}(\tau)$ , of the non-relativistic wave function of the hydrogen atom,

$$\Psi(\vec{r}) = \frac{1}{r} \psi_{kl}(\tau) Y_{lm}(\theta', \phi'),$$

$\tau$ ,  $\theta'$  and  $\phi'$  are the spherical coordinates of the electron in the proton's rest frame,  $l$  and  $m$  are the orbital momentum quantum numbers ( $m = -l, \dots, l$ ),  $k$  is the quantum number labeling (together with  $l$ ) the electron energy (the principal quantum number is equal to  $(k+l)$ ),  $E_{kl}$  ( $E_{kl} < 0$ ), and  $Y_{lm}(\theta', \phi')$  are the spherical harmonics. The function

$$\psi'_{kl}(Z) = Z^{-c/2} e^{Z/2} \psi_{kl}(\tau)$$

satisfies the confluent hypergeometric equation in which the variable  $Z$  and the parameters  $a$  and  $c$  are in this case related to the physical quantities characterizing the hydrogen atom:

$$Z = 2 \frac{r}{a_0} \sqrt{-E_{kl}/E_I}, \quad a \equiv a_{kl} = l+1 - \sqrt{-E_I/E_{kl}}, \quad c \equiv c_l = 2(l+1),$$

$a_0 = \hbar/(m_e e^2)$  is the Bohr radius and  $E_I = m_e e^4/(2\hbar^2) \cong 13.6 \text{ eV}$  is the ionization energy of the hydrogen atom.



Quite remarkably, the behavior of such different physical systems as solar neutrinos undergoing MSW transitions in the Sun and the non-relativistic hydrogen atom are governed by one and the same differential equation.

Any solution - linear combination of two linearly independent solutions:

$\Phi(a, c; Z)$ ,  $Z^{1-c} \Phi(a - c + 1, 2 - c; Z)$ ;  $\Phi(a', d; Z = 0) = 1$ ,  $a', d \neq 0, -1, -2, \dots$

$$A(\nu_e \rightarrow \nu_{\mu}(\tau)) = \frac{1}{2} \sin 2\theta \left\{ \Phi(a - c, 2 - c; Z_0) - e^{i(t-t_0)\frac{\Delta m^2}{2E}} \Phi(a - 1, c; Z_0) \right\}.$$

Sun:  $N_e(x) \cong N_e(x_0)e^{-\frac{x}{\tau_0}}$ ,  $\tau_0 \cong 0.1R_{\odot}$ ,  $R_{\odot} \cong 7 \times 10^5$  km

The region of  $\nu_{\odot}$  production:

$20 N_A \text{ cm}^{-3} \lesssim N_e(x_0) \lesssim 100 N_A \text{ cm}^{-3}$ :  $|Z_0| > 500$  (!)

The solar  $\nu_e$  survival probability:

$$\bar{P}(\nu_e \rightarrow \nu_e) = \frac{1}{2} + \left(\frac{1}{2} - P'\right) \cos 2\theta_m^0 \cos 2\theta,$$

$$P' = \frac{e^{-2\pi\tau_0\frac{\Delta m^2}{2E}} \sin^2 \theta - e^{-2\pi\tau_0\frac{\Delta m^2}{2E}}}{1 - e^{-2\pi\tau_0\frac{\Delta m^2}{2E}}}$$

$\nu_e \rightarrow \nu_e$

Averaged Survival Probability in the Sun

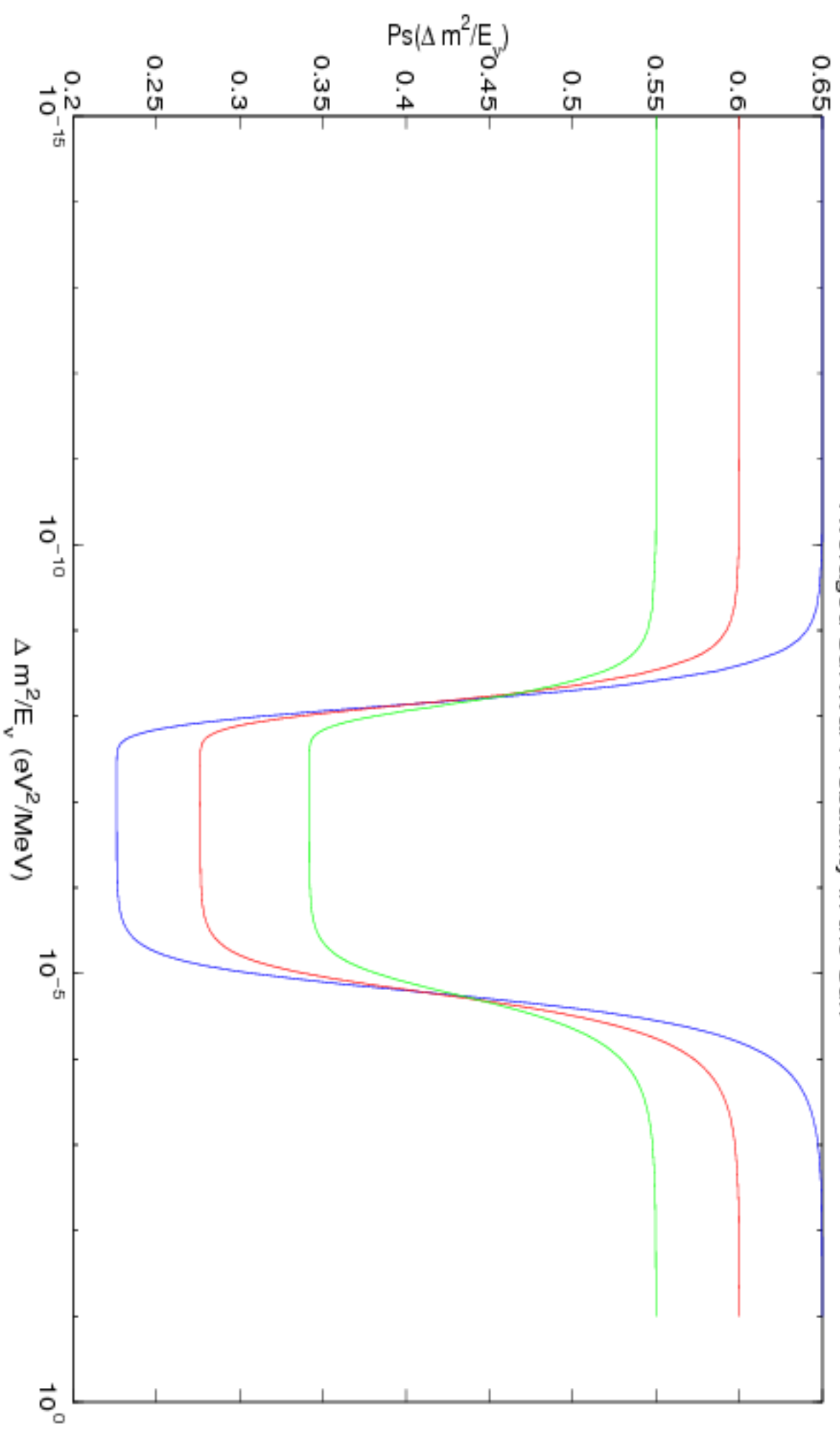

The solar  $\nu_e$  survival probability:

$$\bar{P}(\nu_e \rightarrow \nu_e) = \frac{1}{2} + \left(\frac{1}{2} - P'\right) \cos 2\theta_m^0 \cos 2\theta,$$

$$P' = \frac{e^{-2\pi r_0 \frac{\Delta m^2}{2E}} \sin^2 \theta - e^{-2\pi r_0 \frac{\Delta m^2}{2E}}}{1 - e^{-2\pi r_0 \frac{\Delta m^2}{2E}}}$$

Case 1:  $\cos 2\theta_m^0 = -1$ ,  $P' = 0$ ,  $\bar{P} = \frac{1}{2}(1 - \cos 2\theta)$ .

Case 2:  $\theta_m^0 = \theta$ ,  $P' = 0$ ,  $\bar{P}(\nu_e \rightarrow \nu_e) = 1 - \frac{1}{2} \sin^2 2\theta$

Case 1: SNO, Super Kamiokande;  $\bar{P} \cong 0.3$ :  $\cos 2\theta > 0$ !

Case 2:  $pp$  neutrinos.

## PMNS Matrix: Standard Parametrization

$$U = VP, \quad P = \begin{pmatrix} 1 & 0 & 0 \\ 0 & e^{i\frac{\alpha_{21}}{2}} & 0 \\ 0 & 0 & e^{i\frac{\alpha_{31}}{2}} \end{pmatrix},$$

$$V = \begin{pmatrix} c_{12}c_{13} & s_{12}c_{13} & s_{13}e^{-i\delta} \\ -s_{12}c_{23} - c_{12}s_{23}s_{13}e^{i\delta} & c_{12}c_{23} - s_{12}s_{23}s_{13}e^{i\delta} & s_{23}c_{13} \\ s_{12}s_{23} - c_{12}c_{23}s_{13}e^{i\delta} & -c_{12}s_{23} - s_{12}c_{23}s_{13}e^{i\delta} & c_{23}c_{13} \end{pmatrix}$$

- $s_{ij} \equiv \sin \theta_{ij}$ ,  $c_{ij} \equiv \cos \theta_{ij}$ ,  $\theta_{ij} = [0, \frac{\pi}{2}]$ ,
- $\delta$  - Dirac CP-violation phase,  $\delta = [0, 2\pi]$ ,
- $\alpha_{21}$ ,  $\alpha_{31}$  - the two Majorana CP-violation phases.

S.M. Bilenky, J. Hosek, S.T.P., 1980

- $\Delta m_{\odot}^2 \equiv \Delta m_{21}^2 \cong 7.59 \times 10^{-5} \text{ eV}^2 > 0$ ,  $\sin^2 \theta_{12} \cong 0.318$ ,  $\cos 2\theta_{12} \gtrsim 0.26$  ( $3\sigma$ ),
- $|\Delta m_{\text{atm}}^2| \equiv |\Delta m_{31}^2| \cong 2.4 \times 10^{-3} \text{ eV}^2$ ,  $\sin^2 2\theta_{23} \cong 1$ ,
- $\theta_{13}$  - the CHOOZ angle:  $\sin^2 \theta_{13} < 0.031$  (0.047)  $2\sigma$  ( $3\sigma$ ) (see further).

Mezzetto, Schwetz *et al.*, arXiv:1003.5800

### 3- $\nu$ Mixing Analysis: $\Delta m_{\odot}^2 \ll |\Delta m_{\text{atm}}^2|$

$$P_{\odot}^{3\nu} \cong \sin^4 \theta_{13} + \cos^4 \theta_{13} \quad P_{\odot}^{2\nu},$$

$$P_{\odot}^{2\nu} = \bar{P}_{\odot}^{2\nu} + P_{\odot}^{2\nu} \text{osc},$$

$$\bar{P}_{\odot}^{2\nu} = \frac{1}{2} + \left(\frac{1}{2} - P'\right) \cos 2\theta_{12}^m(t_0) \cos 2\theta_{12} \quad (\theta_{12} \equiv \theta_{\odot}),$$

$P' = 0$ : L. Wolfenstein, 1978; S. Mikheyev, A. Smirnov, 1985;

$P' \neq 0$  (general or LZ): S. Parke, W. Haxton, 1986;

$P'$ -double exponential,  $P_{\odot}^{2\nu} \text{osc}$ : S.T.P., 1988

$$N_e \rightarrow N_e \cos^2 \theta_{13},$$

$$P' = \frac{e^{-2\pi\tau_0 \frac{\Delta m_{\odot}^2}{2E}} \sin^2 \theta_{12} - e^{-2\pi\tau_0 \frac{\Delta m_{\odot}^2}{2E}}}{1 - e^{-2\pi\tau_0 \frac{\Delta m_{\odot}^2}{2E}}}, \quad \tau_0 \sim 0.1 R_{\odot}$$

S.T.P., 1988

$$\text{LMA: } P' \ll 1, \quad < P_{\odot}^{2\nu} \text{osc} > \cong 0$$

J. Rich, S.T.P., 1988

$$P_{\text{KL}}^{3\nu} \cong \sin^4 \theta_{13} + \cos^4 \theta_{13} \left[ 1 - \sin^2 2\theta_{12} \sin^2 \left( \frac{\Delta m_{\odot}^2}{4E} L \right) \right]$$

$$P_{\text{CHOOZ}}^{3\nu} \cong 1 - \sin^2 2\theta_{13} \sin^2 \left( \frac{\Delta m_{\text{atm}}^2}{4E} L \right)$$

# "solar" parameters

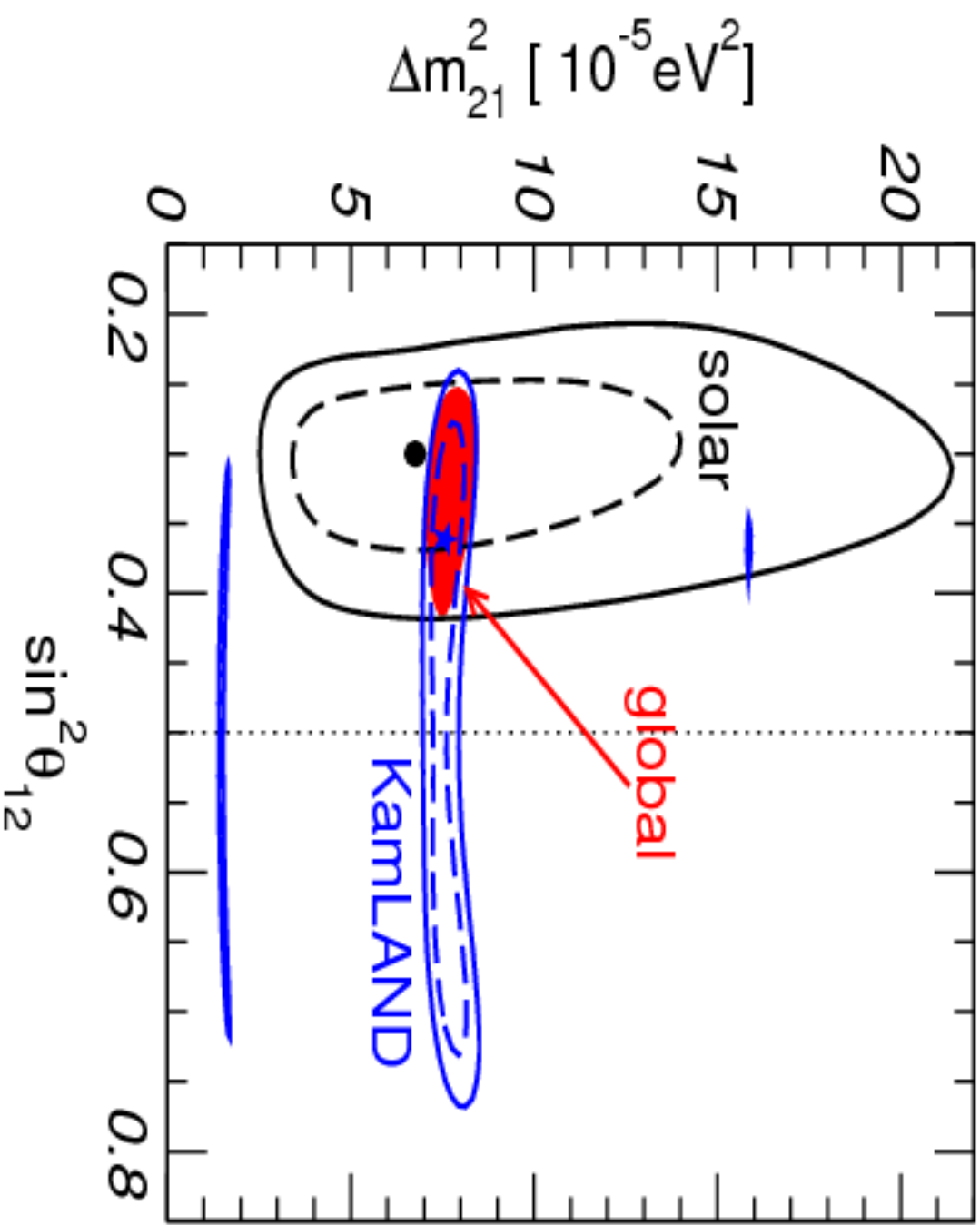

## "atmospheric" parameters

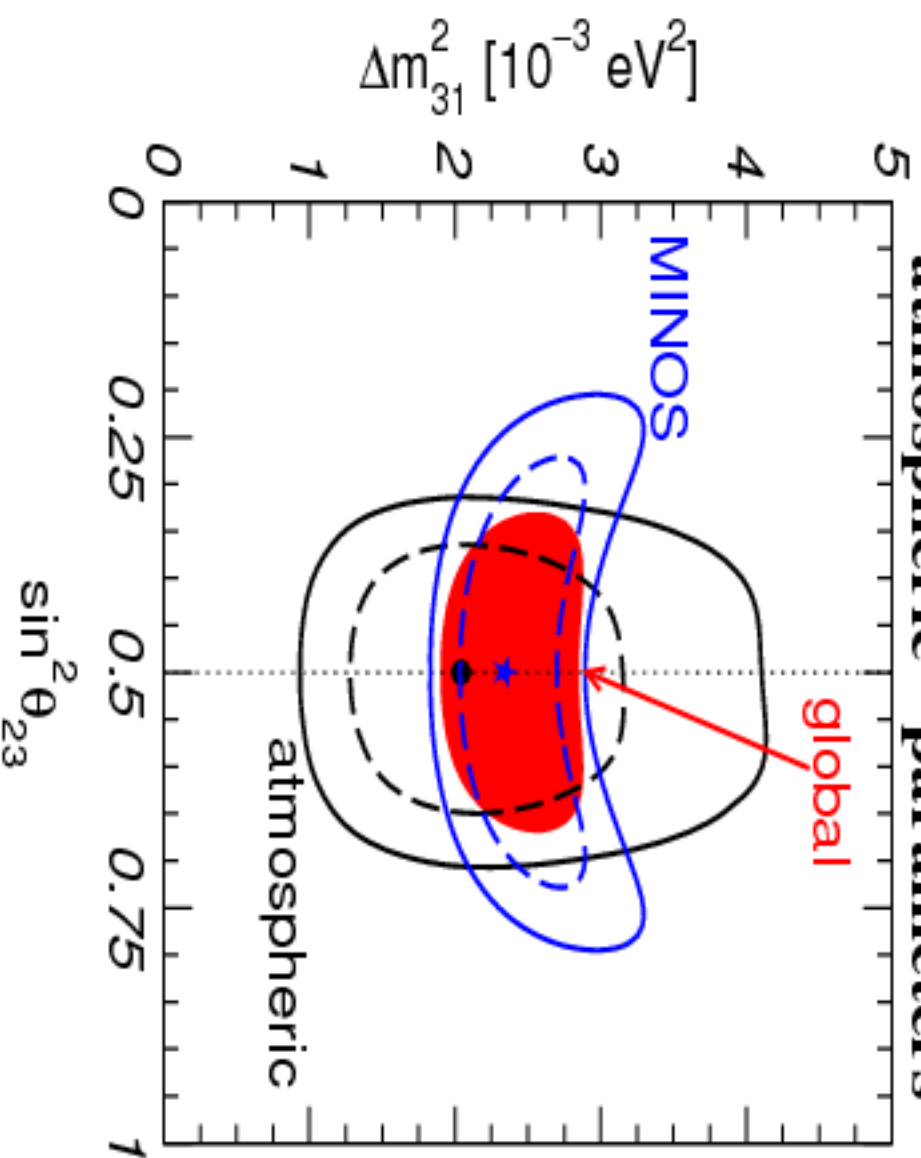

T. Schwetz, [arXiv:0710.5027](https://arxiv.org/abs/0710.5027) [hep-ph]

- sign of  $\Delta m_{\text{atm}}^2$  not determined;

3- $\nu$  mixing:  $\Delta m_{31}^2 > 0$ ,  $m_1 < m_2 < m_3$  (normal ordering (NO));

$\Delta m_{31}^2 < 0$ ,  $m_3 < m_1 < m_2$  (Inverted ordering (IO)).

- If  $\theta_{23} \neq \frac{\pi}{4}$ :  $\theta_{23}$ ,  $(\frac{\pi}{4} - \theta_{23})$  ambiguity.



$$\sin^2 \theta_{13} = 0.016 \pm 0.010, \quad \sin \theta_{13} = (0.077 - 0.161), \quad 1\sigma$$

E. Lisi *et al.*, arXiv:0806.2649

Atmospheric  $\nu$  data:  $\cos \delta = -1$  favored over  $\cos \delta = +1$

J. Escamilla *et al.*, arXiv:0805.2924

New data from T2K and MINOS (June 2011), to be discussed further, strengthen these indications.

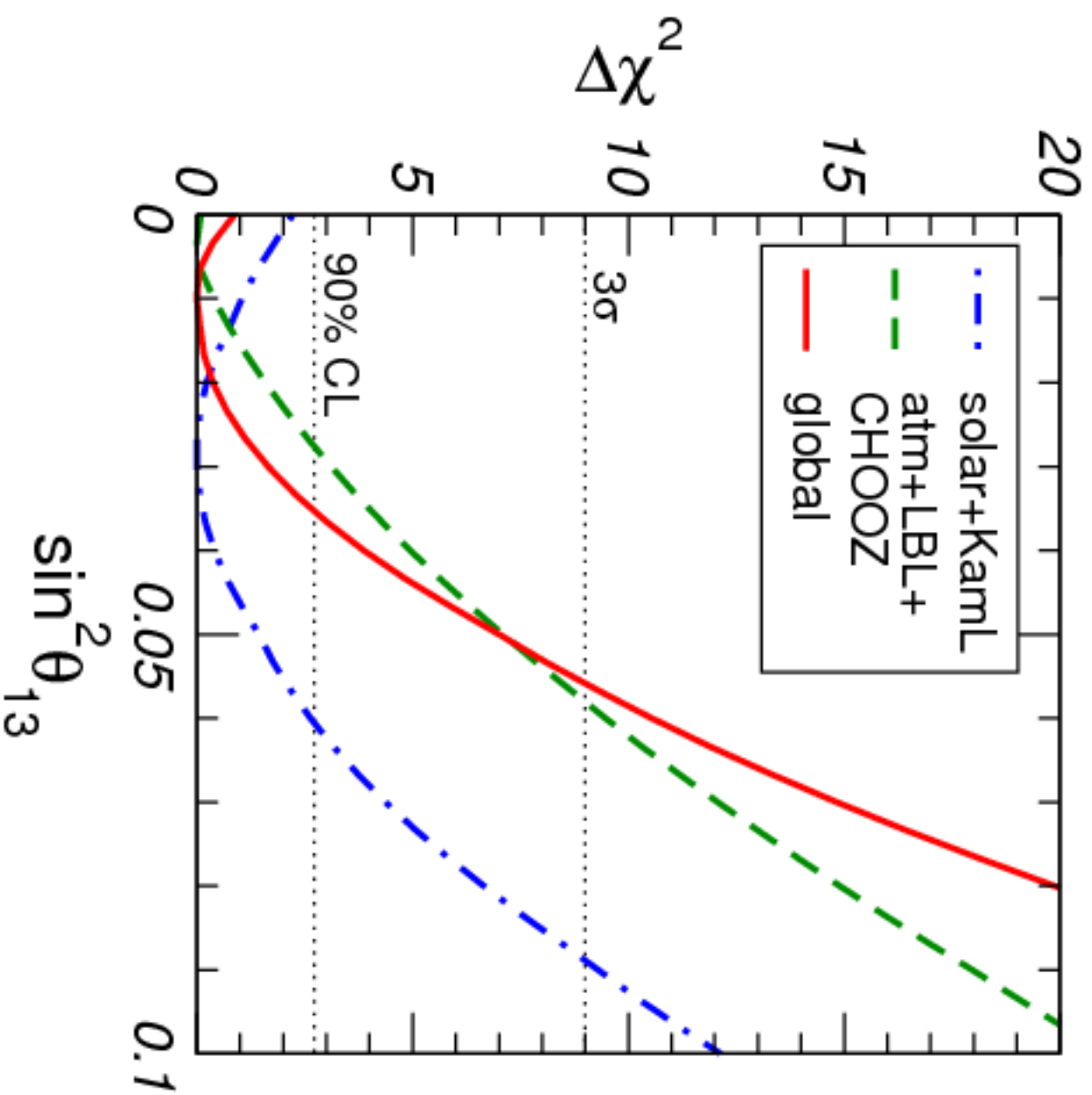

## Neutrino Oscillation Parameters

parameter	bf $\pm 1\sigma$	1 $\sigma$ acc.	2 $\sigma$ range	3 $\sigma$ range
$\Delta m_{21}^2$ [10 $^{-5}$ ]	7.65 $\pm$ 0.23	<b>3%</b>	7.25 – 8.11	7.05 – 8.34
$ \Delta m_{31}^2 $ [10 $^{-3}$ ]	2.4 $^{+0.12}_{-0.11}$	<b>5%</b>	2.18 – 2.64	2.07 – 2.75
$\sin^2 \theta_{12}$	0.304 $^{+0.022}_{-0.016}$	<b>7%</b>	0.27 – 0.35	0.25 – 0.37
$\sin^2 \theta_{23}$	0.50 $^{+0.07}_{-0.06}$	<b>14%</b>	0.38 – 0.64	0.36 – 0.67
$\sin^2 \theta_{13}$	0.016 $\pm$ 0.010	0.01 – 0.026	<b><math>\leq 0.04</math></b>	<b><math>\leq 0.056</math></b>

Best fit values (bf), 1 $\sigma$  errors, relative accuracies at 1 $\sigma$ , and 2 $\sigma$  and 3 $\sigma$  allowed ranges of three-flavor neutrino oscillation parameters from a combined analysis of global data.

M. Maltoni, T. Schwetz *et al.*, [arXiv:0812.3161](#); E. Lisi *et al.*, [arXiv:0806.2649](#) ( $\theta_{13}$ )

- $\text{sgn}(\Delta m_{\text{atm}}^2) = \text{sgn}(\Delta m_{31}^2)$  not determined

$$\Delta m_{\text{atm}}^2 \equiv \Delta m_{31}^2 > 0, \quad \text{normal mass ordering}$$

$$\Delta m_{\text{atm}}^2 \equiv \Delta m_{32}^2 < 0, \quad \text{inverted mass ordering}$$

Convention:  $m_1 < m_2 < m_3$  - **NMO**,  $m_3 < m_1 < m_2$  - **IMO**

$$m_1 \ll m_2 < m_3, \quad \text{NH,}$$

$$m_3 \ll m_1 < m_2, \quad \text{IH,}$$

$$m_1 \cong m_2 \cong m_3, \quad m_{1,2,3}^2 \gg \Delta m_{\text{atm}}^2, \quad \text{QD; } m_j \gtrsim 0.10 \text{ eV.}$$

- **Dirac phase  $\delta$ :**  $\nu_l \leftrightarrow \nu_{l'}, \bar{\nu}_l \leftrightarrow \bar{\nu}_{l'}, l \neq l'$ ;  $A_{\text{CP}}^{(ll')} \propto J_{\text{CP}} \propto \sin \theta_{13} \sin \delta$
- **Majorana phases  $\alpha_{21}, \alpha_{31}$ :**

- $\nu_l \leftrightarrow \nu_{l'}, \bar{\nu}_l \leftrightarrow \bar{\nu}_{l'}$  not sensitive;

S.M. Bilenky, J. Hosek, S.T.P., 1980;  
P. Langacker, S.T.P., G. Steigman, S. Toshev, 1987

- $|\langle m \rangle|$  in  $(\beta\beta)_{0\nu}$ -decay depends on  $\alpha_{21}, \alpha_{31}$ ;

- $\Gamma(\mu \rightarrow e + \gamma)$  etc. in SUSY theories depend on  $\alpha_{21,31}$ ;

- BAU, leptogenesis scenario:  $\alpha_{21,31}$  !

## The $(\text{Mass})^2$ Spectrum

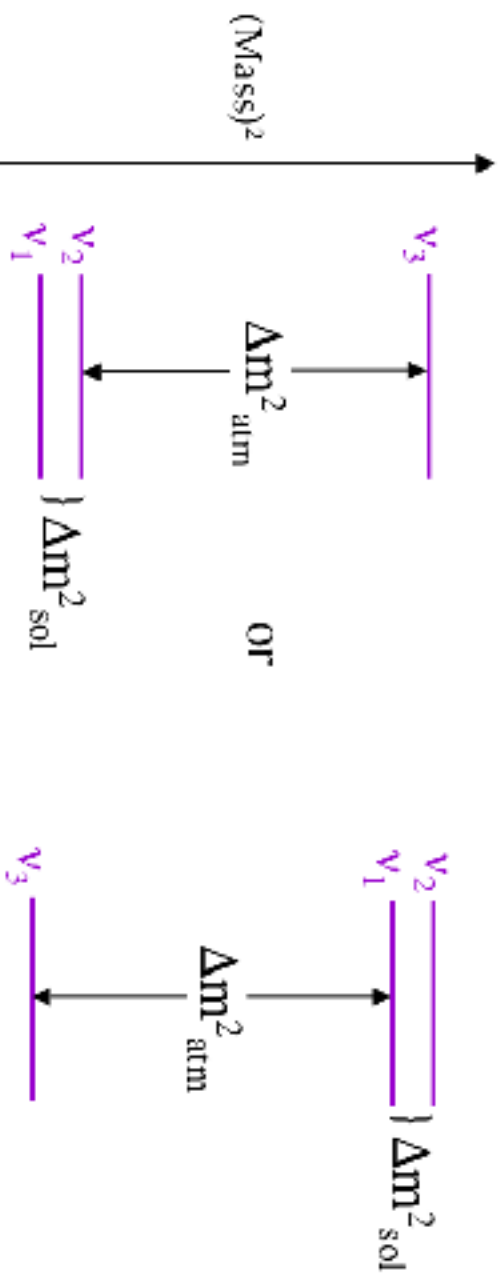

$$\Delta m^2_{\text{sol}} \cong 7.6 \times 10^{-5} \text{ eV}^2, \quad \Delta m^2_{\text{atm}} \cong 2.4 \times 10^{-3} \text{ eV}^2$$

Are there *more* mass eigenstates, as LSND suggests,  
and MiniBOONE recently hints?

3

# The Absolute Scale of Neutrino Mass

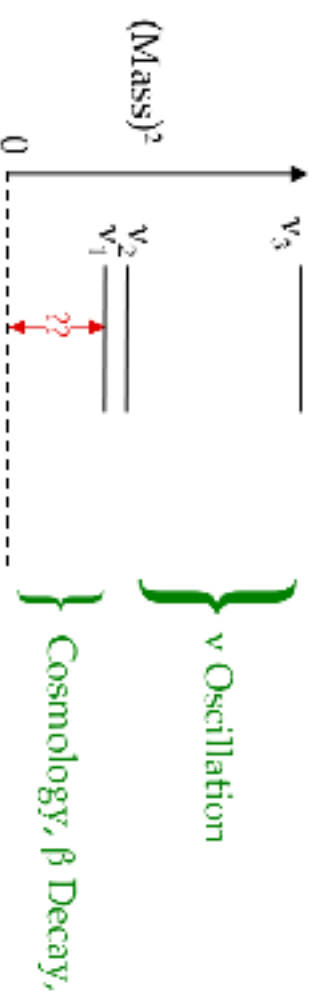

How far above zero  
is the whole pattern?

Oscillation Data  $\Rightarrow \sqrt{\Delta m_{\text{atm}}^2} < \text{Mass}[\text{Heaviest } \nu_i]$

4

## Future Progress

- Determination of the nature - Dirac or Majorana, of  $\nu_j$  .
- Determination of  $\text{sgn}(\Delta m_{\text{atm}}^2)$ , type of  $\nu$ - mass spectrum

$$m_1 \lll m_2 \lll m_3, \quad \text{NH,}$$

$$m_3 \lll m_1 < m_2, \quad \text{IH,}$$

$$m_1 \cong m_2 \cong m_3, \quad m_{1,2,3}^2 \gg \Delta m_{\text{atm}}^2, \quad \text{QD; } m_j \gtrsim 0.10 \text{ eV.}$$

- Determining, or obtaining significant constraints on, the absolute scale of  $\nu_j$ - masses, or  $\min(m_j)$ .
- Status of the CP-symmetry in the lepton sector: violated due to  $\delta$  (Dirac), and/or due to  $\alpha_{21}$ ,  $\alpha_{31}$  (Majorana)?
- High precision determination of  $\Delta m_{\odot}^2$ ,  $\theta_{\odot}$ ,  $\Delta m_{\text{atm}}^2$ ,  $\theta_{\text{atm}}$ .
- Measurement of, or improving by at least a factor of (5 - 10) the existing upper limit on,  $\sin^2 \theta_{13}$ .
- Searching for possible manifestations, other than  $\nu_l$ -oscillations, of the non-conservation of  $L_l$ ,  $l = e, \mu, \tau$ , such as  $\mu \rightarrow e + \gamma$ ,  $\tau \rightarrow \mu + \gamma$ , etc. decays.

- Understanding at fundamental level the mechanism giving rise to the  $\nu$ - masses and mixing and to the  $L_I$ -non-conservation. Includes understanding
  - the origin of the observed patterns of  $\nu$ -mixing and  $\nu$ -masses ;
  - the physical origin of  $CPV$  phases in  $U_{PMNS}$  ;
  - Are the observed patterns of  $\nu$ -mixing and of  $\Delta m_{21,31}^2$  related to the existence of a new symmetry?
  - Is there any relations between  $q$ -mixing and  $\nu$ - mixing? Is  $\theta_{12} + \theta_e \equiv \pi/4$  ?
  - Is  $\theta_{23} = \pi/4$ , or  $\theta_{23} > \pi/4$  or else  $\theta_{23} < \pi/4$ ?
  - Is there any correlation between the values of  $CPV$  phases and of mixing angles in  $U_{PMNS}$ ?
- Progress in the theory of  $\nu$ -mixing might lead to a better understanding of the origin of the BAU.
  - Can the Majorana and/or Dirac  $CPVP$  in  $U_{PMNS}$  be the leptogenesis  $CPV$  parameters at the origin of BAU?



## HOW?

- $\nu_{\odot} \rightarrow \nu_{\text{atm}}$  experiments

SK ( $\nu_{\text{atm}}$ );

INO ( $\nu_{\text{atm}}$ ); MEMPHYS

MINOS ( $\nu_{\mu}^{\text{atm}}$ ); ATLAS, CMS ( $\nu_{\mu}^{\text{atm}}$ ) (?)

SNO (2006)

SAGE

BOREXINO

LowNu (XMASS, LENS,...)

- **Reactor Experiments**  $\sim (1 - 180)$  km (SKGd)

- **Accelerator Experiments**

MINOS      732 km

CNGS (OPERA)      732 km

- Super Beams

T2K, SK (HK)      295 km

NO $\nu$ A              ~800 km

LBNE (Fermilab-DUSEL)      ~1200 km

SPL+ $\beta$ -beams, MEMPHYS (0.5 megaton):

CERN-Frejus      ~140 km

$\nu$ -Factories      ~ 3000, 7000 km

- $(\beta\beta)_{0\nu}$ -Decay,  ${}^3\text{H}$   $\beta$ -Decay

- Astrophysics, Cosmology



(c) 2000 ESHI

## T2K: First results March 2011

Observed 1  $e^-$ -event passing all cuts and having all the characteristics of being due to  $\nu_\mu \rightarrow \nu_e$  oscillations. The estimated background is:  $0.30 \pm 0.07$ (syst.) events; 29% probability to observe 1 event when the expected average is 0.3 events.

NH:  $\sin^2 2\theta_{13} < 0.44$ ; IH:  $\sin^2 2\theta_{13} < 0.53$  (90% C.L.)

Assumed:  $|\Delta m_{23}^2| = 2.4 \times 10^{-3} \text{ eV}^2$ ,  $\sin^2 2\theta_{23} = 1$ ,  $\delta = 0$ .

T2K: Latest results June 14, 2011 ( $1.43 \times 10^{20}$  pot, full data analysis)

Observed 6  $e^-$ -events passing all criteria for being due to  $\nu_\mu \rightarrow \nu_e$  oscillations. The estimated background ( $\theta_{13} = 0$ ):  $1.5 \pm 0.03$ (syst.) events; the probability to observe  $\geq 6$  events given 1.5 are expected:  $7 \times 10^{-3}$ .

Evidence for  $\theta_{13} \neq 0$  at  $2.5\sigma$ .

For  $|\Delta m_{23}^2| = 2.4 \times 10^{-3} \text{ eV}^2$ ,  $\sin^2 2\theta_{23} = 1$ ,  $\delta = 0$ , NO (IO) spectrum:

$(2 \sin^2 \theta_{23}) \sin^2 2\theta_{13} = 0.11$  (0.14), best fit;

$0.03(0.04) < (2 \sin^2 \theta_{23}) \sin^2 2\theta_{13} < 0.28(0.34)$ , 90% C.L.

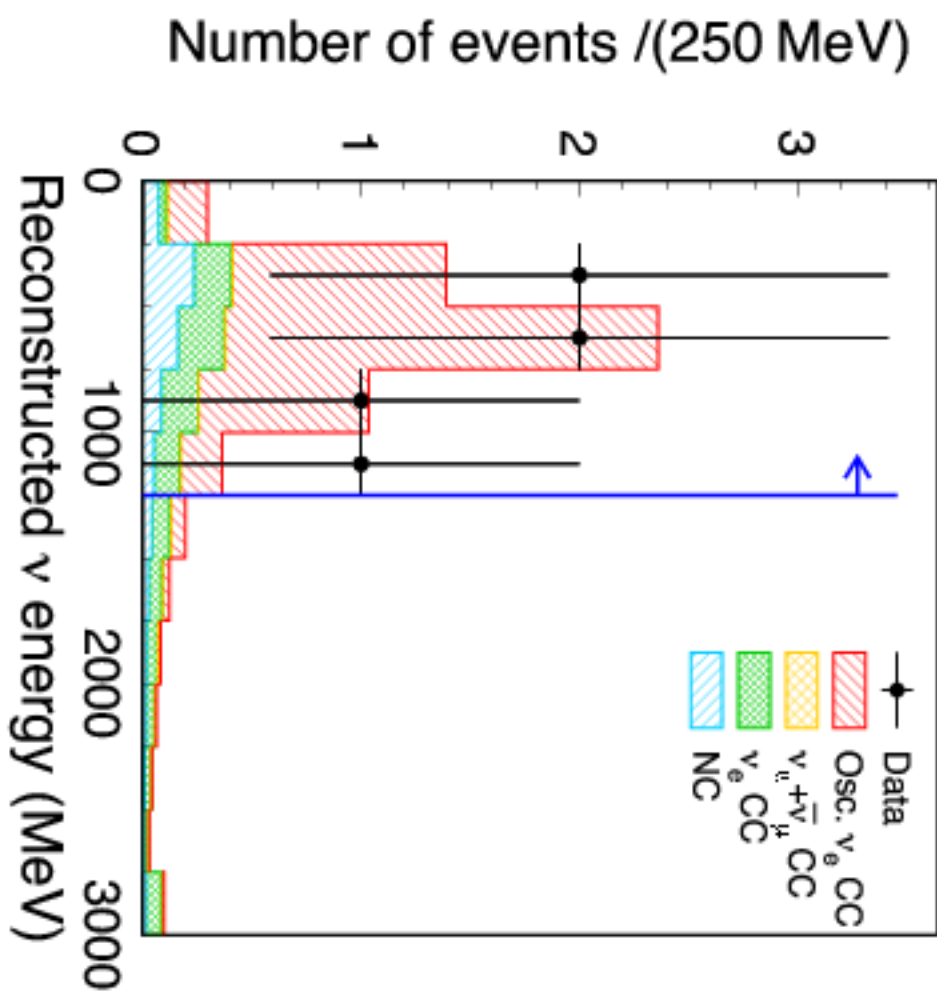

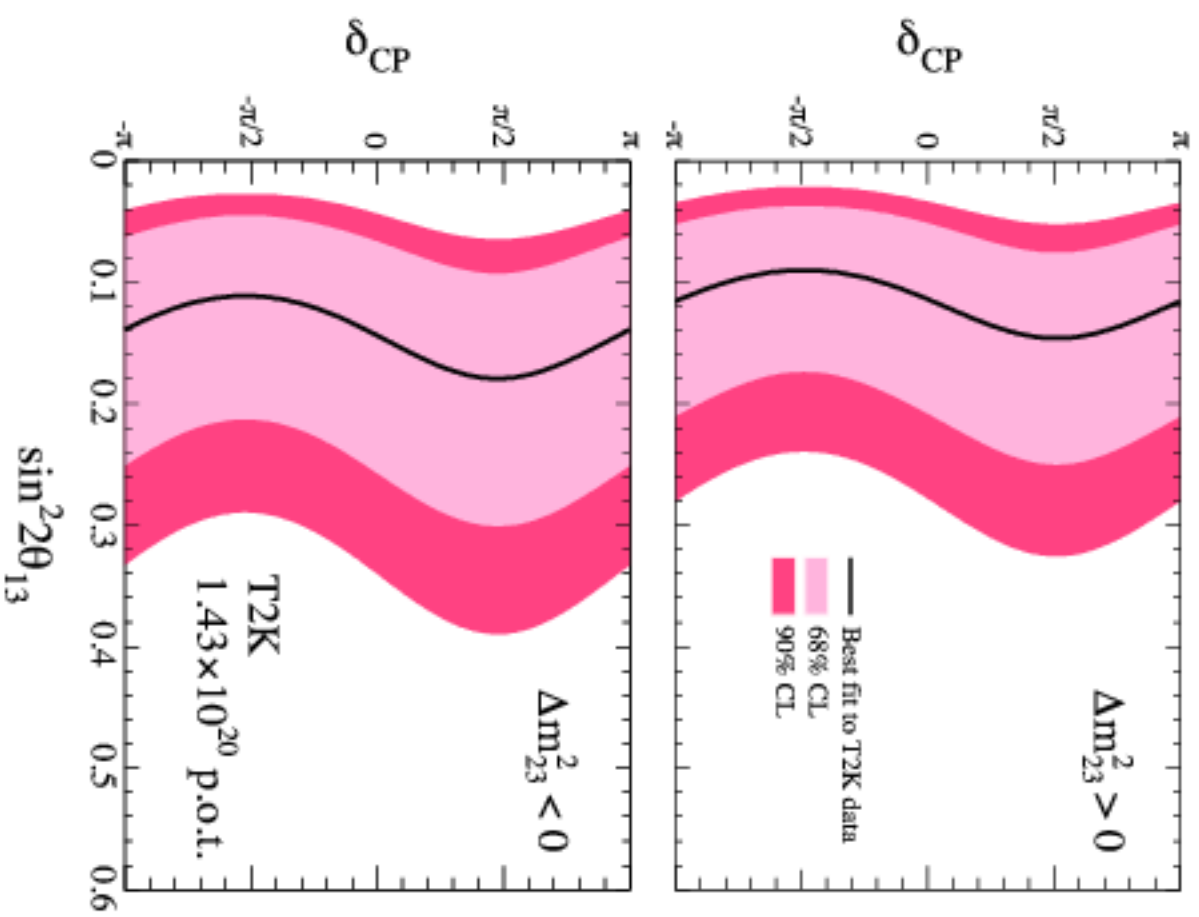

Japan experienced very severe earthquake on March 11th 2011 at 14:46 JST. The J-PARC facility suffered some damages. Fortunately, the Tsunami did not hit the J-PARC.

“Our present priority is to restore life-supporting infrastructure such as electricity, water supply and gas at J-PARC. It may take some time, but we promise the full recovery of the J-PARC accelerator and T2K experiment in the near future. I thank you for the messages of solidarity and sympathy”.

Director of the Institute of Particle and Nuclear Studies, KEK

Koichiro Nishikawa

Spokesperson of the T2K experiment

Takashi Kobayashi

**We wish success to our colleagues from T2K, J-PARC and KEK in their reconstruction efforts.**

MINOS: Latest results June 24, 2011 ( $8.2 \times 10^{20}$  pot, **prelim.**)  
**Observed 62  $e^-$ -events passing all criteria for being due to  $\nu_\mu \rightarrow \nu_e$  oscillations. Estimated background:  $49.5 \pm 2.8 \pm 7.0$ (stat.) events.**

**1.7 $\sigma$  excess above background.**

**For  $|\Delta m_{23}^2| = 2.4 \times 10^{-3} \text{ eV}^2$ ,  $\sin^2 2\theta_{23} = 1$ ,  $\delta = 0$ , **NO (IO) spectrum:****

**$(2 \sin^2 \theta_{23}) \sin^2 2\theta_{13} = 0.04$  (0.08), best fit;**

**$0 \leq (2 \sin^2 \theta_{23}) \sin^2 2\theta_{13} \leq 0.12$  (0.19), 90% C.L.**



Results on  
appearance of  
electron-neutrinos  
with  $8.2 \times 10^{20}$  POT

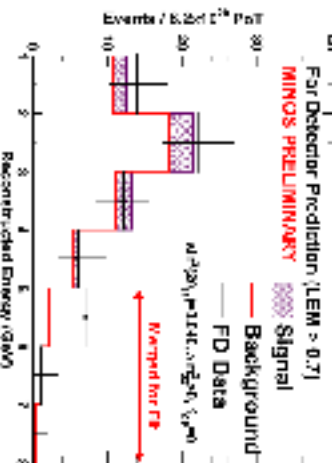

The reconstructed energy spectrum of  $\nu_e$ -like candidate events  
 Made with  $\nu_e$  are overlaid using mono-energetic  $\nu_e$  flux



Results on  
appearance of  
electron-neutrinos  
with  $8.2 \times 10^{20}$  POT

For  $\delta_{\nu\tau} = 0$  if allowed values of  
 $2 \sin^2(\theta_{12}) \sin^2(\theta_{13})$  at 90% C.L. are:  
 0 to 0.12 (central) central value: 0.04  
 0 to 0.19 (inverted) central value: 0.08

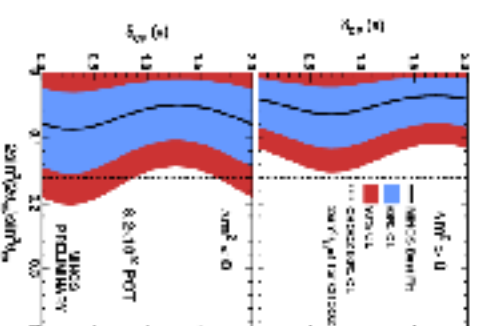

backgrounds based on the identity,  
 similar to that of neutrinos.



G.L. Fogli *et al.*, June 29, 2011: global data analysis.

Evidence for  $\theta_{13} \neq 0$  at  $\geq 3\sigma$ .

$\sin^2 \theta_{13} = 0.021 (0.025) \pm 0.007$ , old (new) reactor fluxes;  
 $0.001(0.005) < \sin^2 \theta_{13} < 0.044(0.050)$ ,  $3\sigma$ .

Global data:  $\cos \delta = -1$  clearly favored over  $\cos \delta = +1$ ;

best fit:  $\sin \theta_{13} \cos \delta = -0.14$ .

### Synopsis of global $3\nu$ oscillation analysis

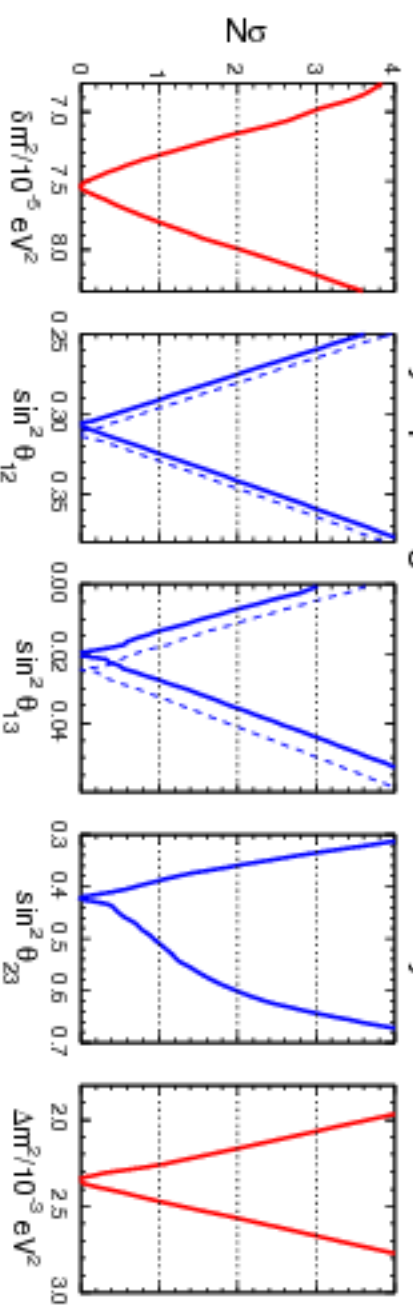

### Global evidence for $\theta_{13} > 0$

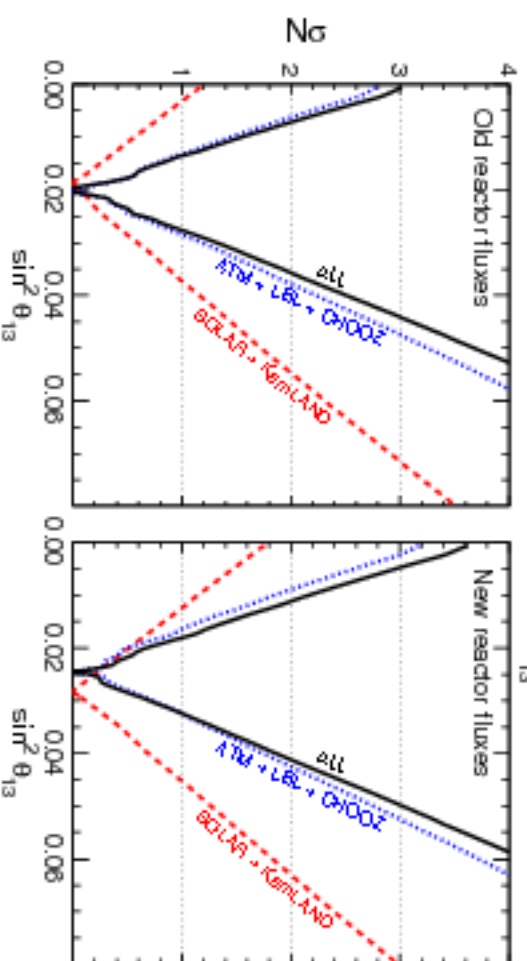

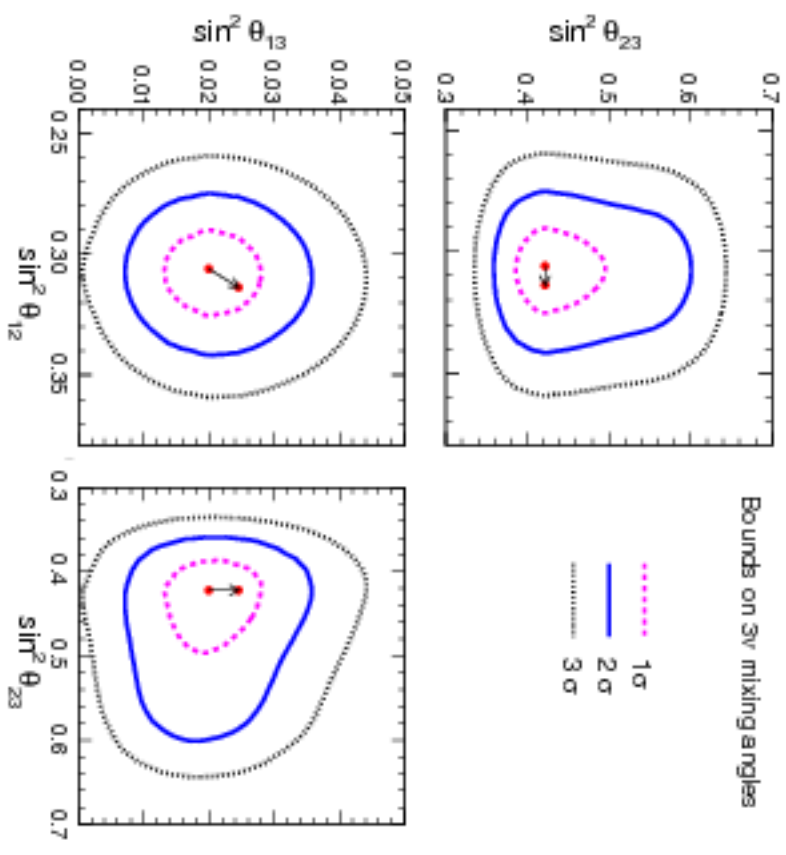

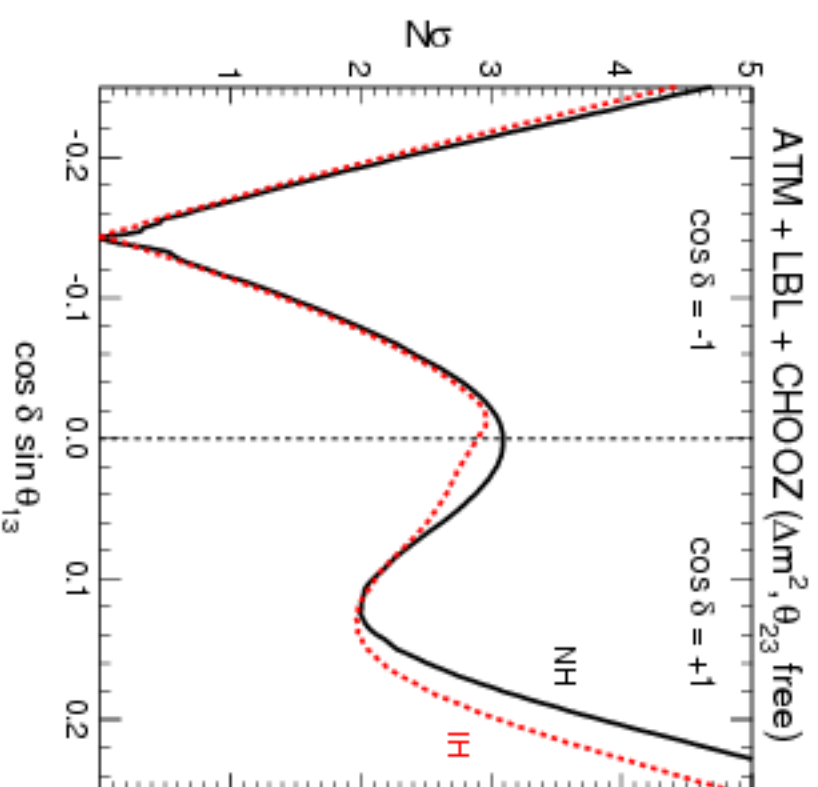

Global data:  $\cos \delta = -1$  clearly favored over  $\cos \delta = +1$ ;

best fit:  $\sin \theta_{13} \cos \delta = -0.14$ .

## Neutrino oscillation parameters summary.

Results of the global  $3\nu$  oscillation analysis, in terms of best-fit values and allowed  $1$ ,  $2$  and  $3\sigma$  ranges for the mass-mixing parameters, assuming old reactor neutrino fluxes. By using new reactor fluxes, the corresponding best fits and ranges for  $\sin^2\theta_{12}$  and  $\sin^2\theta_{13}$  (in parentheses) are basically shifted by about  $\pm 0.006$  and  $\pm 0.004$ , respectively, while the other parameters are essentially unchanged.

---

Parameter	$\delta m^2/10^{-5}$ eV <sup>2</sup>	$\sin^2\theta_{12}$	$\sin^2\theta_{13}$	$\sin^2\theta_{23}$	$\Delta m^2/10^{-3}$ eV <sup>2</sup>
Best fit	7.58	0.306 (0.312)	0.021 (0.025)	0.42	2.35
$1\sigma$ range	7.32 – 7.80	0.291 – 0.324 (0.296 – 0.329)	0.013 – 0.028 (0.018 – 0.032)	0.39 – 0.50	2.26 – 2.47
$2\sigma$ range	7.16 – 7.99	0.275 – 0.342 (0.280 – 0.347)	0.008 – 0.036 (0.012 – 0.041)	0.36 – 0.60	2.17 – 2.57
$3\sigma$ range	6.99 – 8.18	0.259 – 0.359 (0.265 – 0.364)	0.001 – 0.044 (0.005 – 0.050)	0.34 – 0.64	2.06 – 2.67

Large  $\sin^2 \theta_{13} \cong 0.021$  - far-reaching implications for the program of research in neutrino physics:

- For the searches for CP violation in  $\nu$ -oscillations;
- For the determination of the type of  $\nu$ -mass spectrum (or of  $\text{sgn}(\Delta m_{atm}^2)$ ) in neutrino oscillation experiments.
- For understanding the pattern of the neutrino mixing and its origins (symmetry, etc.?).
- For the observation of the Earth mantle-core enhancement (Neutrino Oscillation Length Resonance) in the  $\nu_{e(\mu)} \rightarrow \nu_{\mu(e)}$  (or  $\bar{\nu}_{e(\mu)} \rightarrow \bar{\nu}_{\mu(e)}$ ) oscillations of the atmospheric neutrinos crossing the Earth core.
- For the predictions for the  $(\beta\beta)_{0\nu}$ -decay effective Majorana mass in the case of NH light  $\nu$  mass spectrum (possibility of a strong suppression).
- Important implications also for the “flavoured” leptogenesis scenario of generation of the baryon asymmetry of the Universe.

## Prospects for $\theta_{13}$

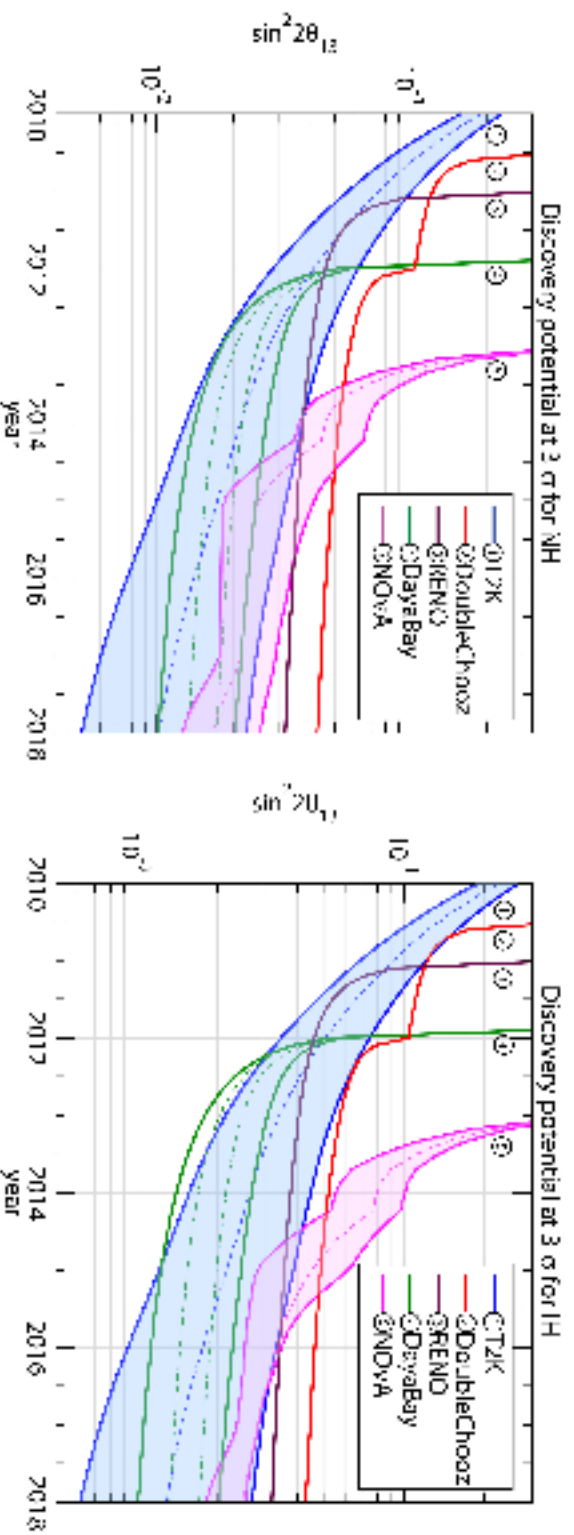

Width: experiments with  $\nu$  beams - dependence on the CP phase; DayaBay - syst. uncert. 0.18% – 0.6%

Mezzetto, Schwetz, 1003.5800

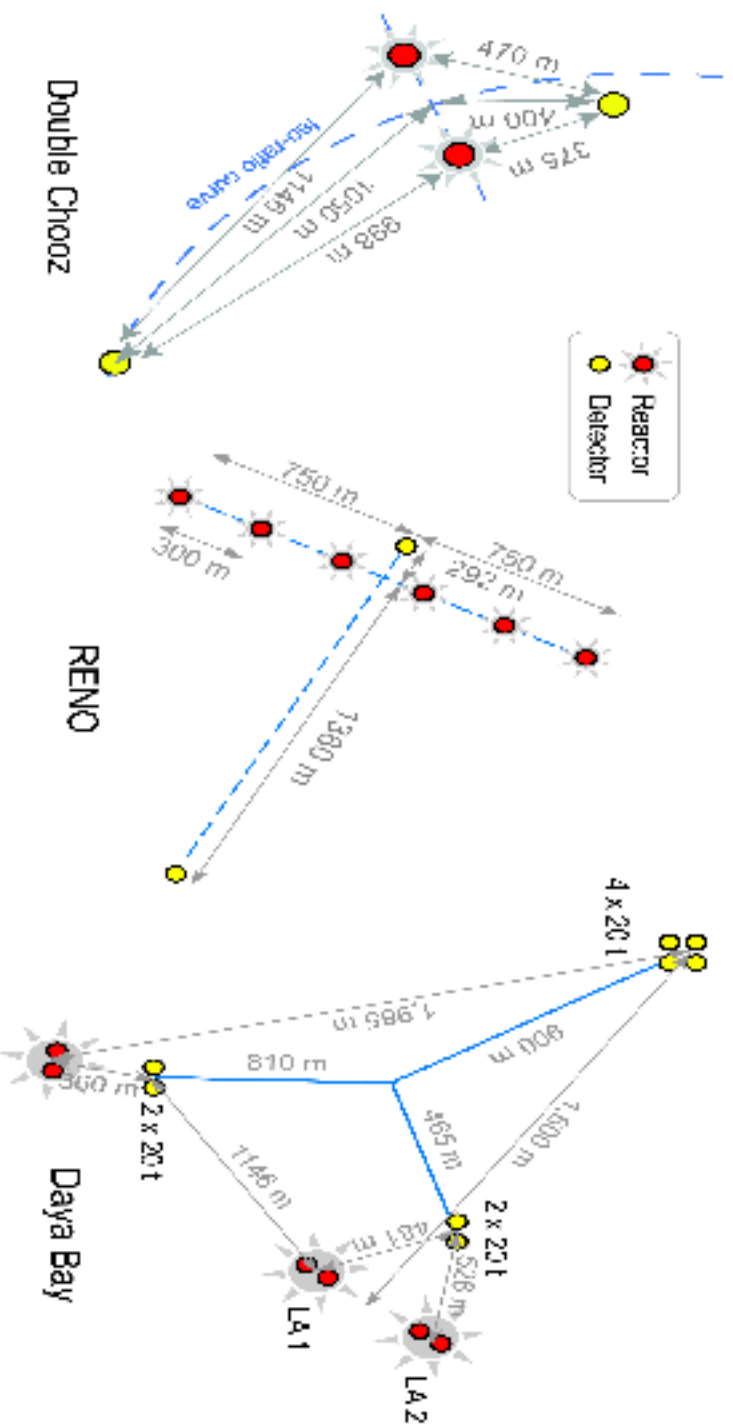

M. Mezzetto, T. Schwetz, arXiv:1003.5800[hep-ph]



The 3-neutrino mixing - still the reference framework.

3- $\nu$  oscillation parameters summary.

parameter	best fit $\pm 1\sigma$	$2\sigma$	$3\sigma$
$\Delta m_{21}^2$ [ $10^{-5} \text{eV}^2$ ]	$7.58^{+0.22}_{-0.26}$	$7.16 - 7.99$	$6.99 - 8.18$
$ \Delta m_{31}^2 $ [ $10^{-3} \text{eV}^2$ ]	$2.35^{+0.12}_{-0.09}$	$2.26 - 2.47$	$2.06 - 2.67$
$\sin^2 \theta_{12}$	$0.306^{+0.018}_{-0.015}$	$0.275 - 0.342$	$0.259 - 0.359$
$\sin^2 \theta_{23}$	$0.42^{+0.08}_{-0.03}$	$0.36 - 0.60$	$0.34 - 0.64$
$\sin^2 \theta_{13}$	$0.021^{+0.007}_{-0.008}$ ( $0.025^{+0.007}_{-0.007}$ )	$0.08 - 0.036$ ( $0.012 - 0.041$ )	$0.001 - 0.044$ ( $0.005 - 0.050$ )

Fogli, Lisi, Marrone, Palazzo, Rotunno, arXiv:1106.6028

$\sin^2 \theta_{13}$ : upper (lower) row - old (new) reactor fluxes.

## Neutrino Mixing:

- $\theta_{12} = \theta_{\odot} \cong \frac{\pi}{5.4}$ ,

$$\theta_{23} = \theta_{\text{atm}} \cong \frac{\pi}{4},$$

$$\theta_{13} < \frac{\pi}{13}$$

$$U_{\text{PMNS}} \cong \begin{pmatrix} \sqrt{\frac{2}{3}} & \sqrt{\frac{1}{3}} & \epsilon \\ -\sqrt{\frac{1}{6}} & \sqrt{\frac{1}{3}} & -\sqrt{\frac{1}{2}} \\ -\sqrt{\frac{1}{6}} & \sqrt{\frac{1}{3}} & \sqrt{\frac{1}{2}} \end{pmatrix};$$

## Very different from the CKM-matrix!

- $\cos \theta_{12} \cong \cos(\frac{\pi}{4} - \frac{\pi}{12}) = \frac{1}{\sqrt{2}}(1 + \lambda)$ ,  $\sin \theta_{12} \cong \frac{1}{\sqrt{2}}(1 - \lambda)$ ,
- $\lambda \cong (0.20 - 0.25)$ :  $\theta_{\odot} + \theta_c = (47 \pm 1.2)^{\text{deg}} = \pi/4$  ?
- $U_{\text{PMNS}}$  due to new approximate symmetry?

## A Natural Possibility:

$$U = U_{\text{lep}}^{\dagger}(\lambda) U_{\text{bim}(\text{tri})} P(\alpha_{21}, \alpha_{31}),$$

with

$$U_{\text{tri}} = \begin{pmatrix} \frac{\sqrt{2}}{3} & \frac{\sqrt{1}}{3} & 0 \\ -\frac{\sqrt{1}}{6} & \frac{\sqrt{1}}{3} & -\frac{\sqrt{1}}{2} \\ -\frac{\sqrt{1}}{6} & \frac{\sqrt{1}}{3} & \frac{\sqrt{1}}{2} \end{pmatrix}; \quad U_{\text{bim}} = \begin{pmatrix} \frac{1}{\sqrt{2}} & \pm \frac{1}{\sqrt{2}} & 0 \\ -\frac{1}{2} & \pm \frac{1}{2} & \frac{1}{\sqrt{2}} \\ \frac{1}{2} & \mp \frac{1}{2} & \frac{1}{\sqrt{2}} \end{pmatrix}.$$

- $U_{\text{lep}}^{\dagger}(\lambda)$  - from diagonalization of the  $l^-$  mass matrix,
- $U_{\text{bim}(\text{tri})} P$  - from diagonalization of the  $\nu$ -mass matrix.
- $U_{(\text{tri})}$ :  $s_{12}^2 = 1/3$ ,  $s_{23}^2 = 1/2$ ,  $s_{13}^2 = 0$ , in agreement with the current data.

Harrison, Perkins, Scott, 2002

$U_{(\text{tri})}$ : Groups  $A_4, S_4, \dots$  (vast literature)

(Reviews: Altarelli, Feruglio, 1002.0211, Tanimoto et al., 1003.3552)

Typically,  $\theta_{13} \sim (\lambda_c)^2$  is predicted.

- $U_{\text{bim}}$ :  $s_{12}^2 = 1/2$ ,  $s_{23}^2 = 1/2$ ,  $s_{13}^2 = 0$ ;  $s_{12}^2 = 1/2$  must be corrected.

$U_{\text{bim}}$ : Groups  $S_4, \dots$ ; typically  $\theta_{13} \sim \lambda_c$ .

- $U_{\text{bim}}$ : alternatively  $U(1)$ ,

$$L = L_e - L_\mu - L_\tau \quad (\Delta m_\odot^2 \ll |\Delta m_{\text{atm}}^2|)$$

S.T.P., 1982

$U_{\text{bim(tri)}}$  requires a  $\mu - \tau$  symmetry of  $M_\nu$

- Additional possibility:  $\sin^2 \theta_{12} = \frac{2}{5+\sqrt{5}} \cong 0.28$ , “Golden ratio”;  $A_5$ .

Kajiyama et al., 2007; Everett, Stuart, 2008, 2011

$$U_{\text{GR}} = \begin{pmatrix} \cos \theta_{12} & \sin \theta_{12} & 0 \\ -\frac{\sin \theta_{12}}{2} & \frac{\cos \theta_{12}}{2} & \frac{1}{\sqrt{2}} \\ -\frac{\sin \theta_{12}}{2} & \frac{\cos \theta_{12}}{2} & -\frac{1}{\sqrt{2}} \end{pmatrix}.$$

Feruglio, 2011

Which is the correct approximate form of  $U_{\text{PMNS}}$ ? Perhaps none of the above(?).

For  $\sin^\ell \theta_{ij} \equiv \lambda_{ij}$  “small”,  $\lambda_{12} \gg \lambda_{13}$  (natural),

$$\sin^2 \theta_{12} = \frac{1}{2} - \sin 2\theta'_{12} \sin \theta_{13} \cos \delta, \quad U_{\text{bim}},$$

$\delta$  is the Dirac CPV phase;

$U_{\text{bim}}$ :  $\sin 2\theta'_{12} = \pm 1$ , **only**  $\sin 2\theta'_{12} = -1$  **is possible**  
if  $\sin \theta_{13} \cos \delta < 0$ .

$$\sin^2 \theta_{12} = \frac{1}{3} \mp 2 \frac{\sqrt{2}}{3} \sin \theta_{13} \cos \delta, \quad U_{\text{tri}}.$$

P. Frampton, S.T.P., W. Rodejohann, 2004;

S. King, 2005; S. Antusch, S. King, 2005; I. Masina, 2006;

K. Hochmuth, S.T.P., W. Rodejohann, 2007

Can be tested experimentally.

## Rephasing Invariants Associated with CPVP

Dirac phase  $\delta$ :

$$J_{CP} = \text{Im} \{ U_{e1} U_{\mu 2} U_{e2}^* U_{\mu 1}^* \} .$$

C. Jarlskog, 1985 (for quarks)

CP-, T- violation effects in neutrino oscillations

P. Krastev, S.T.P., 1988

Majorana phases  $\alpha_{21}$ ,  $\alpha_{31}$ :

$$S_1 = \text{Im} \{ U_{e1} U_{e3}^* \}, \quad S_2 = \text{Im} \{ U_{e2} U_{e3}^* \} \quad (\text{not unique}); \quad \text{or}$$
$$S'_1 = \text{Im} \{ U_{\tau 1} U_{\tau 2}^* \}, \quad S'_2 = \text{Im} \{ U_{\tau 2} U_{\tau 3}^* \}$$

J.F. Nieves and P. Pal, 1987, 2001

G.C. Branco et al., 1986

J.A. Aguilar-Saavedra and G.C. Branco, 2000

**CP-violation:** both  $\text{Im} \{ U_{e1} U_{e3}^* \} \neq 0$  and  $\text{Re} \{ U_{e1} U_{e3}^* \} \neq 0$  .

$S_1, S_2$  appear in  $|\langle m \rangle|$  in  $(\beta\beta)_{\nu\nu}$ -decay.

In general,  $J_{CP}$ ,  $S_1$  and  $S_2$  are independent.

# Dirac CP-Nonconservation: $\delta$ in $U_{\text{PMNS}}$

Observable manifestations in

$$\nu_l \leftrightarrow \nu_{l'}, \quad \bar{\nu}_l \leftrightarrow \bar{\nu}_{l'}, \quad l, l' = e, \mu, \tau$$

- not sensitive to Majorana CPVP  $\alpha_{21}$ ,  $\alpha_{31}$

CP-Invariance:

N. Cabibbo, 1978  
S.M. Bilenky, J. Hosek, S.T.P., 1980;  
V. Barger et al., 1980.

CP-T-invariance:  
 $P(\nu_l \rightarrow \nu_{l'}) = P(\bar{\nu}_l \rightarrow \bar{\nu}_{l'})$ ,  $l \neq l' = e, \mu, \tau$

$$P(\nu_l \rightarrow \nu_{l'}) = P(\bar{\nu}_{l'} \rightarrow \bar{\nu}_l)$$

$$l = l': \quad P(\nu_l \rightarrow \nu_l) = P(\bar{\nu}_l \rightarrow \bar{\nu}_l)$$

T-Invariance:

$$P(\nu_l \rightarrow \nu_{l'}) = P(\nu_{l'} \rightarrow \nu_l), \quad l \neq l'$$

3 $\nu$ —mixing:

$$A_{\text{CP}}^{(ll')} \equiv P(\nu_l \rightarrow \nu_{l'}) - P(\bar{\nu}_l \rightarrow \bar{\nu}_{l'}), \quad l \neq l' = e, \mu, \tau$$

$$A_{\tau}^{(ll')} \equiv P(\nu_l \rightarrow \nu_{l'}) - P(\nu_{l'} \rightarrow \nu_l), \quad l \neq l'$$

$$A_{\tau}^{(e,\mu)} = A_{\tau}^{(\mu,\tau)} = -A_{\tau}^{(e,\tau)}$$

In vacuum:

$$A_{\text{CP}(\tau)}^{(e,\mu)} = J_{\text{CP}} F_{\text{osc}}^{\text{vac}}$$

$$J_{\text{CP}} = \text{Im} \{ U_{e1} U_{\mu 2} U_{e2}^* U_{\mu 1}^* \} = \frac{1}{8} \sin 2\theta_{12} \sin 2\theta_{23} \sin 2\theta_{13} \cos \theta_{13} \sin \delta$$

$$F_{\text{osc}}^{\text{vac}} = \sin\left(\frac{\Delta m_{21}^2}{2E} L\right) + \sin\left(\frac{\Delta m_{32}^2}{2E} L\right) + \sin\left(\frac{\Delta m_{13}^2}{2E} L\right)$$

P.I. Krastev, S.T.P., 1988

In matter: Matter effects violate

$$\text{CP} : P(\nu_l \rightarrow \nu_l) \neq P(\bar{\nu}_l \rightarrow \bar{\nu}_l)$$

$$\text{CPT} : P(\nu_l \rightarrow \nu_l) \neq P(\bar{\nu}_l \rightarrow \bar{\nu}_l)$$

P. Langacker et al., 1987

Can conserve the T-invariance (**Earth**)

$$P(\nu_l \rightarrow \nu_l) = P(\nu_l \rightarrow \nu_l), l \neq l'$$

In matter with constant density:  $A_{\tau}^{(e,\mu)} = J_{\text{CP}}^{\text{mat}} F_{\text{osc}}^{\text{mat}}$

$$J_{\text{CP}}^{\text{mat}} = J_{\text{CP}}^{\text{vac}} R_{\text{CP}}$$

$R_{\text{CP}}$  does not depend on  $\theta_{23}$  and  $\delta$ ;  $|R_{\text{CP}}| \lesssim 2.5$

P.I. Krastev, S.T.P., 1988



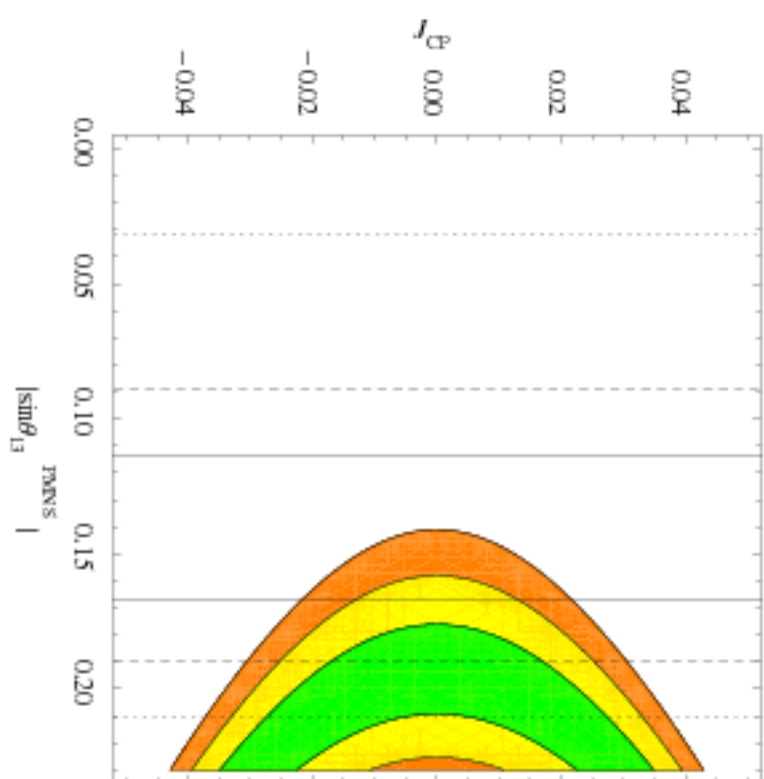
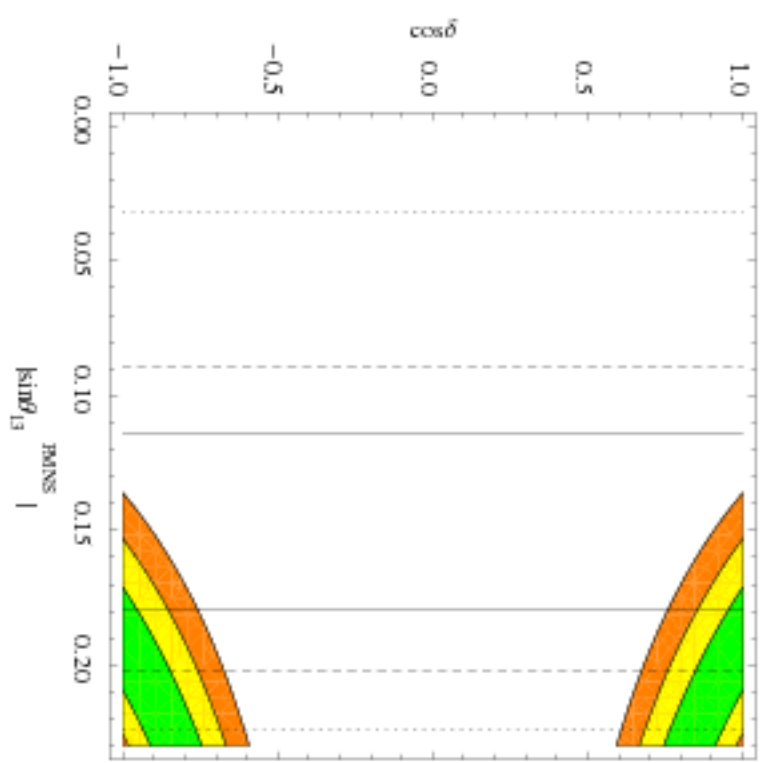

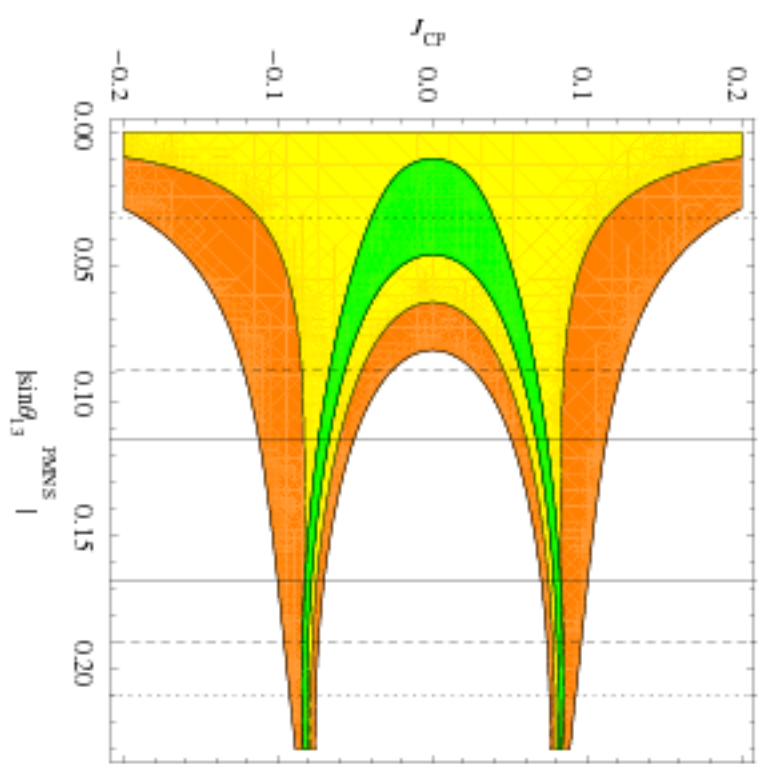
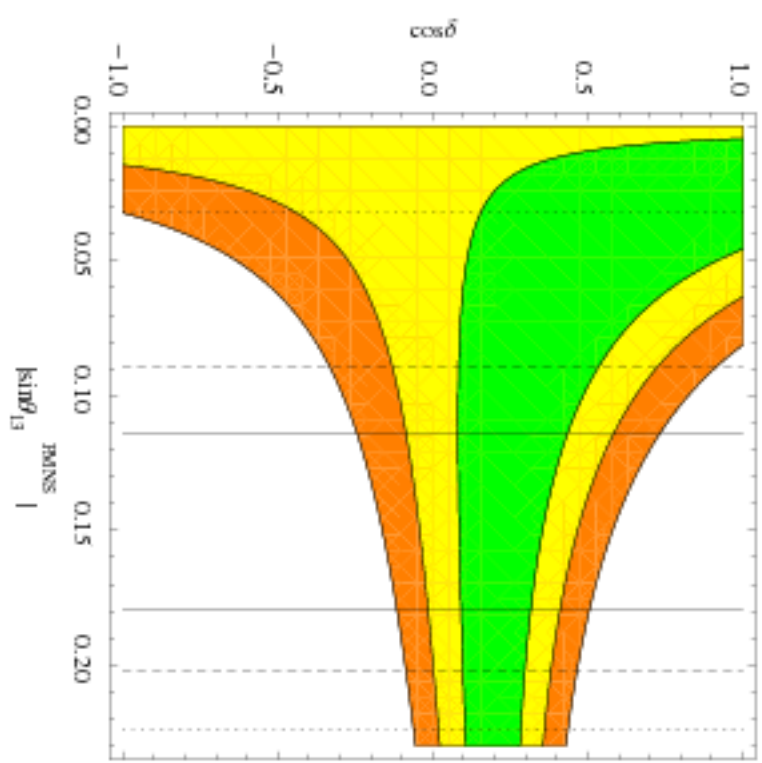

Up to 2nd order in the two small parameters  $|\alpha| \equiv |\Delta m_{21}^2|/|\Delta m_{31}^2| \ll 1$  and  $\sin^2 \theta_{13} \ll 1$ :

$$P_m^{3\nu \text{ man}}(\nu_e \rightarrow \nu_\mu) \cong P_0 + P_{\sin \delta} + P_{\cos \delta} + P_3,$$

$$P_0 = \sin^2 \theta_{23} \frac{\sin^2 2\theta_{13}}{(A-1)^2} \sin^2[(A-1)\Delta],$$

$$P_3 = \alpha^2 \cos^2 \theta_{23} \frac{\sin^2 2\theta_{12}}{A^2} \sin^2(A\Delta),$$

$$P_{\sin \delta} = \alpha \frac{8J_{CP}}{A(1-A)} (\sin \Delta) (\sin A\Delta) (\sin[(1-A)\Delta]),$$

$$P_{\cos \delta} = \alpha \frac{8J_{CP} \cot \delta}{A(1-A)} (\cos \Delta) (\sin A\Delta) (\sin[(1-A)\Delta]),$$

$$\Delta = \frac{\Delta m_{31}^2 L}{4E}, \quad A = \sqrt{2} G_F N_e^{man} \frac{2E}{\Delta m_{31}^2}.$$

$$\bar{\nu}_e \rightarrow \bar{\nu}_\mu: \delta, A \rightarrow (-\delta), (-A)$$

For  $L = 1200$  km ( $\sim$  Fermilab to DUSEL),  
and  $\sin^2 2\theta_{13} = 0.04$

(Parke)

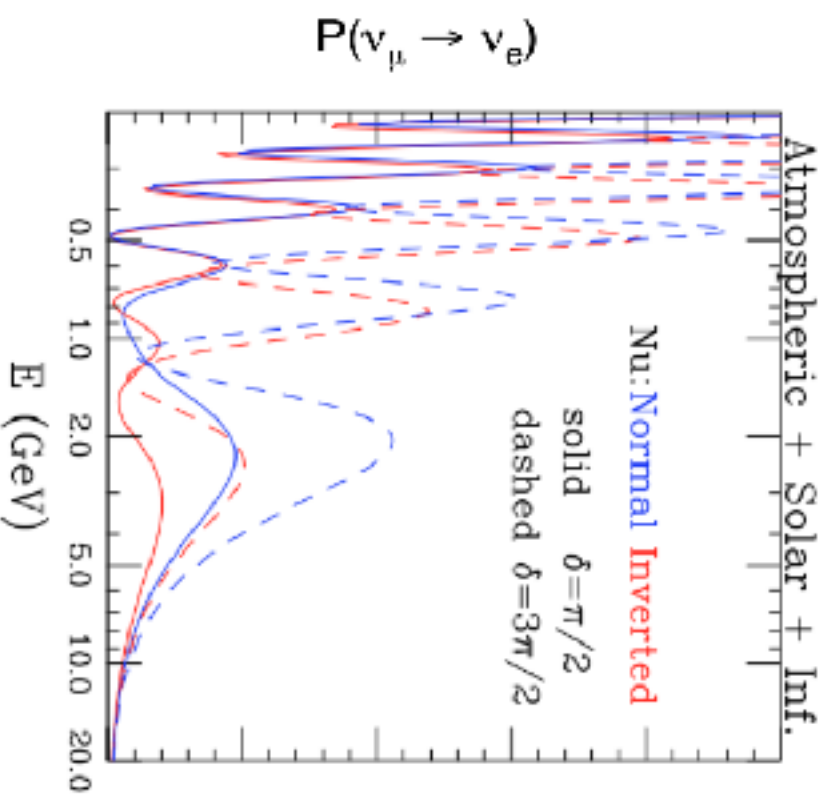

*Note how the  
2<sup>nd</sup> maximum  
can help.*

## HOW?

- Reactor Experiments at  $L \sim 1$  km: D-CHOOZ, Daya Bay, RENO (start: 2010; 2012; 2011)
- MINOS, CNGS (OPERA),  $L \sim 730$  km:  
 $\sin^2 \theta_{13}$

- Super Beams:  $\theta_{13}, \delta, \dots$

JHF (T2K), SK (HK)      295 km (started)

NUMI (NO $\nu$ A)               $\sim 800$  km (2013)

LBNE (Fermilab-DUSEL)     $\sim 1200$  km (2020)

SPL+ $\beta$ -beams, UNO (1 megaton):

CERN-Frejus     $\sim 140$  km

$\nu$ -Factories       $\sim 3000, 7000$  km

### Discovery potential at $3\sigma$ in 2018

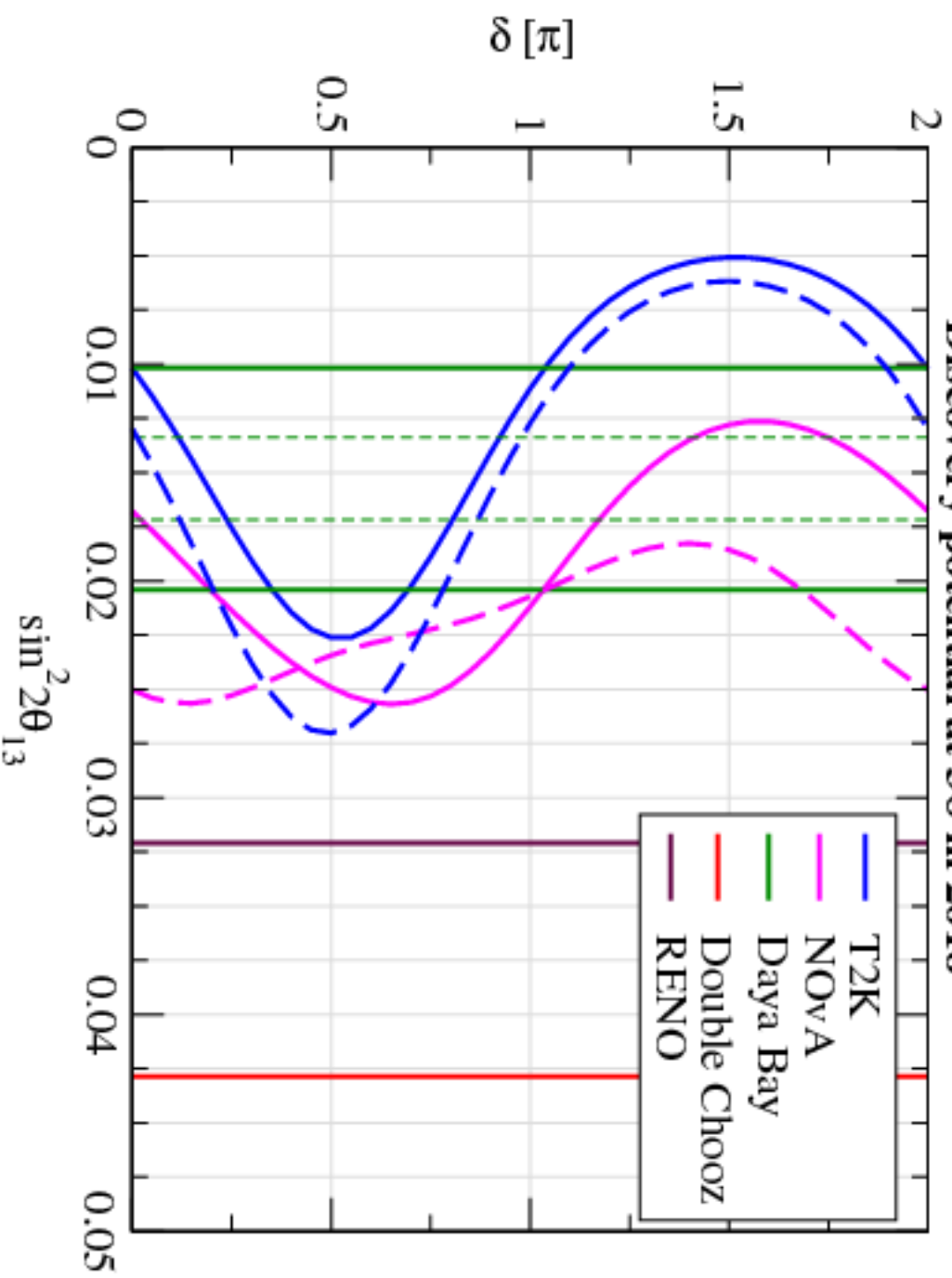

M. Mezzetto, T. Schwetz, arXiv:1003.5800[hep-ph]

## The $(\text{Mass})^2$ Spectrum

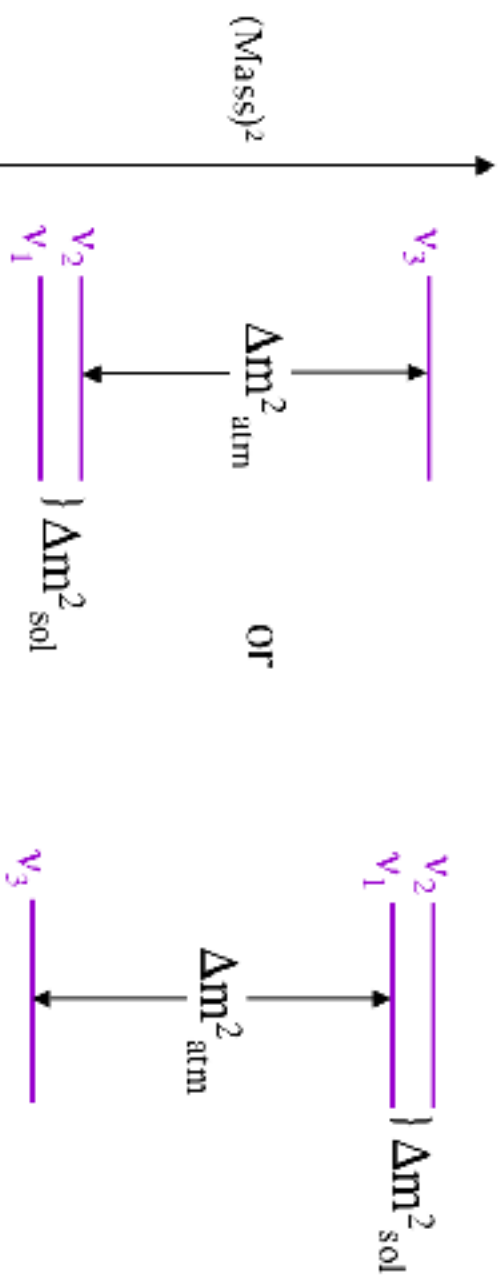

**Normal**

**Inverted**

$$\Delta m^2_{\text{sol}} \cong 7.6 \times 10^{-5} \text{ eV}^2, \quad \Delta m^2_{\text{atm}} \cong 2.4 \times 10^{-3} \text{ eV}^2$$

Are there *more* mass eigenstates, as LSND suggests,  
and MiniBooNE recently hints?

3

If  $\nu_j$  — Majorana particles,  $U_{PMNS}$  contains (3- $\nu$  mixing)

$\delta$ -Dirac,  $\alpha_{21}$ ,  $\alpha_{31}$  - Majorana physical CPV phases

$\nu$ -oscillations  $\nu_l \leftrightarrow \nu_{l'}$ ,  $\bar{\nu}_l \leftrightarrow \bar{\nu}_{l'}$ ,  $l, l' = e, \mu, \tau$ ,

• are not sensitive to the nature of  $\nu_j$ ,

S.M. Bilenky et al., 1980;  
P. Langacker et al., 1987

• provide information on  $\Delta m_{jk}^2 = m_j^2 - m_k^2$ , but not on the absolute values of  $\nu_j$  masses.

The Majorana nature of  $\nu_j$  can manifest itself in the existence of  $\Delta L = \pm 2$  processes:

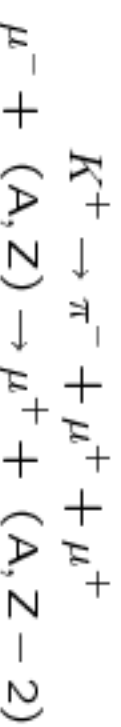

The process most sensitive to the possible Majorana nature of  $\nu_j$  -  $(\beta\beta)_{0\nu}$ -decay



of even-even nuclei,  $^{48}\text{Ca}$ ,  $^{76}\text{Ge}$ ,  $^{82}\text{Se}$ ,  $^{100}\text{Mo}$ ,  $^{116}\text{Cd}$ ,  $^{130}\text{Te}$ ,  $^{136}\text{Xe}$ ,  $^{150}\text{Nd}$ .

$2n$  from  $(A, Z)$  exchange a virtual Majorana  $\nu_j$  (via the CC weak interaction) and transform into  $2p$  of  $(A, Z+2)$  and two free  $e^-$ .



## Nuclear $0\nu\beta\beta$ -decay

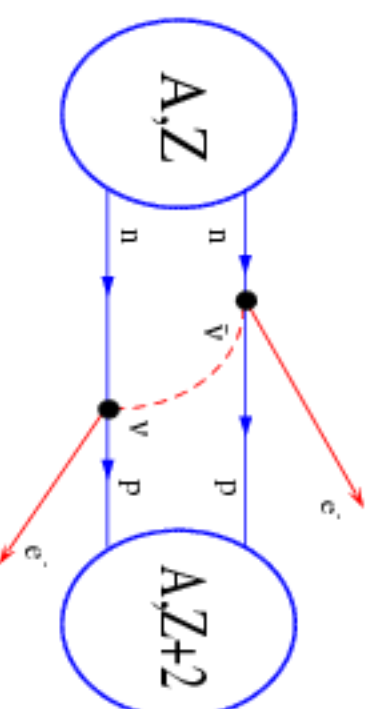

strong in-medium modification of the basic process

$$dd \rightarrow uue^-e^-(\bar{\nu}_e\nu_e)$$

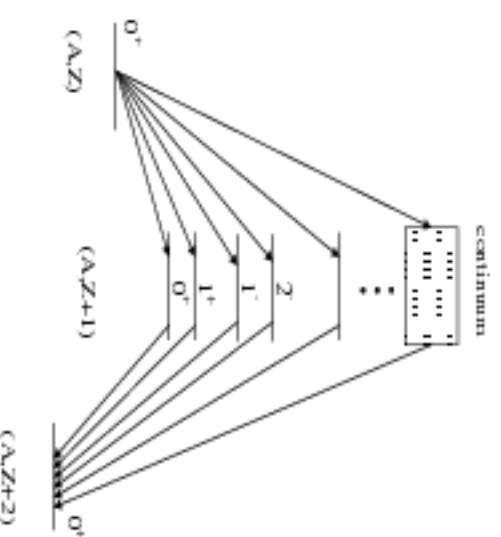

virtual excitation  
of states of all multiplicities  
in  $(A, Z+1)$  nucleus

## $(\beta\beta)_{0\nu}$ —Decay Experiments:

- Majorana nature of  $\nu_j$
  - Type of  $\nu$ —mass spectrum (NH, IH, QD)
  - Absolute neutrino mass scale
- $^3\text{H}$   $\beta$ -decay , cosmology:  $m_\nu$  (QD, IH)
- CPV due to Majorana CPV phases

## $\nu_j$ — Dirac or Majorana particles, fundamental problem

$\nu_j$ —Dirac: **conserved lepton charge exists**,  $L = L_e + L_\mu + L_\tau$ ,  $\nu_j \neq \bar{\nu}_j$

$\nu_j$ —Majorana: **no lepton charge is exactly conserved**,  $\nu_j \equiv \bar{\nu}_j$

The observed patterns of  $\nu$ —mixing and of  $\Delta m_{\text{atm}}^2$  and  $\Delta m_{\odot}^2$  can be related to Majorana  $\nu_j$  and an **approximate** symmetry:

$$L' = L_e - L_\mu - L_\tau$$

S.T.P., 1982

See-saw mechanism:  $\nu_j$ — Majorana

**Establishing that  $\nu_j$  are Majorana particles would be as important as the discovery of  $\nu$ —oscillations.**

$A(\beta\beta)_{0\nu} \sim \langle m \rangle$  M(A,Z),      M(A,Z) - NME,

$$\begin{aligned} |\langle m \rangle| &= |m_1| |U_{e1}|^2 + m_2 |U_{e2}|^2 e^{i\alpha_{21}} + m_3 |U_{e3}|^2 e^{i\alpha'_{31}} \\ &= |m_1 c_{12}^2 c_{13}^2 + m_2 s_{12}^2 c_{13}^2 e^{i\alpha_{21}} + m_3 s_{13}^2 e^{i\alpha'_{31}}|, \quad \theta_{12} \equiv \theta_{\odot}, \theta_{13}\text{-CHOOZ} \end{aligned}$$

$\alpha_{21}$ ,  $\alpha_{31}$  - the two Majorana CPVP of the PMNS matrix;  $\alpha'_{31} \equiv \alpha_{31} - 2\delta$

**CP-invariance:**  $\alpha_{21} = 0, \pm\pi$ ,  $\alpha_{31} = 0, \pm\pi$ ;

$$\eta_{21} \equiv e^{i\alpha_{21}} = \pm 1, \quad \eta_{31} \equiv e^{i\alpha_{31}} = \pm 1$$

**relative CP-parities of  $\mathcal{U}_1$  and  $\mathcal{U}_2$ , and of  $\mathcal{U}_1$  and  $\mathcal{U}_3$ .**

L. Wolfenstein, 1981;

S.M. Bilenky, N. Nedelcheva, S.T.P., 1984;

B. Kayser, 1984.

$$|\langle m \rangle| : m_j, \theta_{\odot} \equiv \theta_{12}, \theta_{13}, \alpha_{21,31}$$

$m_{1,2,3}$  - in terms of  $\min(m_j)$ ,  $\Delta m_{\text{atm}}^2$ ,  $\Delta m_{\odot}^2$

S.T.P., A.Yu. Smirnov, 1994

Convention:  $m_1 < m_2 < m_3$  - **NMO**,  $m_3 < m_1 < m_2$  - **IMO**

$$\Delta m_{\odot}^2 \equiv \Delta m_{21}^2, \quad m_2 = \sqrt{m_1^2 + \Delta m_{\odot}^2},$$

while either

$$\Delta m_{\text{atm}}^2 \equiv \Delta m_{31}^2 > 0, \quad m_3 = \sqrt{m_1^2 + \Delta m_{\text{atm}}^2}, \quad \text{normal mass ordering, or}$$

$$\Delta m_{\text{atm}}^2 \equiv \Delta m_{32}^2 < 0, \quad m_1 = \sqrt{m_3^2 + |\Delta m_{\text{atm}}^2| - \Delta m_{\odot}^2}, \quad \text{inverted mass ordering}$$

The neutrino mass spectrum –

**Normal hierarchical (NH)** if  $m_1 \ll m_2 \ll m_3$ ,

**Inverted hierarchical (IH)** if  $m_3 \ll m_1 \cong m_2$ ,

**Quasi-degenerate (QD)** if  $m_1 \cong m_2 \cong m_3 = m$ ,  $m_j^2 \gg \gg |\Delta m_{\text{atm}}^2|$ ;  $m_j \gtrsim 0.1$  eV

Given  $|\Delta m_{\text{atm}}^2|$ ,  $\Delta m_{\odot}^2$ ,  $\theta_{\odot}$ ,  $\theta_{13}$ ,

$$|\langle m \rangle| = |\langle m \rangle| (\mathbf{m}_{\min}, \alpha_{21}, \alpha_{31}; \mathbf{S}), \quad \mathbf{S} = \text{NO(NH), IO(IH)}.$$

$A(\beta\beta)_{0\nu} \sim \langle m \rangle$  M(A,Z),      M(A,Z) - NME,

$$|\langle m \rangle| \cong \left| \sqrt{\Delta m_{02}^2} \sin^2 \theta_{12} e^{i\alpha} + \sqrt{\Delta m_{31}^2} \sin^2 \theta_{13} e^{i\beta} \right|, \quad m_1 \ll m_2 \ll m_3 \text{ (NH)},$$

$$|\langle m \rangle| \cong \sqrt{m_3^2 + \Delta m_{13}^2} |\cos^2 \theta_{12} + e^{i\alpha} \sin^2 \theta_{12}|, \quad m_3 < (\ll) m_1 < m_2 \text{ (IH)},$$

$$|\langle m \rangle| \cong m |\cos^2 \theta_{12} + e^{i\alpha} \sin^2 \theta_{12}|, \quad m_{1,2,3} \cong m \gtrsim 0.10 \text{ eV (QD)},$$

$\theta_{12} \equiv \theta_{\odot}$ ,  $\theta_{13}$ -CHOOZ;  $\alpha \equiv \alpha_{21}$ ,  $\beta + 2\delta \equiv \alpha_{31}$ .

**CP-invariance:**  $\alpha = 0, \pm\pi$ ,  $\beta_M = 0, \pm\pi$ ;

$$|\langle m \rangle| \lesssim 5 \times 10^{-3} \text{ eV, NH};$$

$$\sqrt{\Delta m_{13}^2} \cos 2\theta_{12} \cong 0.013 \text{ eV} \lesssim |\langle m \rangle| \lesssim \sqrt{\Delta m_{13}^2} \cong 0.055 \text{ eV, IH};$$

$$m \cos 2\theta_{12} \lesssim |\langle m \rangle| \lesssim m, \quad m \gtrsim 0.10 \text{ eV, QD}.$$

Best sensitivity: Heidelberg-Moscow  $^{76}\text{Ge}$  experiment.

Claim for a positive signal at  $> 3\sigma$ :

H. Klappdor-Kleingrothaus et al., PL B586 (2004),

$$|\langle m \rangle| = (0.1 - 0.9) \text{ eV (99.73\% C.L.)}.$$

$$\text{IGEX } ^{76}\text{Ge: } |\langle m \rangle| < (0.33 - 1.35) \text{ eV (90\% C.L.)}.$$

Taking data - NEMO3 ( $^{100}\text{Mo}$ ), CUORICINO ( $^{130}\text{Te}$ ):

$$|\langle m \rangle| < (0.7-1.2) \text{ eV, } |\langle m \rangle| < (0.18-0.90) \text{ eV (90\% C.L.)}.$$

Large number of projects:  $|\langle m \rangle| \sim (0.01 - 0.05) \text{ eV}$

CUORE -  $^{130}\text{Te}$ ,

GERDA -  $^{76}\text{Ge}$ ,

SuperNEMO,

COBRA -  $^{116}\text{Cd}$ ,

EXO -  $^{136}\text{Xe}$ ,

MAJORANA -  $^{76}\text{Ge}$ ,

MOON -  $^{100}\text{Mo}$ ,

CANDLES -  $^{48}\text{Ca}$ ,

XMASS -  $^{136}\text{Xe}$ .

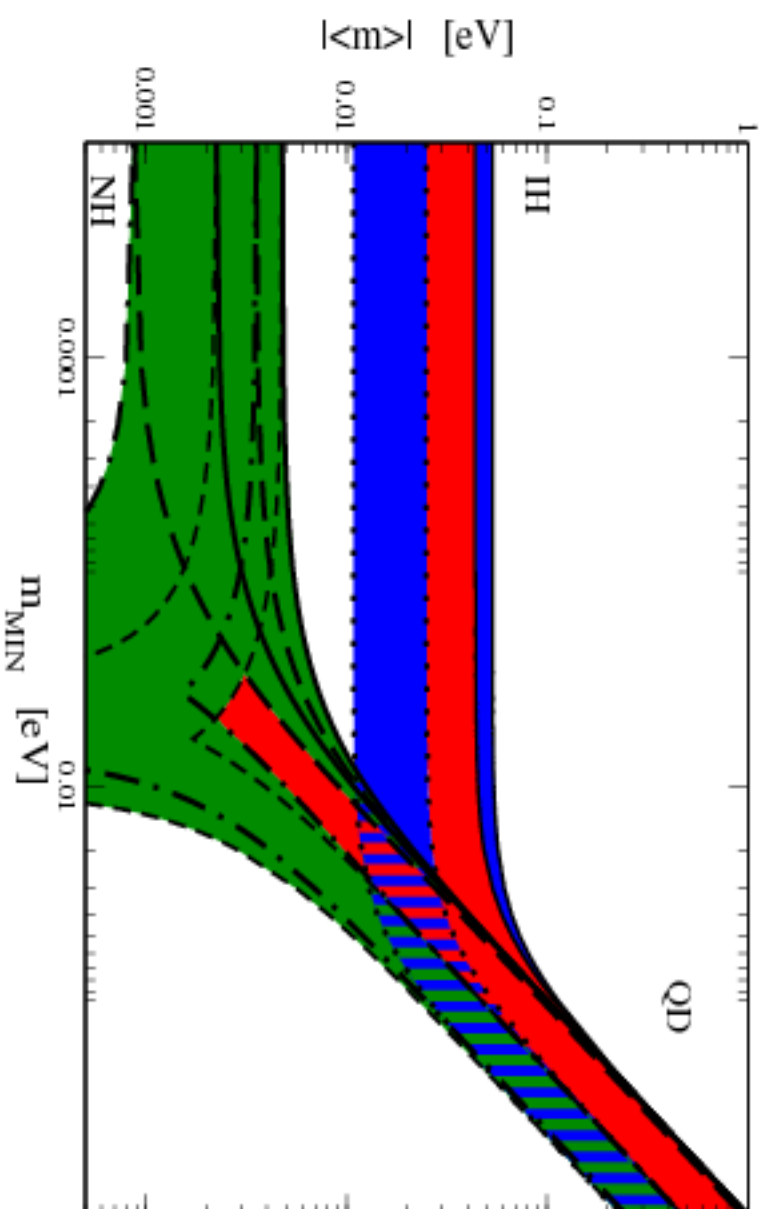

S. Pascoli, S.T.P., 2006

The current  $2\sigma$  ranges of values of the parameters used.

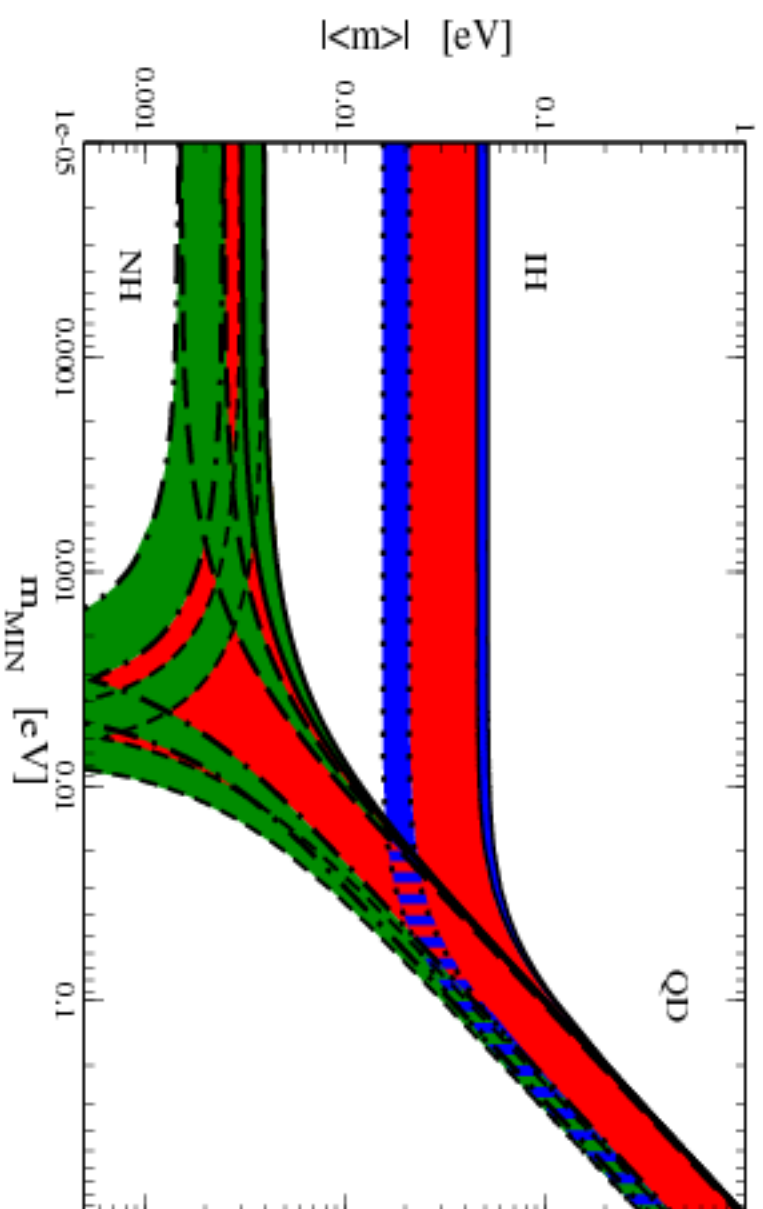

$\sin^2 \theta_{13} = 0.015 \pm 0.006$ ;  $1\sigma(\Delta m_{\odot}^2) = 4\%$ ,  $1\sigma(\sin^2 \theta_{\odot}) = 4\%$ ,  $1\sigma(|\Delta m_{\text{atm}}^2|) = 6\%$ ;

$2\sigma(|\langle m \rangle|)$  used.



## Majorana CPV Phases and $|\langle m \rangle|$

CPV can be established provided

- $|\langle m \rangle|$  measured with  $\Delta \lesssim 15\%$  ;
- $\Delta m_{\text{atm}}^2$  (IH) or  $m_0$  (QD) measured with  $\delta \lesssim 10\%$  ;
- $\xi \gtrsim 1.5$  ;
- $\alpha_{21}$  (QD): in the interval  $\sim [\frac{\pi}{4} - \frac{3\pi}{4}]$ , or  $\sim [\frac{5\pi}{4} - \frac{3\pi}{2}]$  ;
- $\tan^2 \theta_{\odot} \gtrsim 0.40$  .

S. Pascoli, S.T.P., W. Rodejohann, 2002

S. Pascoli, S.T.P., L. Wolfenstein, 2002

S. Pascoli, S.T.P., T. Schwetz, hep-ph/0505226

No “No-go for detecting CP-Violation via  $(\beta\beta)_{0\nu}$ -decay”

V. Barger et al., 2002

# Absolute Neutrino Mass Measurements

The Troitzk and Mainz  $^3\text{H}$   $\beta$ -decay experiments

$$m_{\nu_e} < 2.3 \text{ eV} \quad (95\% \text{ C.L.})$$

There are prospects to reach sensitivity

$$\text{KATRIN : } m_{\nu_e} \sim 0.2 \text{ eV}$$

Cosmological and astrophysical data: the WMAP result combined with data from large scale structure surveys (2dFGRS, SDSS)

$$\sum_j m_j \equiv \Sigma < (0.4 - 1.7) \text{ eV}$$

The WMAP and future PLANCK experiments can be sensitive to

$$\sum_j m_j \cong 0.4 \text{ eV}$$

Data on weak lensing of galaxies by large scale structure, combined with data from the WMAP and PLANCK experiments may allow to determine

$$\sum_j m_j : \quad \delta \cong 0.04 \text{ eV.}$$

Improved  $\beta$  energy resolution requires a **BIG**  $\beta$  spectrometer.







## $M_\nu$ from the See-Saw Mechanism

P. Minkowski, 1977.  
M. Gell-Mann, P. Ramond, R. Slansky, 1979;  
T. Yanagida, 1979;  
R. Mohapatra, G. Senjanovic, 1980.

- Explains the smallness of  $\nu$ -masses.
- Through **leptogenesis theory** links the  $\nu$ -mass generation to the generation of baryon asymmetry of the Universe  $Y_B$ .

S. Fukugita, T. Yanagida, 1986.

- In SUSY GUT's with see-saw mechanism of  $\nu$ -mass generation, the LFV decays

$$\mu \rightarrow e + \gamma, \quad \tau \rightarrow \mu + \gamma, \quad \tau \rightarrow e + \gamma, \text{ etc.}$$

are predicted to take place with rates within the reach of present and future experiments.

F. Borzumati, A. Masiero, 1986.

- The  $\nu_j$  are **Majorana particles**;  $(\beta\beta)_{0\nu}$ -decay is allowed.

**See-Saw**: Dirac  $\nu$ -mass  $m_D$  + Majorana mass  $M_R$  for  $N_R$

**Instead of Conclusions**

We are at the beginning of the Road...

The future of neutrino physics is bright.

## Supporting Slides

The  $\beta$  energy spectrum is modified according to —

$$(E_0 - E)^2 \Theta[E_0 - E] \Rightarrow \sum_i |U_{ei}|^2 (E_0 - E) \sqrt{(E_0 - E)^2 - m_i^2} \Theta[(E_0 - m_i) - E]$$

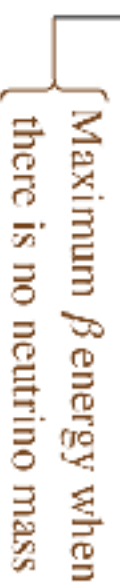



Present experimental energy resolution is insufficient to separate the thresholds.

Measurements of the spectrum bound the average neutrino mass —

$$\langle m_\beta \rangle = \sqrt{\sum_i |U_{ei}|^2 m_i^2}$$

Presently:  $\langle m_\beta \rangle < 2 \text{ eV}$

Mainz & Troitzk

?