





An introduction to VMEbus

Overview

- What you already should know
- VMEbus
 - Introduction
 - Addressing
 - Single cycles
 - Block transfers
 - Interrupts
 - VME64x
- System assembly
- Single Board Computer
- Software
- Tools



What you already should know

- C(++) programming
 - use of pointers 
 - signals 
 - data types (char, short, int) 
 - use of C++ methods 
- Linux
 - CVS / CMT
 - Makefiles
 - gdb
 - Shared libraries
 - Usually the environment variable `LD_LIBRARY_PATH` tells the linker where to find shared libraries
 - Handling drivers 
 - General operation (cd, ls, mkdir, etc.)

VMEbus mechanics

VMEbus cards exist in 3 standard heights: 3U, 6U and 9U

Definition: 1U = 1.75 inch

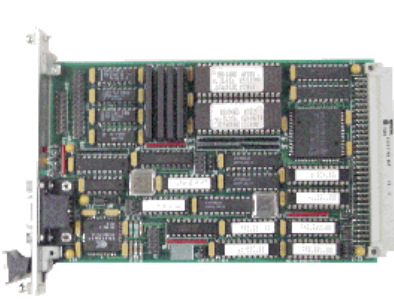

In 6U and 9U systems there can be transition modules installed on the rear side of the backplane. Transition modules do not connect to VMEbus but just to the VMEbus module on the opposite side of the backplane via the user defined pins of the J0, J2 and J3 connectors

VMIEbus mechanics (2)

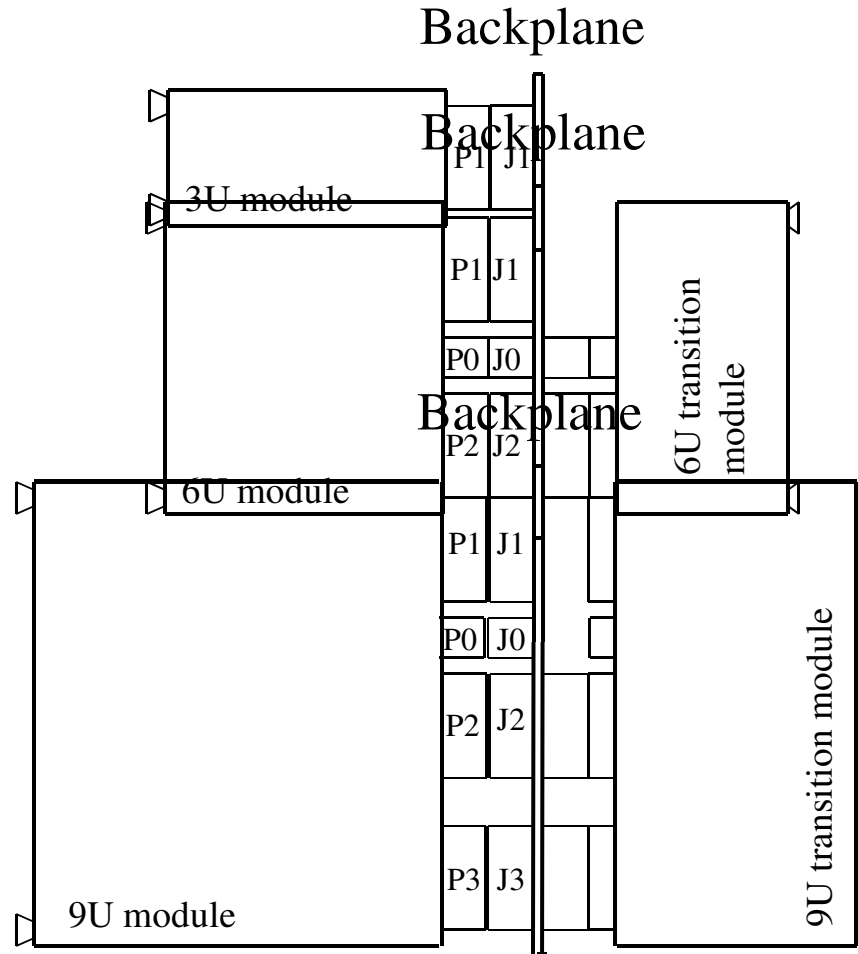

VMEbus mechanics (3)

Example: 6U VME64x module

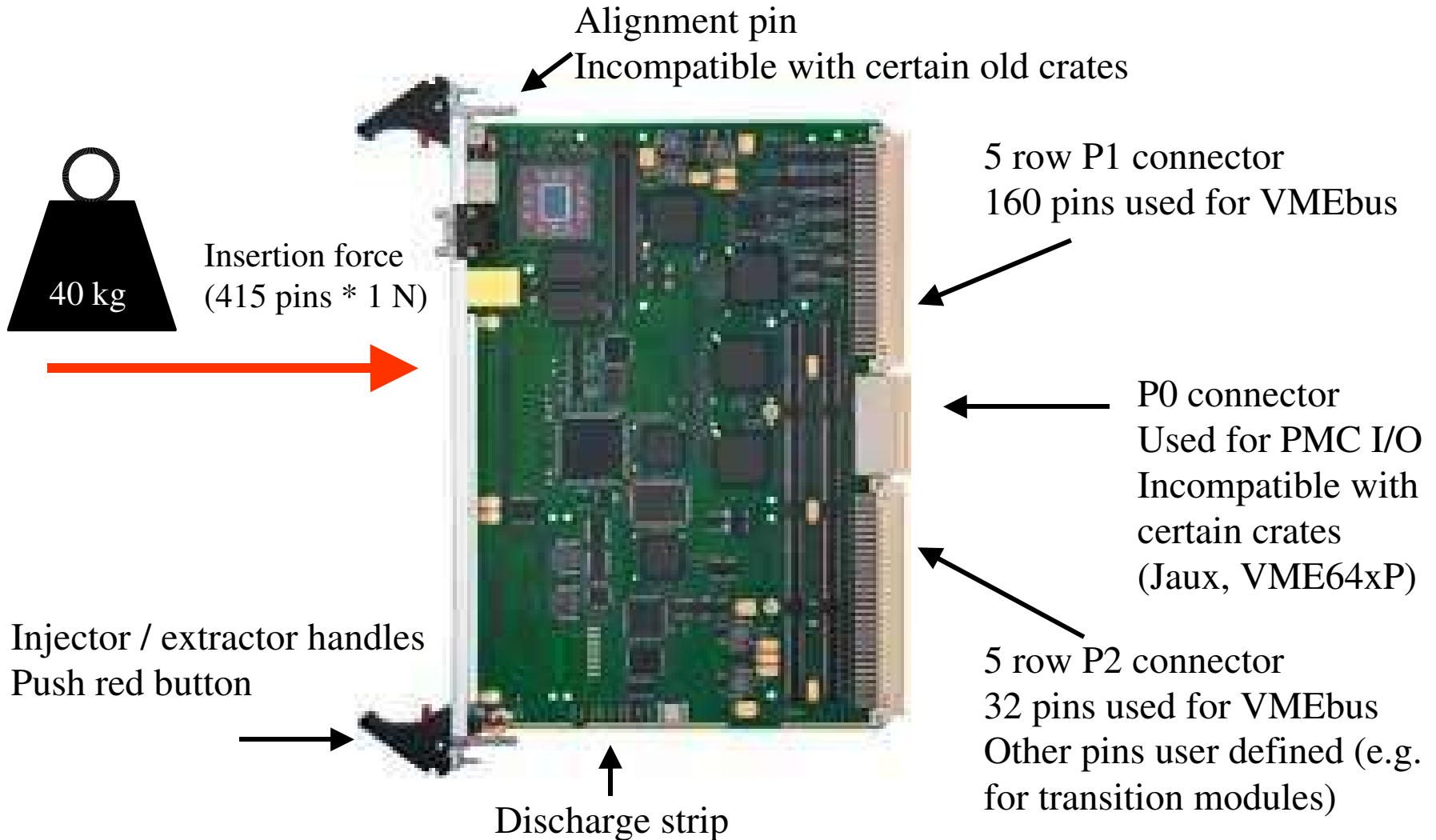

VMEbus crates



21 slot 6U crate
for 19" racks

21 slot 9U crate
(with 6U section)
for 19" racks

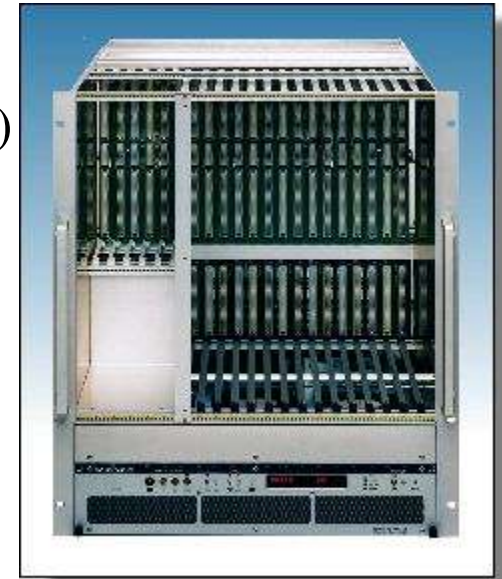

- There are different types of power supplies (5V, +/- 12V, 3.3V, 48V) mounted locally or remote
- The fan-tray unit allows to monitor parameters like voltages, currents, fan speed, temperature
- (Some) crates can be controlled by a field bus (CAN)
- **ATTENTION:** The EMC gasket to the left of slot 1 may damage your VMEbus cards

VMEbus Backplane

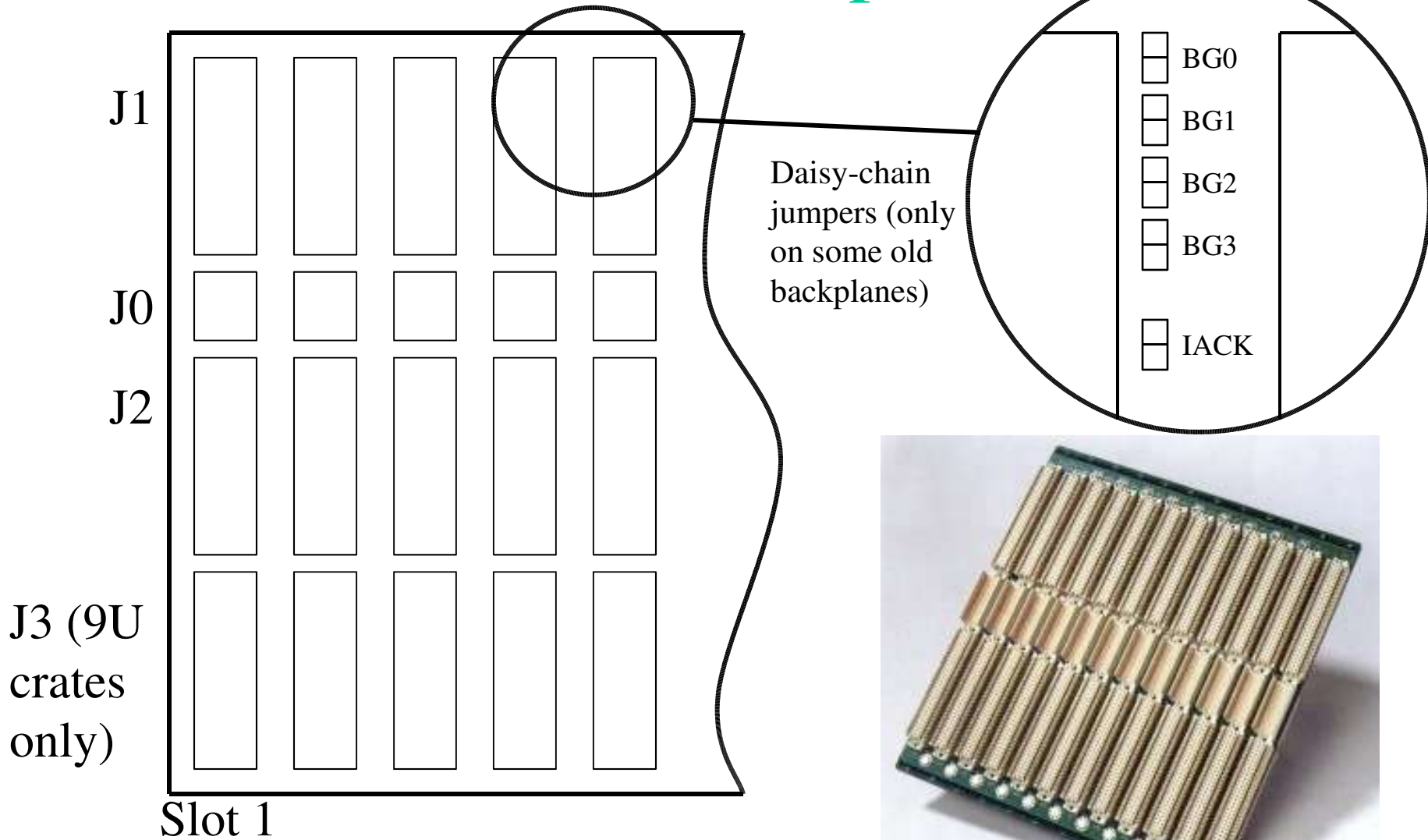

Front view

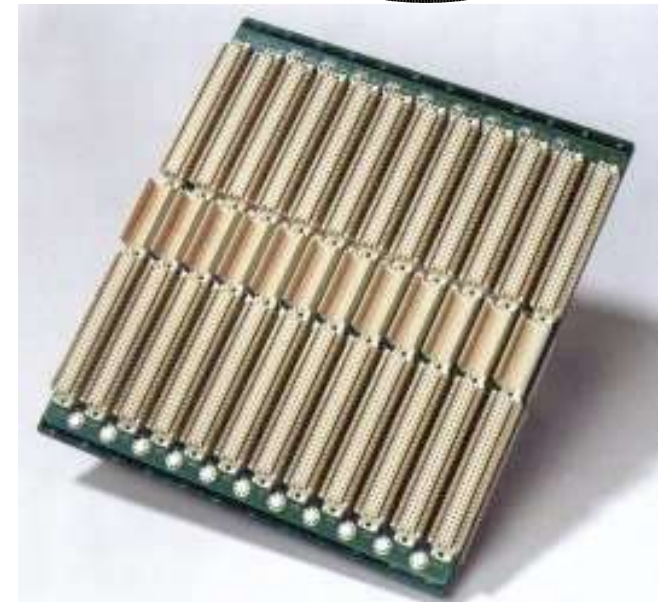

6U VME64x backplane



VMEbus basics

- Electrical properties
 - All lines use TTL levels
 - Low = 0 ... 0.6 V
 - High = 2.4 ... 5 V
 - Address, address modifier and data lines are active high
 - Protocol lines are active low
- Protocol
 - Asynchronous with 4-edge handshaking.
 - The duration of a VMEbus cycle depends on the speed of the master and the slave
- Byte ordering
 - VMEbus is big endian. It stores the most significant byte of a word at the lowest byte address (0x0)
 - PCI and Intel CPUs are little endian. They store the most significant byte of a word at the highest byte address (0x3)
 - Most VMEbus masters (e.g. VP110) have automatic byte swapping logic

VMEbus basics(2)

- Types of common modules (physical and logical)
 - Master
 - A module that can initiate data transfers
 - Slave
 - A module that responds to a master
 - Interrupter
 - A module that can send an interrupt (usually a slave)
 - Interrupt handler
 - A module that can receive (and handle) interrupts (usually a Single Board Computer)
 - Arbiter
 - A piece of electronics (usually included in the SBC) that arbitrates bus access and monitors the status of the bus. It should always be installed in slot 1 of the VMEbus crate

VMEbus basics(3)

- Main types of data transfers
 - Single cycles
 - Transfer 8, 16 or 32 bits of data (typically) under the control of the CPU on the master
 - Typical duration: 1 us
 - Block transfer (DMA)
 - Transfer any amount of data (usually 32 or 64 bit at a time) under the control of a DMA controller (CPU independent)
 - Data is transferred in bursts of up to 256 (D32) or 2048 (D64) bytes
 - Typical duration: 150 ns per data word
 - Interrupts
 - Used typically by slaves to signal a condition (e.g. data available, internal error, etc.)
 - Can (in principle) have 7 priorities
 - The interrupter provides an 8-bit vector on request of the interrupt handler to identify itself
 - ROAK (Release on Acknowledge) or RORA (Release On Register Access)

VMEbus protocol

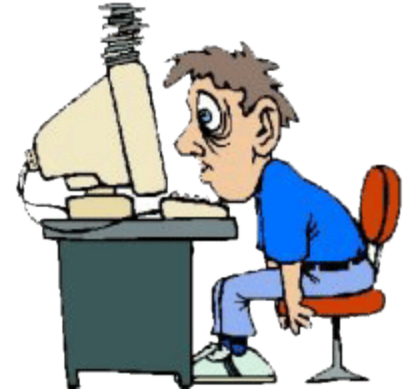



Why do I have to understand how the protocol works if I am not designing cards?

- Some designers make mistakes and their VMEbus cards do not work at all or fail in combination with certain other cards
- Debugging VMEbus traffic by S/W (printf(), gdb, etc.) is difficult or even impossible
- A great help for fixing such problems are VMEbus analyzers
- A VMEbus analyzer also tells you if you are really executing the desired types of cycles (D8, D16, D32, etc.)
- In order to understand the output of such an analyzer you have to have some knowledge of the protocol

Important signals

Name	Description
BBSY*	Bus Busy. Once a master has been granted the bus it drives BBSY*. As long as BBSY* is asserted no other master can get the bus
A[31..1]	Address lines (can carry data in D64 multiplexed transfers)
D[31..0]	Data lines
AM[5..0]	Address modifier. Defines the number of valid address bits and cycle type 
DS0* and DS1*	Data strobes. Tell the slave when the master is ready. Also encode the number of bytes to be transferred
LWORD*	Contributes to the definition of the transfer size and carries data in MBLT cycles
AS*	Address Strobe. Tells the slaves when the address on the bus is valid
WRITE*	Defines the direction of the data transfer
DTACK*	Data acknowledge. Used by a slave to tell the master that it has read / written the data
BERR*	Bus error. Used by slaves or arbiters to signal errors
IRQ1* .. IRQ7*	Interrupt request lines. Asserted by the interrupter
IACK*	Interrupt acknowledge. Used by the interrupt handler to retrieve an interrupt vector from the interrupter

Arbitration

- Before a master can transfer data it has to request the bus. It does this by asserting one of the four bus request lines
 - The lines (BR0, BR1, BR2 and BR3) can be used to prioritize requests in multi-master systems 
- The arbiter (usually in slot 1) knows (by looking at the BBSY line) if the bus is busy or idle. Once it is idle it asserts one of the four Bus Grant out lines (BGOUT 0..3)
- If a master detects a 1 on the BGIN line corresponding to its BR it claims the bus by asserting BBSY (otherwise it passes BGIN on to BGOUT to close the daisy chain) 

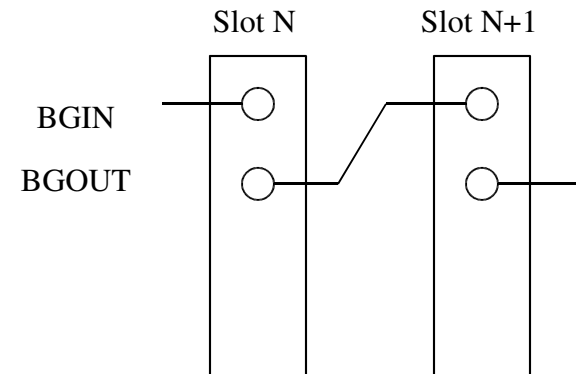
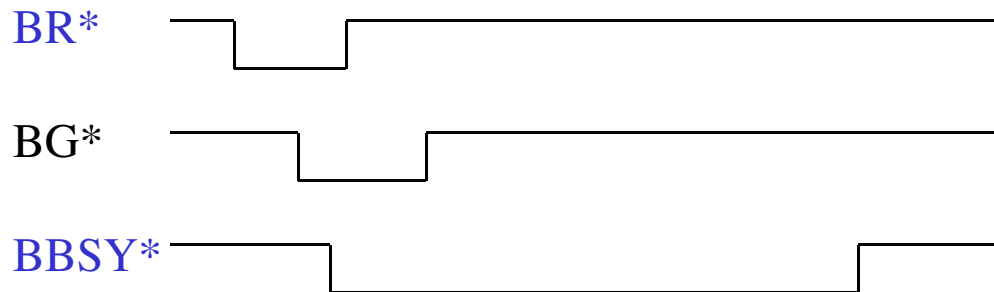

Color code: Arbiter - Master

Arbitration (2)

- The arbiter can use different schemes: PRI (priority based), RRS (round robin)
 - Not an issue for single master systems
- If two masters use the same bus request level the one closer to slot 1 inherently has a higher priority (because it detects BGIN first)
- Modern masters support “fair arbitration”. I.e. they delay their bus request if other masters are requesting the bus at the same level
- A master may get stuck if the BG daisy chain is not closed

Addressing

- The VMEbus backplane has 31 address lines: A01..A31
- There is no A00 address line on the backplane. This information is encoded in the DS0/1 protocol lines
- A slave is selected by two criteria:
 - Address (usually 16, 24 or 32 valid bits)
 - Address modifier (6 bits). It defines: 
 - The number of valid address bits
 - The access mode (user/supervisor, program/data, CR/CSR)
 - The transfer type (single cycle or block transfer)
- Typically slaves respond to only one address width (A16, A24 or A32; read the manual of the slave) but may allow both single cycles and block transfers
- The base address of a slave can be set:
 - Mechanically: on-board Jumpers, DIP switches
 - By S/W: VME64x geographical addressing, CR/CSR

Addressing protocol

- First the master drives AM, Address and LWORD*. Then it waits 35 ns and finally drives AS* to validate the information
- The slave has to decode the address information within 40 ns (even though most masters keep AS* asserted much longer)
- The master does not know if a slave has accepted the address information. It continues with the data transfer until it either receives a DTACK* or a BERR*
- If two or more slaves believe to be addressed you have a problem...

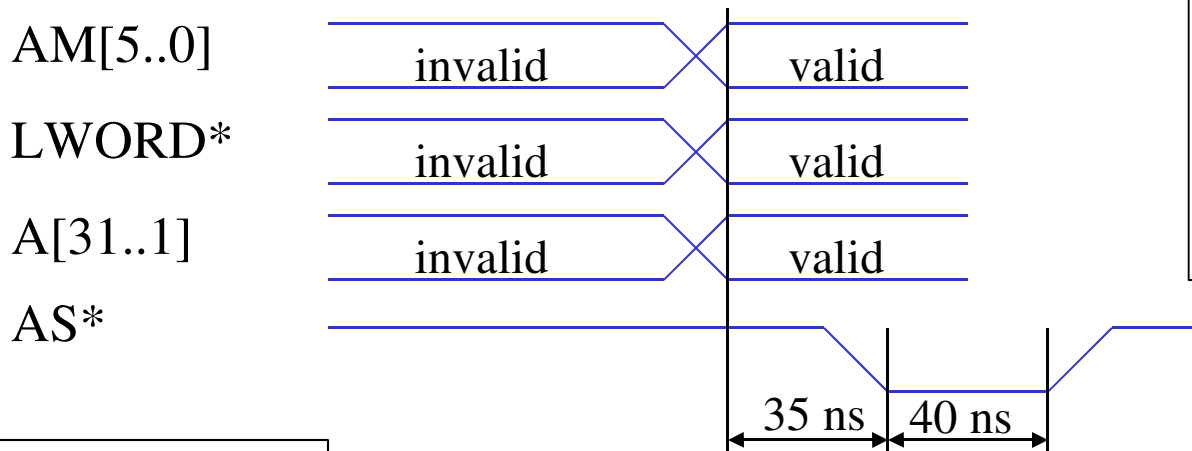

The timing parameters mentioned here are two of about 50 in the VMEbus standard. The standard also distinguishes master and slave timing (bus skew)

Color code: **Master**

Single cycles

Example: (Simplified) write cycle

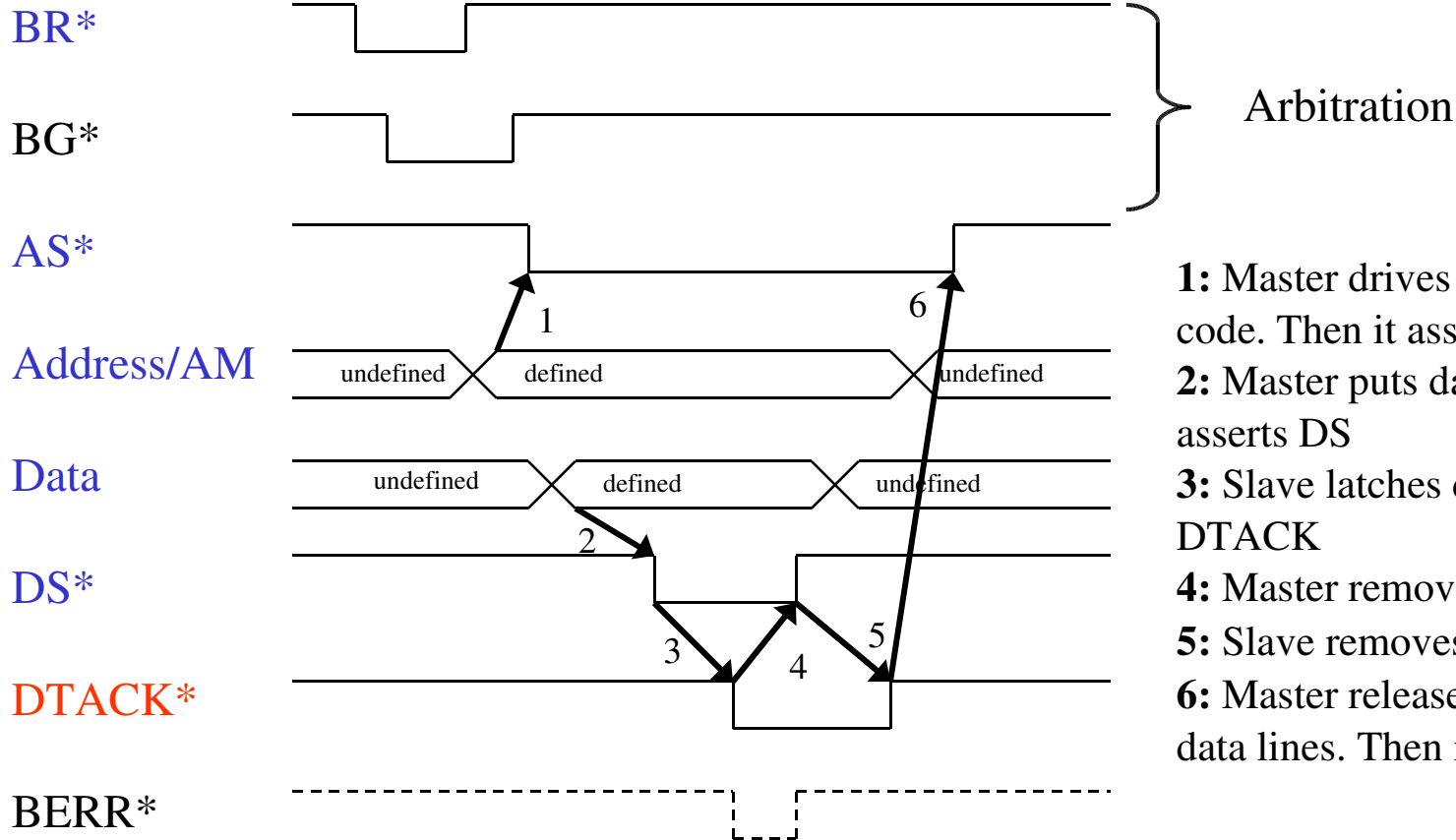

- 1:** Master drives address and AM code. Then it asserts AS
- 2:** Master puts data on the bus. Then it asserts DS
- 3:** Slave latches data and drives DTACK
- 4:** Master removes DS
- 5:** Slave removes DTACK
- 6:** Master releases Address, AM and data lines. Then it releases AS

Color code: Master - Slave - Arbiter

Single cycles (2)

- The number of bytes to be transferred (1, 2 or 4) is encoded in the DS0, DS1 and LWORD protocol lines
- Remember that some slaves support only certain data widths (e.g. D8 and D16 but not D32)
- The VMEbus address should be aligned to the data size
 - Reading a D32 word e.g. from address 0x000003 may not be a good idea
- VMEbus also supports (rarely used) read-modify-write cycles (useful for semaphores)
- Remember that VMEbus is big endian. Example:

Address	Action	Result
0x00000000	D32 write 0x11223344	--
0x00000000	D32 read	0x11223344
0x00000000	D8 read	0x11
0x00000003	D8 read	0x44

Block transfers

Example: D32 write

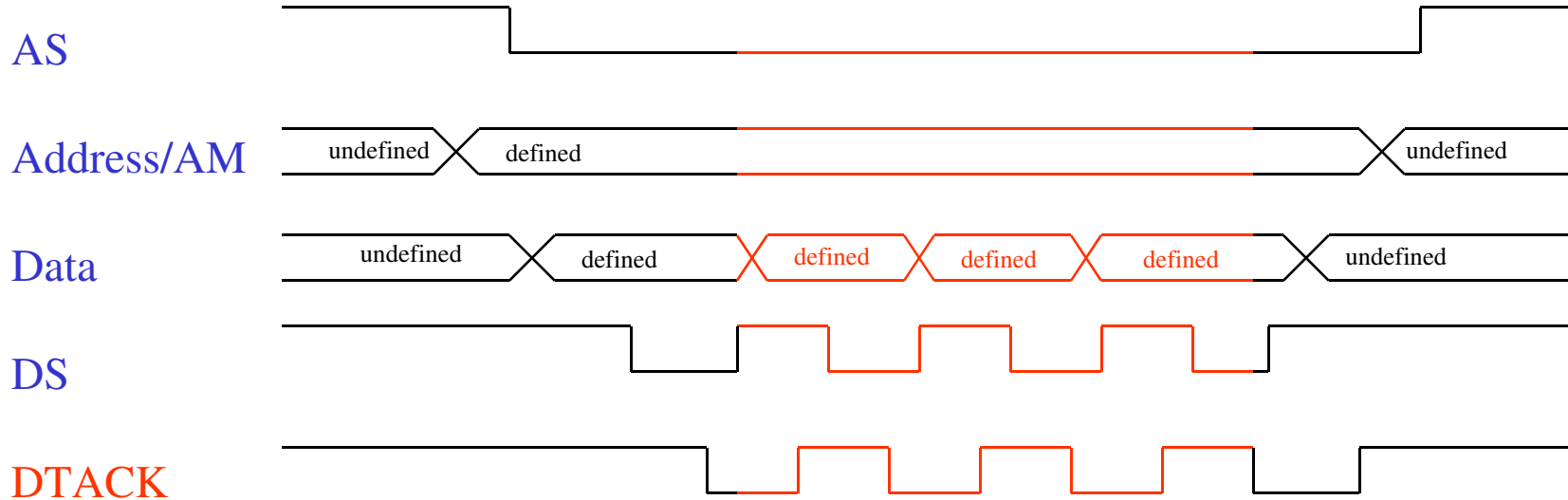

- The Block transfer protocol is based on the single cycle protocol
- The address lines on the backplane do not change state during the transfer. Both master and slave use internal counters to keep track of the address
- As the address lines are not used they can carry data: 64-bit multiplexed DMA. In this case the slave uses DTACK for two purposes:
 - Directly after AS being asserted to acknowledge the address
 - After each assertion of DS to acknowledge the data

Color code: Single cycle protocol – **block transfer**

Block transfers (2)

- A master must not cross a 256 bytes (D32) or 2048 bytes (D64) address boundary respectively without releasing AS (transparent to the user)
 - This is to give other masters a chance to acquire the bus before too long
- Reading out single address FIFOs is not foreseen by the standard and requires special masters
- Designing a slave that terminates a block transfer from a FIFO with a bus error is legal but bad practice. It does not always work with the Tundra Universe 
- VMEbus interface chips may require a relative alignment of the VMEbus and local (PCI) addresses
 - In case of the Tundra Universe the VMEbus and PCI addresses must be 8-byte aligned with respect to each other
- Contiguous buffers
 - Memory obtained with `malloc()` may be fragmented. Most DMA controllers, however, need contiguous buffers
 - Contiguous buffers are provided by special drivers (e.g. ATLAS: `cmem_rcc`) based on kernel functions (`get_free_pages`) or extensions of the Linux kernel (`BigPhysArea`)

VMEbus typical performance

- Being a handshaked, asynchronous protocol there is no fixed transfer rate such as for e.g. RS232. The timing parameters (see VMEbus standard) however set an upper limit.
- Single cycles: Typical performance = 1 μ s per transfer
 - D8 = 1 MB/s
 - D16 = 2 MB/s
 - D32 = 4 MB/s
- **Write posting** decouples PCI and VMEbus cycle. This increases the performance to ~ 10 MB/s for D32 
- Block transfers
 - D32 = 20..25 MB/s (theoretical: 40 MB/s)
 - D64 = 40..50 MB/s (theoretical: 80 MB/s)

Bus errors

- In VMEbus errors can occur under two conditions
 - A slave has been addressed but is incapable of performing the requested transfer. In this case the BERR signal is issued by the slave and reaches the master within a few μs .
 - The master has issued an address that no slave recognizes. Such cycles get terminated by the bus monitor (arbiter) by asserting BERR after a programmable delay (typical values are 16 or 256 μs)
- There is no standard way for the delivery of a BERR from the VMEbus interface to the CPU of the master
 - On PowerPCs BERR is typically converted directly to a non-maskable interrupt and then converted to the SIGBUS signal by the operating system
 - Certain Intel based SBC ignore bus errors
 - Other Intel based SBCs convert it to a regular PCI interrupt. This interrupt is typically handled by the VMEbus driver and converted to the SIGBUS signal



Interrupts

- VMEbus provides 7 interrupt levels (= bus lines) to prioritize interrupts
- Each interrupter can use any level
- There must only be one interrupt handler for each level
- The interrupt handler uses (under H/W control) a special type of single cycle (IACK cycle) to obtain an 8-bit vector from the interrupter. This vector (set by jumpers or S/W) must be unique (within the crate) and identifies the source of the interrupt
- There are two types of interrupters:
 - ROAK (preferred)
 - The IACK cycle clears the interrupt
 - RORA
 - The interrupt is cleared by an additional register access (single read or write cycle)
- Typically an interrupt gets handled by the H/W in a few μ s (once the VMEbus is free). There can be additional (possibly large) S/W overheads depending on the operating system used and the state of the CPU
- If two interrupters are active at the same time and on the same level the one closer to slot 1 will be serviced first (IACK daisy chain)

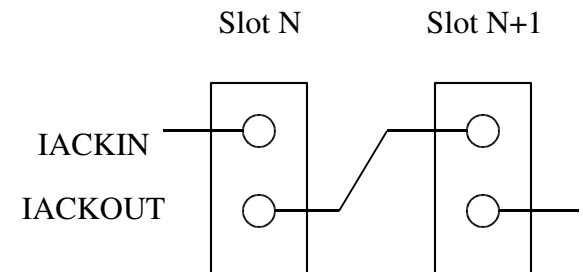

VME64x

- VME64x is a set of extensions to the VMEbus standard made in 1997
- Most features are optional and fall into one of four categories:
 - Mechanics
 - 5-row P1/J1 and P2/J2 connectors
 - J0/P0 connector
 - Alignment pin
 - EMC gaskets
 - Injector / extractor handles
 - Discharge strips
 - Card keys
 - Solder side covers
 - Plug-and-play
 - Geographical addressing (access a module by its slot number)
 - CR/CSR space: Standardised registers for the automatic configuration of a module (base address(es), interrupt vector(s), etc.)
 - Power
 - 3.3 V and 48 V
 - Additional 5 V
 - 2eVME Protocol: A rarely used way of speeding up block transfers (theoretical bandwidth: 160 MB/s)

CR/CSR space access and geographical addressing

- “Classic” VMEbus slaves use on-board jumpers or switches for the initialization of the base address and the interrupt vectors
- The VME64(x) standard proposes a S/W based mechanism (plug-and-play)
The basic principles are:
 - Each slave has a special window of 512 kB consisting of a Configuration ROM (CR) and a Control and Status Register (CSR) section
 - Access to this window is in A24 mode with AM=0x2f only
 - The address of that window (BAR) is either set by jumpers (VME64) or derived from the slot number (geographical addressing, VME64x) with the formula:
address = slot# * 0x80000
 - The CR/CSR space contains many (mostly optional) features to specify and control the functions of a slave board
 - Slave boards are identified by a manufacturer + board ID stored in the CR. Board IDs have to be unique (<http://cern.ch/boardid>)
 - The most important CSR space registers are the eight ADER registers. They are used to define the base address(es) of the main function(s) of the slave.

2eSST

- 2eSST = 2 edge Source Synchronous Transfer
- A recent (1999) addition to the VME64x standard
- It defines a synchronous protocol for VMEbus block transfers
- Three transfer speeds are defined: 160, 267 and 320 MB/s (8 bytes @ 20, 33.3 and 40 MHz)
- Allows for data broadcast and multicast
- Works only reliably on high quality backplanes (incident wave switching) and special (Texas Instruments) driver chips
- There exist (so far) only a hand full of VMEbus modules built to this standard

The VMEbus single board computer

- Usually this is the only master and interrupt handler in the crate
- It often also provides the arbiter functionality (and should therefore be installed in slot 1, despite what is said about cooling)
- It behaves like a normal PC
 - Operating system: Linux, (LynxOS, Windows)
 - Development tools: gcc, g++, gdb
 - Environment: Shell, Xterm, vi, emacs
 - Accessed via: RS232, Ethernet, (VGA)
- It interfaces to VMEbus via a PCI device
 - Typically Tundra Universe
 - Depending on the model and the S/W used it has to be configured in the BIOS or at start-up by special programs
- The PowerPC CPU does instruction reordering. Use the “eieio” assembler instruction to enforce the proper order of execution
- Some SBCs can be equipped with mezzanines (PMC, IP) but this is another story

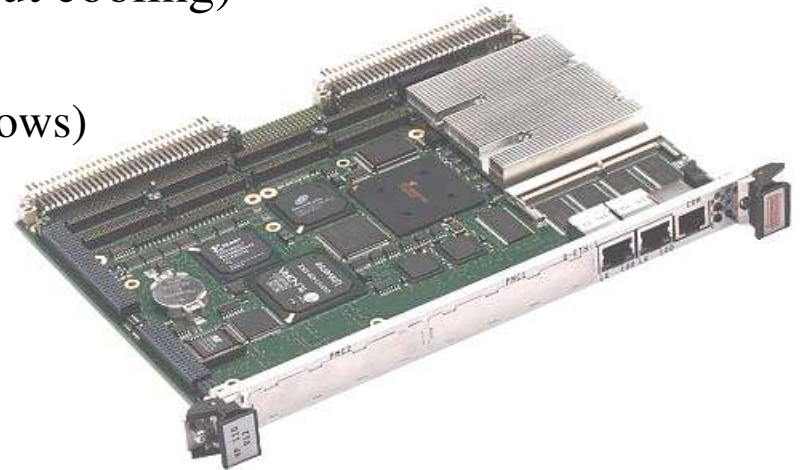

The VP110 SBC

- This SBC (manufactured by Concurrent Technologies) is the default SBC for ATLAS ROD crates
- Recently ALICE has decided to use it for most VMEbus systems
- You can rent this processor from the El. Pool

CPU	Pentium III @ 800 MHz
RAM	512 MB
VMEbus interface	Tundra Universe
PMC sites	Two. 32 or 64 bit, 33 or 66 MHz, (can be configured for 5V or 3.3V signaling)
Mass storage	Connection of IDE hard disks and floppy drives possible via P2 adapter board (requires 5-row VME64x backplane) A hard disk can also be installed on-board. This takes one of the PMC slots
Network interface	Two channels, 10 / 100 Mbit/s, RJ45 on front panel (based on the 82559ER interface chip)
Mechanics	VME64x compliant: 5-row P1 and P2, P0 (optional), front panel with alignment pin and injector / extractor handles (alternative solution for 3-row VME backplanes exists), solder side cover
Terminal connection	RS232 via front panel RJ45 connector, no VGA / mouse / keyboard (can be added by additional PMC module)

Other VMEbus masters and interfaces

- PC to VMEbus interfaces
 - Available from several manufacturers
 - A set typically consists of a PCI card, a VMEbus card and a cable (copper or optical fiber)
 - Example: National Instruments MXI-2
 - Allows to control several VMEbus crates from one PC
 - Library support for LabView and standard C
- VMEbus repeaters
 - Allows a master in crate 1 to access a slave in crate 2
 - A set consists of two VMEbus cards and a cable
 - There is usually a performance penalty
- VMEbus to CAMAC interface
 - Allows a master in a VMEbus crate to control a CAMAC crate
 - A set consists of a VMEbus slave, a CAMAC crate controller and a cable
- You can get such interfaces from the CERN El. Pool

Subsystem buses

The P0, P2 and P3 connectors have a number of user defined pins. They can be used to implement specialized communication channels independently from the VMEbus protocol. Examples:

- VSB (VME Subsystem Bus)
 - Obsolete.
 - Provides a 32 bit bus for up to 8 adjacent cards.
 - Was used to interface to FASTBUS
- VXS
 - A recent addition to the standard.
 - It allows each VMEbus card to connect to a switch fabric.
 - Initially it uses the Ethernet protocol but other technologies (e.g. Infiniband) are being discussed
- Custom P3
 - In 9U crates the P3 is totally user defined.
 - Special backplanes are possible too

System integration

- Find the right crate for your modules
 - J0 / Jaux incompatibility
 - VME64x (alignment pin, geographical addressing)
- Find out if your crate still has BG/IACK jumpers
 - Rule: Each slot must be equipped with **1 card** or **5 jumpers** 
 - **Attention:** Jumpers may be on either side of the J1 connector depending on backplane type
- Card handling and insertion
 - VMEbus cards can be sensitive to electrostatic discharge. Take precautions
 - Never add or remove a card if the crate is switched on
 - Depending on the type of module the insertion force is between 20 and 50 kg. Check twice that the card really has been inserted properly!!
 - Do not trust LEDs on the front panel. On certain (VME64x) cards the power pins are longer than the protocol pins.
- Cooling
 - Avoid installing CPUs in the leftmost or rightmost slot (there are special arbiter modules)
 - Leave one or two slots empty between cards, if possible
 - Close the front of the crate with blind panels
 - Check the fan speed
 - Use programs (e.g. thermo) to read the temperature of the SBC
- Address lay-out
 - Check that the address windows of the slave modules do not overlap
 - Try to map similar slaves (e.g. A32, A24) to consecutive addresses

VMEbus S/W

(Linux) Drivers

- In (almost) all cases access to the VMEbus is via a device driver
- The driver allows to use the VMEbus in multi-processing environments
- In some drivers the read() / write() functions are used to access the VMEbus
- Most transactions are implemented by ioctl() functions
- Interrupts are handled by the driver and signalled to the user application e.g. by means of signals or semaphores
- The drivers typically provide DMA request lists. A block transfer may therefore not take place immediately but be delayed by other DMA requests
- The device nodes (/dev/XYZ) created by different drivers are not standardized

Libraries

- The driver is not used directly by the application but via a user library
- There is no standard API (despite VISION) for such libraries
- The API of the library developed for ATLAS can be found at:
<https://edms.cern.ch/document/325729/4>

Debugging tools

- (Linux) S/W
 - Look at the /proc file of the driver
 - In the ATLAS package you find special applications
 - scanvme: Scan VMEbus for modules
 - vme_rcc_test: Use the functions of the library interactively. This program is also a good programming example
 - cctscope: Decode and dump the configuration of the Universe chip (and some other VMEbus related resources) in human readable form

cctscope example output of function 2/2:

```
=====
```

LSI	VME address range	PCI address range	EN	WP	VDW	VAS	AM	Type	PCI space
0	00000000-10000000	90000000-a0000000	Yes	No	D32	A32	UD	SC	PCI MEM
1	00000000-01000000	a0000000-a1000000	Yes	No	D32	A24	UD	SC	PCI MEM
2	00000000-00010000	a1000000-a1010000	Yes	No	D32	A16	UD	SC	PCI MEM
3	00000000-01000000	a2000000-a3000000	Yes	No	D32	CR/CSR	UD	SC	PCI MEM
4	00000000-ffffffff	00000000-ffffffff	No	No	D32	A32	UD	SC	PCI MEM
5	00000000-00000000	00000000-00000000	No	No	D32	A32	UD	SC	PCI MEM
6	00000000-00000000	00000000-00000000	No	No	D32	A32	UD	SC	PCI MEM
7	00000000-00000000	00000000-00000000	No	No	D32	A32	UD	SC	PCI MEM

```
=====
```



Debugging tools (2)

- H/W
 - VMetro VBT325 bus analyzer
 - Stores up to 16000 VMEbus cycles
 - Powerful trigger and sequencer
 - Supports protocol analysis
 - To operate it you need a VT100 (Falco) terminal or a PC with a terminal program (e.g. HypeTerm, minicom, kermit)
 - Can be rented at the El. Pool
 - CES VMDIS8004
 - Low cost bus monitor. Displays the most recent cycle
 - Can latch the first cycle with a bus error or an interrupt
 - Has a built in arbiter (useful if SBC runs hot in slot 1)
 - Can be rented at the El. Pool

The vme_rcc package

- The vme_rcc package contains the default VMEbus driver and library for ATLAS Read-Out Crate Controllers (RCC)
- Documentation: <https://edms.cern.ch/document/325729/4>
- In can of course also be used for other projects
- Supported H/W: Concurrent Technologies VP110 as well as VP-PMC, VP-CP1, etc. Porting to other Universe based SBCs possible.
- The source code of both the driver and the library has been fully developed at CERN and tested on Linux kernels up to 2.4.18
- Why not using an existing VMEbus driver instead of developing a new one?
 - We wanted to have a sufficiently generic API that could easily be implemented for any VMEbus interface on a SBC
 - Most drivers for the Universe chip lack support for some features
 - External code is not necessarily optimized for our type of applications

The Universe chip

- The API used in the `vme_rcc` package is generic enough to fit (almost) any type of VMEbus interface. So far there exists only an implementation for the Universe chip
- The Tundra Universe chip is used on most current SBCs but has a number of limitations:
 - There are only 8 map decoders for master and slave pages respectively
 - In systems with more than 8 slaves one has to use one decoder for several slaves. I.e. slaves have to be grouped -> slave base address
 - It is not possible to execute block transfers with a constant VMEbus address
 - If you are designing VMEbus slaves: Do not implement single address FIFOs for the read-out of internal memory
 - Data can be lost if a block transfer is terminated with a BERR
 - Some BERRs (posted write) are difficult to catch. The VP110 has extra logic to cope with that
 - There is no H/W byte swapping (required on little endian CPUs). The VP110 has extra logic for that purpose

vme_rcc: Overview

- The package provides:
 - A VMEbus driver
 - To be dynamically installed in the Linux kernel
 - You need the cmem_rcc and io_rcc drivers as well
 - If you are not using the standard CERN kernels you may have to compile the drivers yourself
 - A library
 - There are about 60 functions. Some details will follow
 - Utility programs
 - vmeconfig
 - cctscope
 - Dump the register of the Universe chip and some other resources of the VP110 in human readable form
 - scanvme
 - Scan the VMEbus for slave cards at unknown addresses

System initialization

- Before the first VMEbus cycle can be made one has to program (at least) one of the 8 map decodes with appropriate parameters
- This basically means mapping a range of PCI addresses (MEM space) to an equally large window of VMEbus addresses
- In many drivers this can be done dynamically at run time via a function call (but the VMEbus and PCI base addresses still have to be provided by the user)
- `vme_rcc` is different. The library cannot modify the set-up of the map decoders. This is the job of `vmeconfig`
 - Using a static set-up has the advantage that one can not run out of map decoders in the middle of an application
 - This policy enforces some discipline and is therefore not liked by everybody. We are, however, convinced that it helps to reduce problems

Address spaces

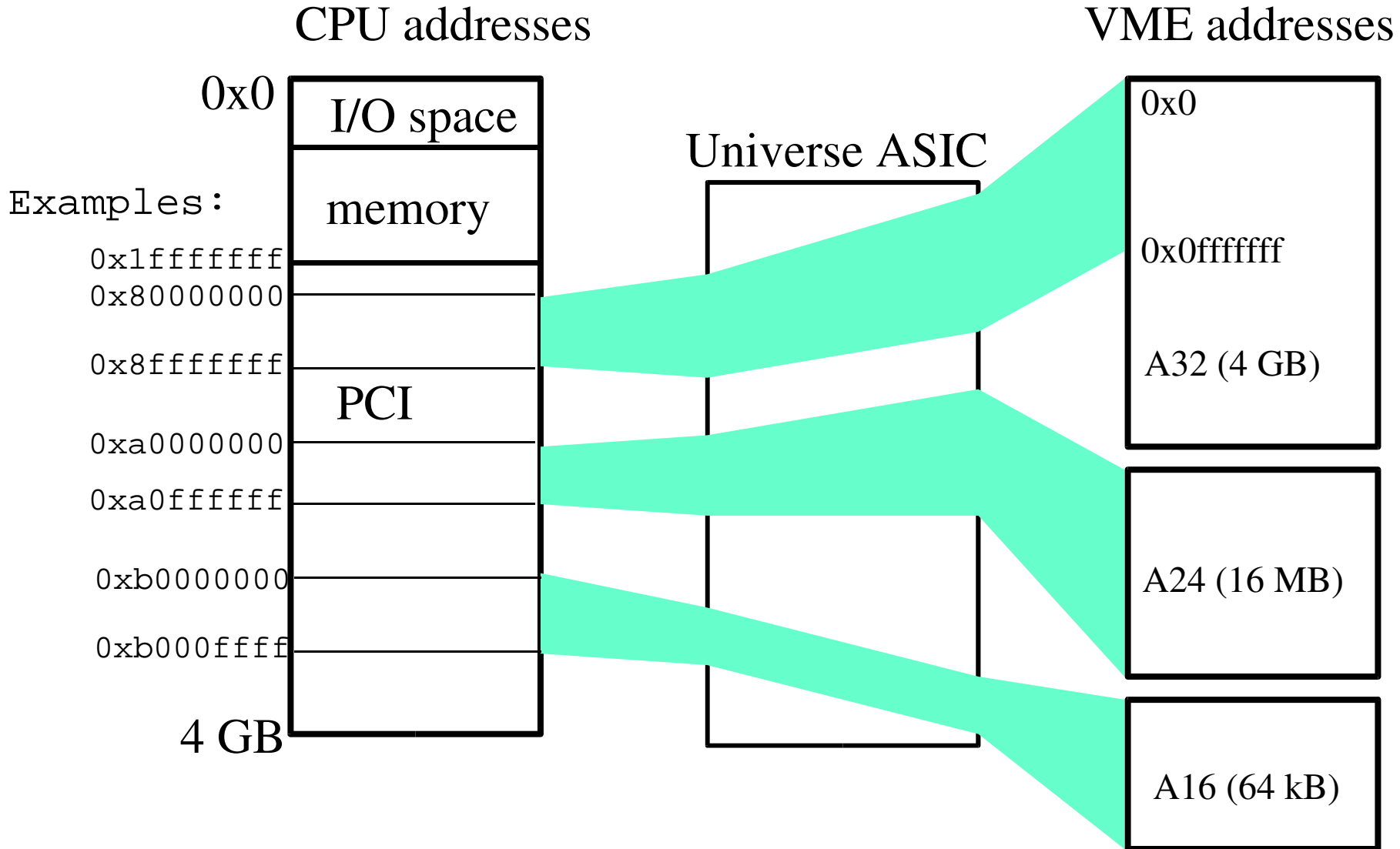

vmeconfig

- If called in the form “vmeconfig -a vmetab” it loads a user set-up into the Universe chip. This typically happens automatically at boot time
- Called as “vmeconfig -i vmetab” it allows you to edit the configuration file (vmetab)
- The configuration file is a binary. It cannot be modified with a text editor
- The (most important) user parameters are:
 - Master and slave mapping
 - Interrupts
 - Byte swapping
 - Arbitration and bus request modes
- In order to run vmeconfig you need a number of dynamic libraries from the ATLAS DF release. Use the command “ldd vmeconfig” to check
- Have a look at the on-line help in vmeconfig

vmeconfig (2)

Example: How to set up a master mapping

Use option 4 to program a map decoder. vmeconfig will ask you to enter a number of parameters:

```
Enter number of map decoder          <0..7> [0] :
Enable map decoder                    <0=no 1=yes> [1] :
Select VMEbus base address            [0x00000000] :
Select PCI base address               [0x90000000] :
Select the window size (bytes)       [0x00010000] :
Select Write posting                  <0=no 1=yes> [0] :
Select address space
  <0=A16, 1=A24, 2=A32, 5=CR/CSR, 6=USER1, 7=USER2> [0] :
Select cycle type                     <0=User, 1=Supervisor> [0] :
Select cycle type                     <0=Data, 1=Program> [0] :
```

Defining the PCI base address is the artistic part because you have to “guess” it. For an educated “guess” use these guidelines:

- DRAM addresses grow from 0x0 upwards
- PCI devices are mapped by the kernel from 0xffffffff downwards
- Addresses in the range 0x50000000 – 0xbfffffff should be safe
- “/sbin/lspci -v” may be helpful

When you are done upload the configuration into the Universe and save your changes. It is recommended to check the new set-up with cctscope (function 2/2) for errors like address overlaps



The library of the vme_rcc package

- There are four major groups of functions:
 - Single cycles
 - Block transfers
 - Interrupts
 - Service functions (including bus errors)
- Presenting all functions here would take too long. The program `vme_rcc_test.cpp` shows how the different functions are to be used
- All functions return error codes in the format defined in the `rcc_error` package
- There exists a C++ wrapper in a separate package (`RCDVme`)

A simple program doing single cycles

Let's have a look at a very simple program executing a single read cycle. For this purpose I assume that there is a VMEbus D32/A32 slave at address 0x02000000 with a total size of 4 Kb and a readable register at offset 0x80

```
#include "rcc_error/rcc_error.h"
#include "vme_rcc.h"
```

```
int main(void)
{
    VME_MasterMap_t master_map;
    volatile u_int *lptr, ldata;
    u_int ret, vbase;
    int handle;
```

```
ret = VME_Open();
if (ret != VME_SUCCESS)
{
    VME_ErrorPrint(ret);
    exit(-1);
}
```

Declare VMEbus pointers volatile to avoid problems with code optimization

Never call a function without checking for errors!!!

A simple program (2)

```
master_map.vmebus_address = 0x02000000;  
master_map.window_size = 0x1000;  
master_map.address_modifier = VME_A32;  
master_map.options = 0;  
ret = VME_MasterMap(&master_map, &handle);  
if (ret != VME_SUCCESS)  
{  
    VME_ErrorPrint(ret);  
    exit(-1);  
}
```

Create a master mapping.
Remember: Your
“vmetab” must support
these parameters

```
ret = VME_MasterMapVirtualAddress(handle, &vbase);  
if (ret != VME_SUCCESS)  
{  
    VME_ErrorPrint(ret);  
    exit(-1);  
}
```

Get the virtual address for fast access.
Alternatively you could use the safe (but
slow) functions of the API

```
lptr = (u_int *) (vbase + 0x80);
```

Cast the generic pointer to a
32-bit data type and add the
register offset

```
ldata = *lptr;
```

Execute the VMEbus cycle

A simple program (3)

```
ret = VME_MasterUnmap(handle);
  if (ret != VME_SUCCESS)
  {
    VME_ErrorPrint(ret);
    exit(-1);
  }
ret = VME_Close();
  if (ret != VME_SUCCESS)
  {
    VME_ErrorPrint(ret);
    exit(-1);
  }
}
```

Always clean up when
you're done!



Interrupts

- A VMEbus interrupt (identified by its unique 8-bit vector) can be converted by the library to either a signal or a semaphore
- It is possible to link several interrupts (of the same type) to one signal or semaphore
- It is not possible to service both RORA and ROAK interrupts on the same interrupt level
- If you are using RORA interrupts you have to re-enable the respective interrupt level after each interrupt
- Remember: before you can use an interrupt level you have to enable it with vmeconfig

```
irq_list.list_of_items[i].vector = 0x77;
irq_list.list_of_items[i].level  = 5;
irq_list.list_of_items[i].type   = VME_INT_ROAK;
signum = 42;

ret = VME_InterruptLink(&irq_list, &int_handle);
ret = VME_InterruptWait(int_handle, timeout, &ir_info);
ret = VME_InterruptRegisterSignal(int_handle, signum);
ret = VME_InterruptUnlink(int_handle);
```

Block transfers

- Block transfers can only be made to physically contiguous memory buffers (-> `cmem_rcc`). Using memory allocated by `malloc()` would technically be possible but required additional code in the driver to lock and chain the pages and there would also be a performance penalty
- Supported modes are: A24D32, A32D32 and A32D64 and “single cycle DMA”
- The VMEbus and PCI addresses have to be 8-byte aligned with respect to each other (also for D32)
- The library supports chained DMA
- Block transfers are independent of the master map decoders
- The driver can manage multiple DMA requests from several processes. It is therefore possible that a transfer does not start immediately

```
blist.list_of_items[0].vmebus_address      = 0x10000000;
blist.list_of_items[0].system_iobus_address = 0x24000000; //PCI MEM space ->CMEM_RCC
blist.list_of_items[0].size_requested      = 0x1000;
blist.list_of_items[0].control_word       = VME_DMA_D32W; //Implies A32
time_out = 100;
ret = VME_BlockTransfer(&blist, time_out);
if (ret == VME_DMAERR) {
    printf("Status:          %d\n", blist.list_of_items[0].status_word);
    printf("Bytes remaining: %d\n", blist.list_of_items[0].size_remaining);
}
```

The “odd” stuff

- vme_rcc offers support for
 - CR/CSR space read / write (only D8)
 - User defined AM codes
 - SYSFAIL interrupts
 - Interrupt generation
 - Supervisor / program AM codes
 - Constant address DMA in single cycle mode
 - Full bus error detection
- vme_rcc does not support
 - Read-Modify-Write cycles
 - Address only cycles
 - ACFAIL interrupt
 - A number of other exotic features of the Universe chip for which nobody has requested support so far

Service packages

- `cmem_rcc`
 - Driver and library for the allocation of contiguous memory (e.g. for DMA) either via the `get_free_pages()` kernel function or the `BigPhysArea` patch
 - Used by some of the test programs in the `vme_rcc` package
- `io_rcc`
 - Driver and library for the access to PCI and PC I/O registers from user code
 - Used by some of the test programs in the `vme_rcc` package
- `rcc_error`
 - A simple library for error reporting

Links for further information

- VMEbus standard
 - <http://atlas.web.cern.ch/Atlas/GROUPS/FRONTEND/VMEbus/index.html>
- Atlas S/W
 - http://atdaq-sw.cern.ch/cgi-bin/viewcvs.cgi/DAQ/DataFlow/vme_rcc/
 - <https://edms.cern.ch/document/325729/4>
 - <https://edms.cern.ch/document/349680/2>
 - <https://edms.cern.ch/document/336290/2>
 - <https://edms.cern.ch/file/325729/4/wrapper.pdf>
- Alternative VMEbus drivers for the Universe chip
 - <http://www.vmlinux.org/>
- VMEbus market overview
 - <http://www.vita.com>
- VP110 Single Board Computer
 - <http://www.gocct.com/sheets/vp11001x.htm>
- CERN Electronics Pool
 - <http://ess.web.cern.ch/ESS/electronicsPool.htm>

The End



Use of pointers to generate VMEbus cycles

```
unsigned int ui_data, *ui_ptr, virtual_address;
unsigned short us_dat, *us_ptr;
unsigned char uc_data, *uc_ptr;

Main()
{
virtual_address = Map_VME_module(physical_address, AMcode , ...); //Hypothetical function

ui_ptr = (unsigned int *) virtual_address;
us_ptr = (unsigned short *) virtual_address;
uc_ptr = (unsigned char *) virtual_address;

ui_data = *ui_ptr; //D32 read
*ui_ptr = ui_data; //D32 write
us_data = *us_ptr; //D16 read
*us_ptr = us_data; //D16 write
uc_data = *uc_ptr; //D8 read
*uc_ptr = uc_data; //D8 write

ui_data = ui_ptr[0]; // equivalent to *ui_ptr;
ui_data = ui_ptr[4]; // Read D32 at offset 0x10 (4 * 4 bytes)
uc_data = uc_ptr[4]; // Read D8 at offset 0x4 (4 * 1 byte)
}
```



Signal handling

```
#include <signal.h>
//Prototypes
void SigBusHandler(int signum);

main
{
    struct sigaction sa2;

    sigemptyset(&sa2.sa_mask);
    sa2.sa_flags = 0;
    sa2.sa_handler = SigBusHandler;
    stat = sigaction(SIGBUS, &sa2, NULL);
    if (stat < 0)
    {
        printf("Cannot install SIGBUS handler (error=%d)\n", stat);
        exit(-1);
    }
}

void SigBusHandler(int signum)
{
    printf("Bus error received\n");
}
```

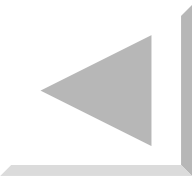

Managing drivers

- Is my driver loaded?
 - `/sbin/lsmmod`
- In what state is my driver?
 - `more /proc/<name>` (value of name depends on the driver used.
ATLAS: “vme_rcc”, “cmem_rcc” or “io_rcc”)
- Is the driver currently used
 - `/sbin/lsmmod`
 - Check the “Used by” number in the third column.
- How to restart a driver
 - “Used by” has to be 0
 - `su` (then enter root password)
 - `cd /etc/rc.d/init.d`
 - `<name> restart` (e.g. “vme_rcc restart”)



(Common) VMEbus AM codes

AM code	Description
0x08	A32, user, 64-bit (MBLT) block transfer
0x09	A32, user, data, single cycle
0x0A	A32, user, program, single cycle
0x0B	A32, user, 32-bit (BLT) block transfer
0x0C	A32, supervisor, 64-bit (MBLT) block transfer
0x0D	A32, supervisor, data, single cycle
0x0E	A32, supervisor, program, single cycle
0x0F	A32, supervisor, 32-bit (BLT) block transfer
0x29	A16, user, data, single cycle
0x2C	A16, supervisor, data, single cycle
0x2F	CR/CSR single cycle (geographical addressing)
0x38	A24, user, 64-bit (MBLT) block transfer
0x39	A24, user, data, single cycle
0x3A	A24, user, program, single cycle
0x3B	A24, user, 32-bit (BLT) block transfer
0x3C	A24, supervisor, 64-bit (MBLT) block transfer
0x3D	A24, supervisor, data, single cycle
0x3E	A24, supervisor, program, single cycle
0x3F	A24, supervisor, 32-bit (BLT) block transfer

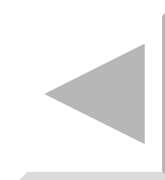

Other information

- For the ATLAS VMEbus library there is a C++ wrapper
 - <https://edms.cern.ch/file/325729/4/wrapper.pdf>



Glossary

- ACFAIL:** A line on the VMEbus backplane driven by the power supply. If asserted the +5V power will be available for at least an other 4 ms and then drop below 4.875 V
- BBSY:** The protocol line that indicates if the bus is being used (Bus Busy)
- BERR:** The protocol line that signals a bus error
- BG0..3:** Protocol lines used by the arbiter to grant the bus to a master
- BR0..3:** Protocol lines used by masters to request the bus
- CR/CSR:** Configuration ROM / Control and Status Registers, a feature of VME64(x) slave cards for the plug-and-play configuration of the on-board functions
- Daisy chain:** Some of the signal lines of a VMEbus backplane are not bussed but connect only two adjacent slots. In order to pass a signal from slot N to slot N+m the VMEbus modules in between these slots have to pass the signal from the input side to the output side. In case of an empty slot the connection has to be made mechanically (jumper) or automatic (special backplane)
- DMA:** Direct Memory Access (block transfers)
- EMC:** ElectroMagnetic Compatibility:
- IACK:** Protocol line used for the interrupt handshake
- J0, J1, J2, J3:** The female jacks (connectors) on the VMEbus backplane
- Jaux:** A special connector sitting between J1 and J2 on some backplanes used at CERN. Required for certain front-end modules but incompatible with the P0 connector of VME64x
- P0, P1, P2, P3:** The male plugs on VMEbus cards connecting to the backplane
- ROAK:** Release On AKnowledge, A type of VMEbus interrupter that clears the interrupt in response to the IACK cycle
- RORA:** Release On Register Access, A type of VMEbus interrupter that requires a special intervention from the master to clear an interrupt
- SBC:** Single Board Computer
- SYSFAIL:** A VMEbus line that indicates a problem with one card. SYSFAIL can be monitored e.g. by an SBC where it would be converted to an interrupt
- Write Posting:** A way of speeding up single write cycles. The PCI cycle gets acknowledged before the VMEbus cycle completes. This decoupling of the busses increases the speed but can complicate the detection of bus errors

The Tundra Universe II ASIC

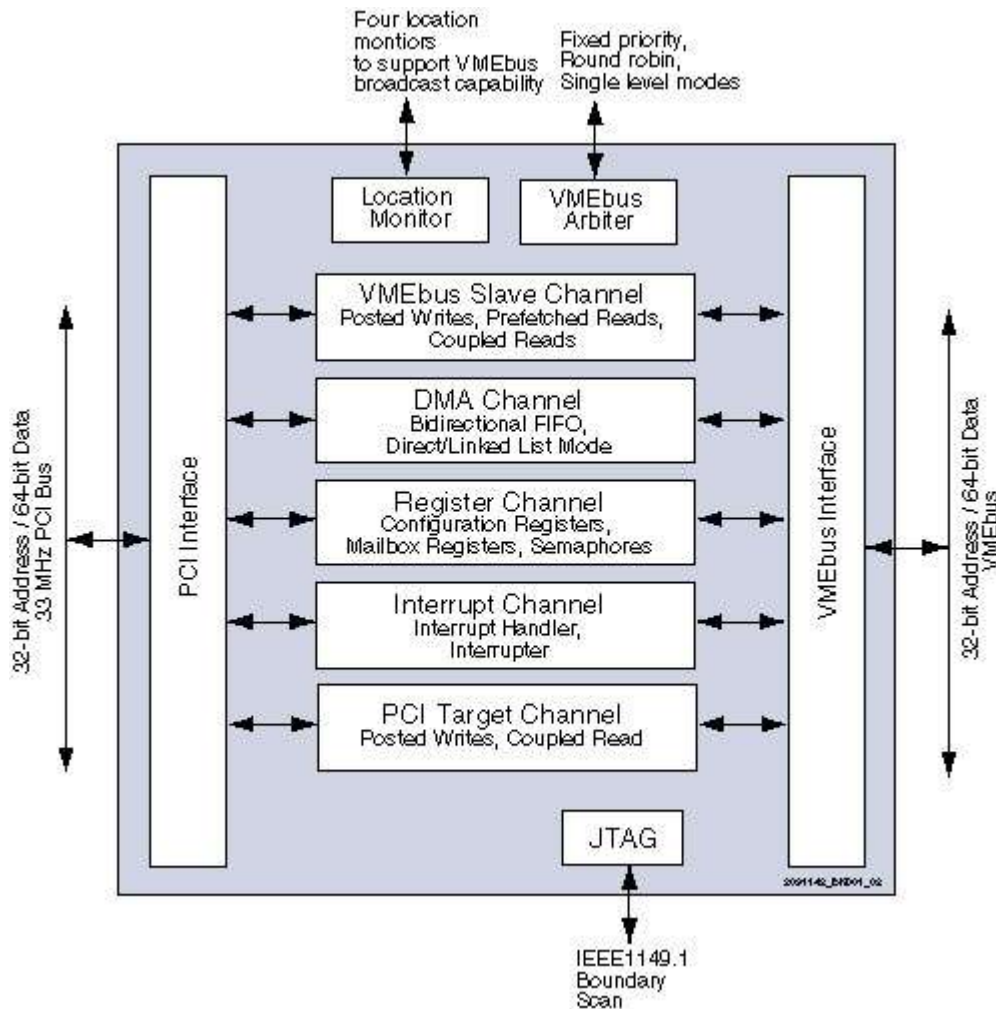

- Bridges VMEbus to PCI
- Used on most of the commercially available VMEbus processors

