

UNISTRUT®

Price Catalog – UC-139

Effective August 3, 2009

- Channels & Closure Strips
- Fittings & Accessories
- Nuts & Hardware
- Electrical Raceway Components
- Cush-A-Clamps®
- Concrete Inserts
- Telestrut®
- PrimeAngle™

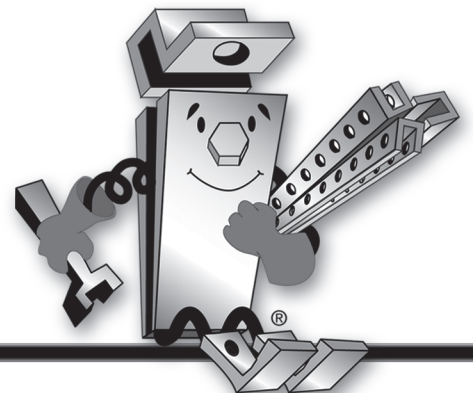

Table of Contents

Section 1 - 1 ⁵ / ₈ " Channel Width Series	4 - 11
Section 2 - Channel Nuts & Hardware.	12 - 14
Section 3 - 1 ⁵ / ₈ " General Fittings and Accessories	15 - 33
Section 4 - Pipe, Conduit and Tubing Clamps	34 - 41
Section 5 - Electrical Raceway Fittings and Accessories	42 - 44
Section 6 - Concrete Inserts	45 - 47
Section 7 - 1 ¹ / ₄ " Channel Width Series and Accessories	48 - 51
Section 8 - 1 ³ / ₁₆ " Channel Width Series and Accessories	52 - 55
Section 9 - Telestrut® Telescoping Strut and Accessories	56
Section 10 - PrimeAngle™	57
Standard Terms and Conditions	58 - 59

Please contact us for pricing of Fiberglass products.

<i>Product Codes</i>		
A	1 ⁵ / ₈ " & 1 ³ / ₁₆ " Channel Width Series	
B	Pipe, Conduit and Tubing Clamps	
C	Channel Nuts & Hardware	
D	1 ⁵ / ₈ " & 1 ³ / ₁₆ " General Fittings and Accessories	
E	Threaded Rod	
F	Concrete Inserts	
G	Cush-A-Clamps®	
H	PrimeAngle™	
I	1 ¹ / ₄ " Channel Width Series	
J	1 ¹ / ₄ " Fittings and Accessories	
T	Telestrut® Telescoping Strut and Accessories	

TRADE CUSTOMS

- 1 The prices shown on the following pages refer to all parts as detailed in our General Engineering Catalog.
- 2 When materials are ordered without the finish being specified, it will be understood that standard finish is desired.
- 3 Prices of "P" number parts do not include any bolts or UNISTRUT nuts, except where specifically called for on the detail of the "P" number parts or in the case of all pipe clamps where the screw and nut are shown and not specifically exempted.
- 4 Part numbers having a suffix of "S" indicate that a 1 1/2" or 2" set screw has been included in the price.
- 5 Prices will be quoted on all special factory fabricated material or apparatus on application.
- 6 All prices are subject to change without notice.

UNISTRUT CORPORATION, Manufacturers of METAL FRAMING AND ACCESSORIES, TELESCOPING TUBING, SOLID AND PERFORATED TELESTRUT® TELESCOPIC STRUT, TUBING SIGN SUPPORT SYSTEM.

Marketing throughout the world by Unistrut:

Tel: (800) 521-7730 • www.unistrut.com

Products of UNISTRUT are manufactured under one or more of the following United States patents:

3,362,738	3,388,809	3,415,554	3,417,951	3,421,280	3,437,779
3,443,348	3,468,567	3,601,347	3,617,076	3,618,882	3,628,296
3,721,463	3,861,107	3,877,275	3,888,440	3,888,441	3,914,063
3,927,499	3,928,930	3,948,012	3,968,624	3,994,111	4,073,114
4,277,923	4,278,288	4,289,415			

Foreign patents and other patents pending

Registered Trademarks of UNISTRUT Corporation:
 "UNISTRUT", "P 1000", "TELESPAR", "TELESTRUT", "UNI-CLIP",
 "UNICUSHION", "GRAB BAG", and the cartoon character "Mr. Strut".

©2006, Unistrut Corporation Printed in U.S.A.

Suggested Price Schedule July 1, 2002

GENERAL SPECIFICATIONS

FRAMING MEMBERS - UNISTRUT channels and continuous inserts are accurately and carefully cold formed to size from low carbon strip steel. One side of the channel has a continuous slot with inturned lips. Secure attachments may be made to the framing member with the use of hardened, toothed, slotted nuts which engage the inturned lips.

Steel material shall conform to the following ASTM specifications:

GAUGE	FINISH	ASTM NO.
12	GR&HG	A1011 SS GR 33
	PG	A446 GR A
14	GR&HG	A1011 SS GR 33
	PG	A446 GR A
16	GR&HG	A1011 SS GR 33
	PG	A446 GR A
19	GR	A366

FITTINGS - The UNISTRUT fittings, unless noted otherwise, are punch press made from hot rolled, pickled and oiled steel plates or strip and conform to ASTM specification A575 and A576. The fitting steel also meets the physical requirements of A570 GR 33. The pickling of the steel

produces a smooth surface free from scale.

NUTS AND SCREWS - The UNISTRUT nuts are made from steel bars and after all machining operations are completed, they are thoroughly case hardened. They are rectangular with the ends so shaped as to permit a quarter turn crosswise in the framing member after inserting through the slotted opening in the channel and prevent any further turning of the nut. Two toothed grooves in the top of the nut engage the inturned lips of the channel and, after bolting operations are completed, will prevent any longitudinal movement of the bolt and nut within the framing member. All bolts and nuts have Unified and American coarse screw threads. The standard framing nut is 1/2" and conforms to ASTM Specification A576 GR 1015 (material only). Screws conform to SAE J429 GR 2 (also meets and exceeds ASTM A307).

FINISHES

PERMA-GREEN (GR)—Channel and parts are carefully cleaned and phosphated. Immediately after phosphating, a uniform coat of a highly effective rust inhibiting acrylic enamel paint is applied by electro-deposition and thoroughly baked. Color is PERMA-GREEN per Federal Standard 595a color number 14109 (dark limit V-). The resulting finish will withstand 400 hours salt spray when tested in accordance with ASTM designation B-117.

ELECTRO-GALVANIZED (EG)—Parts, screws and nuts are coated with zinc electrolytically to commercial standards. (ASTM-B633 Type III SC1).

PLAIN (PL)—Plain finish on the UNISTRUT channel has the oiled surface just as the channel comes from the rolling mill, and the fittings have an oiled surface from the original oiled surface of the bar stock material.

PRE-GALVANIZED CHANNEL (PG)—Material (steel strip) is coated with zinc by hot-dipped process prior to roll forming or press operations. The zinc weight coating is G90 conforming to ASTM Specification ASTM-A653.

HOT-DIPPED GALVANIZED (HG)—Material is coated with zinc after being roll formed or after all manufacturing operations are completed, conforming to ASTM Specification No. A-123 or A-153.

SPECIAL COATING—When specific applications require other commercially available finishes they can be supplied per specification.

WEIGHTS AND DIMENSIONS

Weights given for all materials are approximate shipping weights. All dimensions subject to commercial tolerance variations.

A STATEMENT OF QUALITY

UNISTRUT'S growth and leadership in the metal framing industry has been a direct result of developing and maintaining high standards of product control in manufacturing, finishing and installation. The design criteria and testing is based on industry codes and standards.

UNISTRUT'S Quality Assurance Program has been audited and approved by members of the power generating industry.

WE RESERVE THE RIGHT TO MAKE SPECIFICATION CHANGES WITHOUT NOTICE IN THE INTEREST OF IMPROVING OUR PRODUCT.

Section 11 STANDARD CONDITIONS FOR SALE OF GOODS AND/OR SERVICES

1. ACCEPTANCE, MODIFICATIONS AND CANCELLATIONS:

Representatives of Unistrut Corporation ("Unistrut" or "Seller") are not authorized to make offers to sell products or services. (Hereinafter the word Products is deemed to include services where applicable and both or either are referred to as Products.) Written quotations, which are invitations for the purchaser to submit an offer per the quotation,

Part No.	Fin.	Size	Wt/100	Std Qty	\$/100	UM
A 		1-5/8" x 1-5/8", 12 Gage, Solid				
P1000 10	GR	10 ft. len.	190.00	500	\$675.00	Ft
P1000 10	PG	10 ft. len.	190.00	500	\$716.90	Ft
P1000 10	HG	10 ft. len.	201.40	500	\$1,055.20	Ft
P1000 10	ZD	10 ft. len.	190.00	500	\$716.90	Ft
P1000 10	PL	10 ft. len.	190.00	500	\$623.95	Ft
P1000 10	EA	10 ft. len.	73.30	500	CALL	Ft
P1000 10	SS	10 ft. len.	190.00	500	CALL	Ft
P1000 10	ST	10 ft. len.	190.00	500	CALL	Ft
P1000 20	GR	20 ft. len.	190.00	1000	\$675.00	Ft
P1000 20	PG	20 ft. len.	190.00	1000	\$716.90	Ft
P1000 20	HG	20 ft. len.	201.40	1000	\$1,055.20	Ft
P1000 20	ZD	20 ft. len.	190.00	1000	\$716.90	Ft
P1000 20	PL	20 ft. len.	190.00	1000	\$623.95	Ft
P1000 20	EA	20 ft. len.	73.30	1000	CALL	Ft
P1000 20	SS	20 ft. len.	190.00	1000	CALL	Ft
P1000 20	ST	20 ft. len.	190.00	1000	CALL	Ft

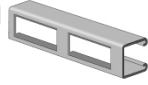
Part No.	Fin.	Size	Wt/100	Std Qty	\$/100	UM
A 		1-5/8" x 1-5/8", 12 Gage; with Double Slots				
P1000DS 10	GR	10 ft. len.	173.00	500	\$899.75	Ft
P1000DS 10	PG	10 ft. len.	173.00	500	\$937.15	Ft
P1000DS 10	HG	10 ft. len.	183.40	500	\$1,190.45	Ft
P1000DS 10	PL	10 ft. len.	173.00	500	\$804.80	Ft
P1000DS 20	GR	20 ft. len.	173.00	1000	\$899.75	Ft
P1000DS 20	PG	20 ft. len.	173.00	1000	\$937.15	Ft
P1000DS 20	PL	20 ft. len.	173.00	1000	\$804.80	Ft

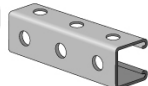
Part No.	Fin.	Size	Wt/100	Std Qty	\$/100	UM
A 		1-5/8" x 1-5/8", 12 Gage; Round Holes on all three sides				
P1000H3 10	GR	10 ft. len.	175.00	500	\$815.20	Ft
P1000H3 10	PG	10 ft. len.	175.00	500	\$849.25	Ft
P1000H3 10	HG	10 ft. len.	185.00	500	\$1,077.40	Ft
P1000H3 10	PL	10 ft. len.	175.00	500	\$689.65	Ft
P1000H3 20	GR	20 ft. len.	175.00	1000	\$815.20	Ft
P1000H3 20	PG	20 ft. len.	175.00	1000	\$849.25	Ft
P1000H3 20	HG	20 ft. len.	185.00	1000	\$1,077.40	Ft
P1000H3 20	PL	20 ft. len.	175.00	1000	\$689.65	Ft

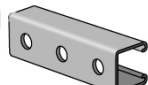
Part No.	Fin.	Size	Wt/100	Std Qty	\$/100	UM
A 		1-5/8" x 1-5/8", 12 Gage; Round Holes				
P1000HS 10	GR	10 ft. len.	185.00	500	\$804.00	Ft
P1000HS 10	PG	10 ft. len.	185.00	500	\$837.40	Ft
P1000HS 10	HG	10 ft. len.	196.10	500	\$1,130.40	Ft
P1000HS 10	ZD	10 ft. len.	185.00	500	\$837.40	Ft
P1000HS 10	PL	10 ft. len.	185.00	500	\$724.20	Ft
P1000HS 10	EA	10 ft. len.	76.00	100	CALL	Ft
P1000HS 10	SS	10 ft. len.	185.00	500	CALL	Ft
P1000HS 20	GR	20 ft. len.	185.00	1000	\$804.00	Ft
P1000HS 20	PG	20 ft. len.	185.00	1000	\$837.40	Ft
P1000HS 20	HG	20 ft. len.	196.10	1000	\$1,130.40	Ft
P1000HS 20	PL	20 ft. len.	185.00	1000	\$724.20	Ft
P1000HS 20	EA	20 ft. len.	76.00	1000	CALL	Ft
P1000HS 20	SS	20 ft. len.	185.00	1000	CALL	Ft

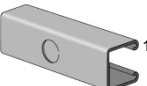
Part No.	Fin.	Size	Wt/100	Std Qty	\$/100	UM
A 		1-5/8" x 1-5/8", 12 Gage; Knock Outs				
P1000KO 10	GR	10 ft. len.	190.00	500	\$815.20	Ft
P1000KO 10	PG	10 ft. len.	190.00	500	\$849.25	Ft
P1000KO 10	HG	10 ft. len.	201.40	500	\$1,157.20	Ft
P1000KO 10	PL	10 ft. len.	190.00	500	\$734.70	Ft
P1000KO 20	GR	20 ft. len.	190.00	1000	\$815.20	Ft
P1000KO 20	PG	20 ft. len.	190.00	1000	\$849.25	Ft
P1000KO 20	PL	20 ft. len.	190.00	1000	\$734.70	Ft

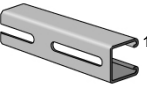
Part No.	Fin.	Size	Wt/100	Std Qty	\$/100	UM
A 		1-5/8" x 1-5/8", 12 Gage; Long Slots				
P1000SL 10	GR	10 ft. len.	180.00	500	\$804.00	Ft
P1000SL 10	PG	10 ft. len.	180.00	500	\$837.40	Ft
P1000SL 10	HG	10 ft. len.	190.80	500	\$1,119.45	Ft
P1000SL 10	ZD	10 ft. len.	180.00	500	\$837.40	Ft
P1000SL 10	PL	10 ft. len.	180.00	500	\$724.20	Ft
P1000SL 10	SS	10 ft. len.	188.00	500	CALL	Ft
P1000SL 20	GR	20 ft. len.	180.00	1000	\$804.00	Ft
P1000SL 20	PG	20 ft. len.	180.00	1000	\$837.40	Ft
P1000SL 20	HG	20 ft. len.	190.80	1000	\$1,119.45	Ft
P1000SL 20	PL	20 ft. len.	180.00	1000	\$724.20	Ft
P1000SL 20	EA	20 ft. len.	74.00	500	CALL	Ft
P1000SL 20	SS	20 ft. len.	180.00	1000	CALL	Ft

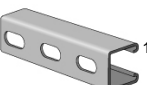
Part No.	Fin.	Size	Wt/100	Std Qty	\$/100	UM
A 		1-5/8" x 1-5/8", 12 Gage; Slotted				
P1000T 10	GR	10 ft. len.	185.00	500	\$788.85	Ft
P1000T 10	PG	10 ft. len.	185.00	500	\$807.90	Ft
P1000T 10	HG	10 ft. len.	196.10	500	\$1,109.70	Ft
P1000T 10	ZD	10 ft. len.	185.00	500	\$807.90	Ft
P1000T 10	PL	10 ft. len.	185.00	500	\$710.65	Ft
P1000T 10	EA	10 ft. len.	76.00	500	CALL	Ft
P1000T 10	SS	10 ft. len.	188.00	500	CALL	Ft
P1000T 20	GR	20 ft. len.	185.00	1000	\$788.85	Ft
P1000T 20	PG	20 ft. len.	185.00	1000	\$807.90	Ft
P1000T 20	HG	20 ft. len.	196.10	1000	\$1,109.70	Ft
P1000T 20	ZD	20 ft. len.	185.00	1000	\$807.90	Ft
P1000T 20	PL	20 ft. len.	185.00	1000	\$710.65	Ft
P1000T 20	EA	20 ft. len.	76.00	500	CALL	Ft
P1000T 20	SS	20 ft. len.	185.00	1000	CALL	Ft
P1000T 20	ST	20 ft. len.	185.00	1000	CALL	Ft

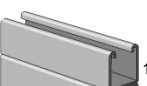
Part No.	Fin.	Size	Wt/100	Std Qty	\$/100	UM
A 		1-5/8" x 3-1/4", 12 Gage Back-to-Back, Solid				
P1001 10	GR	10 ft. len.	380.00	250	\$1,570.10	Ft
P1001 10	PG	10 ft. len.	380.00	250	\$1,629.00	Ft
P1001 10	HG	10 ft. len.	402.80	250	\$2,253.30	Ft
P1001 10	ZD	10 ft. len.	380.00	500	\$1,629.00	Ft
P1001 10	PL	10 ft. len.	380.00	250	\$1,407.70	Ft
P1001 10	EA	10 ft. len.	134.00	250	CALL	Ft
P1001 10	SS	10 ft. len.	380.00	500	CALL	Ft
P1001 10	ST	10 ft. len.	380.00	500	CALL	Ft
P1001 20	GR	20 ft. len.	380.00	500	\$1,570.10	Ft
P1001 20	PG	20 ft. len.	380.00	500	\$1,629.00	Ft
P1001 20	HG	20 ft. len.	402.80	500	\$2,253.30	Ft
P1001 20	ZD	20 ft. len.	380.00	500	\$1,629.00	Ft
P1001 20	PL	20 ft. len.	380.00	500	\$1,407.70	Ft
P1001 20	EA	20 ft. len.	134.00	500	CALL	Ft
P1001 20	SS	20 ft. len.	380.00	500	CALL	Ft
P1001 20	ST	20 ft. len.	380.00	500	CALL	Ft

AL-Alum.; CP-Cadmium Plated; EA- Extruded Alum.; EG-Electro-Galv.; EV-Everdur; FG-Fiberglass Reinforced Polyester; GR-Perma-Green; GY-Gray; HG-Hot Dip Galv.; MA-Maple; WH-White; NC-No Closure Strip; W/End Caps and Back Plates; PL-Plain; PG-Pre-Galv.; PO-Porcelain; SS-Stainless 304; ST-Stainless 316; WC-W/Closure Strip, End Caps and Back Plates; X-No Closure Strip or End Caps, W/Back Plates; ZD-Yellow Zinc Dichromate
 Note: For part details and loading information refer to the current Unistrut General Engineering Catalog.

Part No. Fin. Size W/100 Std Qty \$/100 UM

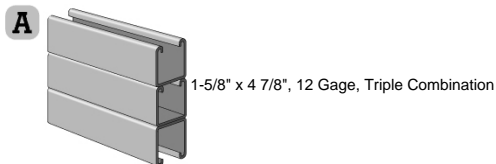

P1001-3 10	PG	10 ft. len.	570.00	10	\$4,704.45	Ft
P1001-3 10	PL	10 ft. len.	570.00	10	\$3,611.00	Ft
P1001-3 20	GR	20 ft. len.	570.00	20	\$3,856.10	Ft
P1001-3 20	PG	20 ft. len.	570.00	20	\$4,704.45	Ft
P1001-3 20	PL	20 ft. len.	570.00	20	\$3,611.00	Ft

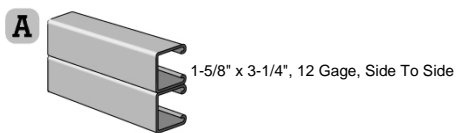

P1001A 10	GR	10 ft. len.	380.00	160	\$1,692.90	Ft
P1001A 10	PG	10 ft. len.	380.00	160	\$1,859.20	Ft
P1001A 10	HG	10 ft. len.	402.80	160	\$2,384.95	Ft
P1001A 10	PL	10 ft. len.	380.00	160	\$1,529.80	Ft
P1001A 20	GR	20 ft. len.	380.00	320	\$1,692.90	Ft
P1001A 20	PG	20 ft. len.	380.00	320	\$1,859.20	Ft
P1001A 20	HG	20 ft. len.	402.80	320	\$2,384.95	Ft
P1001A 20	PL	20 ft. len.	380.00	320	\$1,529.80	Ft

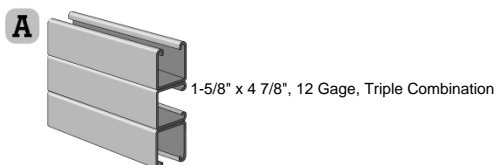

P1001A3 10	GR	10 ft. len.	570.00	10	\$2,649.90	Ft
P1001A3 10	PG	10 ft. len.	570.00	10	\$2,976.90	Ft
P1001A3 10	HG	10 ft. len.	604.20	10	\$3,686.65	Ft
P1001A3 10	PL	10 ft. len.	570.00	10	\$2,404.15	Ft
P1001A3 20	GR	20 ft. len.	570.00	20	\$2,649.90	Ft
P1001A3 20	PG	20 ft. len.	570.00	20	\$2,976.90	Ft
P1001A3 20	HG	20 ft. len.	604.20	20	\$3,686.65	Ft
P1001A3 20	PL	20 ft. len.	570.00	20	\$2,404.15	Ft

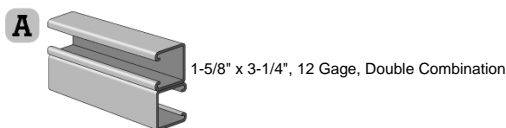

P1001B 10	GR	10 ft. len.	380.00	160	\$1,692.90	Ft
P1001B 10	PG	10 ft. len.	380.00	160	\$1,859.20	Ft
P1001B 10	HG	10 ft. len.	402.80	160	\$2,384.95	Ft
P1001B 10	PL	10 ft. len.	380.00	160	\$1,529.80	Ft
P1001B 20	GR	20 ft. len.	380.00	320	\$1,692.90	Ft
P1001B 20	PG	20 ft. len.	380.00	320	\$1,859.20	Ft
P1001B 20	HG	20 ft. len.	402.80	320	\$2,384.95	Ft
P1001B 20	PL	20 ft. len.	380.00	320	\$1,529.80	Ft

Part No. Fin. Size W/100 Std Qty \$/100 UM

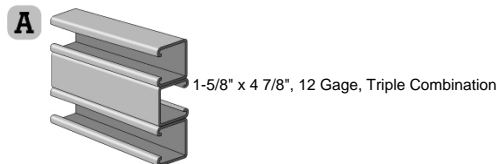

P1001B3 10	GR	10 ft. len.	570.00	10	\$2,649.90	Ft
P1001B3 10	PG	10 ft. len.	570.00	10	\$2,976.90	Ft
P1001B3 10	PL	10 ft. len.	570.00	10	\$2,404.15	Ft
P1001B3 20	GR	20 ft. len.	570.00	20	\$2,649.90	Ft
P1001B3 20	PG	20 ft. len.	570.00	20	\$2,976.90	Ft
P1001B3 20	HG	20 ft. len.	604.20	20	\$3,686.65	Ft
P1001B3 20	PL	20 ft. len.	570.00	20	\$2,404.15	Ft

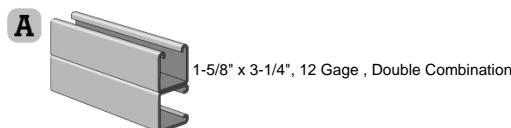

P1001C 10	GR	10 ft. len.	380.00	160	\$1,692.90	Ft
P1001C 10	PG	10 ft. len.	380.00	160	\$1,859.20	Ft
P1001C 10	HG	10 ft. len.	402.80	160	\$2,384.95	Ft
P1001C 10	PL	10 ft. len.	380.00	160	\$1,529.80	Ft
P1001C 20	GR	20 ft. len.	380.00	320	\$1,692.90	Ft
P1001C 20	PG	20 ft. len.	380.00	320	\$1,859.20	Ft
P1001C 20	HG	20 ft. len.	402.80	320	\$2,384.95	Ft
P1001C 20	PL	20 ft. len.	380.00	320	\$1,529.80	Ft
P1001C 20	SS	20 ft. len.	380.00	320	CALL	Ft

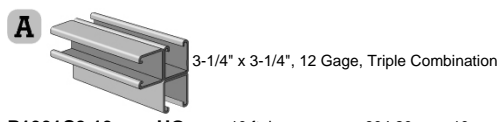

P1001C3 10	HG	10 ft. len.	604.20	10	\$5,237.95	Ft
P1001C3 10	PL	10 ft. len.	570.00	10	\$3,268.05	Ft
P1001C3 20	PG	20 ft. len.	570.00	20	\$4,189.55	Ft
P1001C3 20	HG	20 ft. len.	604.20	20	\$5,237.95	Ft
P1001C3 20	PL	20 ft. len.	570.00	20	\$3,268.05	Ft

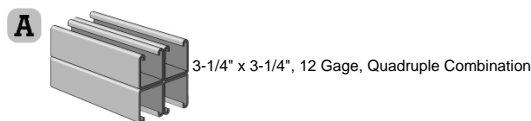

P1001C41 10	GR	10 ft. len.	760.00	10	\$3,825.80	Ft
P1001C41 10	PG	10 ft. len.	760.00	10	\$4,868.80	Ft
P1001C41 10	HG	10 ft. len.	805.60	10	\$5,209.15	Ft
P1001C41 10	PL	10 ft. len.	760.00	10	\$3,498.15	Ft
P1001C41 20	GR	20 ft. len.	760.00	20	\$3,825.80	Ft
P1001C41 20	PG	20 ft. len.	760.00	20	\$4,868.80	Ft
P1001C41 20	HG	20 ft. len.	805.60	20	\$5,209.15	Ft
P1001C41 20	PL	20 ft. len.	760.00	20	\$3,498.15	Ft

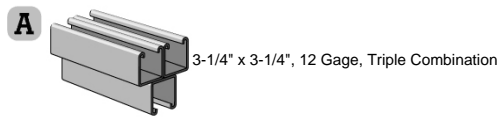

P1001D3 20	GR	20 ft. len.	570.00	20	\$2,869.70	Ft
P1001D3 20	PG	20 ft. len.	570.00	20	\$3,959.35	Ft
P1001D3 20	HG	20 ft. len.	604.20	20	\$4,947.80	Ft
P1001D3 20	PL	20 ft. len.	570.00	20	\$2,623.10	Ft

AL-Alum.; CP-Cadmium Plated; EA- Extruded Alum.; EG-Electro-Galv.; EV-Everdur; FG-Fiberglass Reinforced Polyester; GR-Perma-Green; GY-Gray; HG-Hot Dip Galv.; MA-Maple; WH-White; NC-No Closure Strip; W/End Caps and Back Plates; PL-Plain; PG-Pre-Galv.; PO-Porcelain; SS-Stainless 304; ST-Stainless 316; WC-W/Closure Strip, End Caps and Back Plates; X-No Closure Strip or End Caps, W/Back Plates; ZD-Yellow Zinc Dichromate
 Note: For part details and loading information refer to the current Unistrut General Engineering Catalog.

Part No. Fin. Size Wt/100 Std Qty \$/100 UM

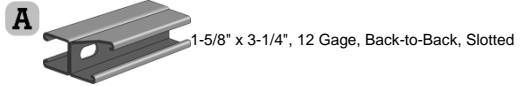

P1001T 10	GR	10 ft. len.	370.00	250	\$2,085.45	Ft
P1001T 10	PG	10 ft. len.	370.00	250	\$2,318.20	Ft
P1001T 10	HG	10 ft. len.	392.00	250	\$2,536.40	Ft
P1001T 10	PL	10 ft. len.	370.00	250	\$1,803.75	Ft
P1001T 20	GR	20 ft. len.	370.00	500	\$2,085.45	Ft
P1001T 20	PG	20 ft. len.	370.00	500	\$2,318.20	Ft
P1001T 20	HG	20 ft. len.	392.20	500	\$2,536.40	Ft
P1001T 20	ZD	20 ft. len.	370.00	500	\$2,318.20	Ft
P1001T 20	PL	20 ft. len.	370.00	500	\$1,803.75	Ft

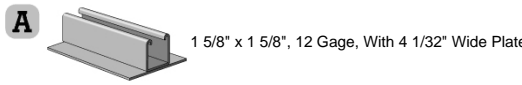

P1003 10	GR	10 ft. len.	335.00	10	\$1,968.25	Ft
P1003 10	PG	10 ft. len.	335.00	10	\$3,053.70	Ft
P1003 10	PL	10 ft. len.	335.00	10	\$1,766.90	Ft
P1003 20	GR	20 ft. len.	335.00	20	\$1,850.65	Ft
P1003 20	PG	20 ft. len.	335.00	20	\$3,053.70	Ft
P1003 20	PL	20 ft. len.	335.00	20	\$1,728.70	Ft

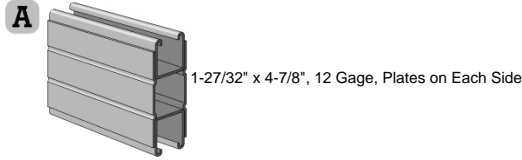

P1004A 10	GR	10 ft. len.	670.00	10	\$5,240.80	Ft
P1004A 10	PG	10 ft. len.	670.00	10	\$5,904.80	Ft
P1004A 10	HG	10 ft. len.	710.20	10	\$6,539.25	Ft
P1004A 10	PL	10 ft. len.	670.00	10	\$4,832.50	Ft
P1004A 20	GR	20 ft. len.	670.00	20	\$5,240.80	Ft
P1004A 20	HG	20 ft. len.	710.20	20	\$6,539.25	Ft
P1004A 20	PL	20 ft. len.	670.00	20	\$4,832.50	Ft

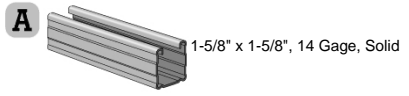

P1100 10	GR	10 ft. len.	142.00	500	\$620.35	Ft
P1100 10	PG	10 ft. len.	142.00	500	\$637.00	Ft
P1100 10	HG	10 ft. len.	148.40	500	\$873.05	Ft
P1100 10	ZD	10 ft. len.	142.00	500	\$637.00	Ft
P1100 10	PL	10 ft. len.	142.00	500	\$542.50	Ft
P1100 10	SS	10 ft. len.	142.00	500	CALL	Ft
P1100 20	GR	20 ft. len.	142.00	1000	\$620.35	Ft
P1100 20	PG	20 ft. len.	142.00	1000	\$637.00	Ft
P1100 20	HG	20 ft. len.	148.40	1000	\$873.05	Ft
P1100 20	PL	20 ft. len.	142.00	1000	\$542.50	Ft
P1100 20	SS	20 ft. len.	142.00	1000	CALL	Ft

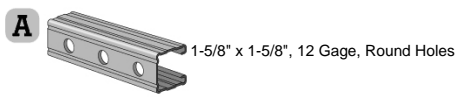

P1100HS 10	GR	10 ft. len.	136.00	500	\$724.75	Ft
P1100HS 10	PG	10 ft. len.	136.00	500	\$751.20	Ft
P1100HS 10	PL	10 ft. len.	136.00	500	\$645.20	Ft
P1100HS 20	GR	20 ft. len.	136.00	1000	\$724.75	Ft
P1100HS 20	PG	20 ft. len.	136.00	1000	\$751.20	Ft
P1100HS 20	PL	20 ft. len.	136.00	1000	\$645.20	Ft
P1100HS 20	SS	20 ft. len.	136.00	1000	CALL	Ft

Part No. Fin. Size Wt/100 Std Qty \$/100 UM

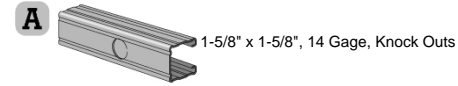

P1100KO 10	PG	10 ft. len.	140.00	500	\$761.85	Ft
-------------------	-----------	-------------	--------	-----	-----------------	----

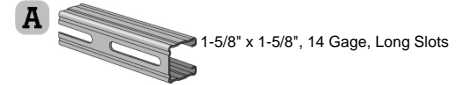

P1100SL 10	GR	10 ft. len.	136.00	500	\$705.45	Ft
P1100SL 10	PG	10 ft. len.	136.00	500	\$730.10	Ft
P1100SL 10	PL	10 ft. len.	136.00	500	\$627.95	Ft
P1100SL 20	GR	20 ft. len.	136.00	1000	\$705.45	Ft
P1100SL 20	PG	20 ft. len.	136.00	1000	\$730.10	Ft
P1100SL 20	PL	20 ft. len.	136.00	1000	\$627.95	Ft



P1100T 10	GR	10 ft. len.	136.00	500	\$692.30	Ft
P1100T 10	PG	10 ft. len.	136.00	500	\$718.55	Ft
P1100T 10	HG	10 ft. len.	144.20	500	\$909.35	Ft
P1100T 10	ZD	10 ft. len.	136.00	500	\$718.55	Ft
P1100T 10	PL	10 ft. len.	136.00	500	\$616.30	Ft
P1100T 10	SS	10 ft. len.	136.00	500	CALL	Ft
P1100T 20	GR	20 ft. len.	136.00	1000	\$692.30	Ft
P1100T 20	PG	20 ft. len.	136.00	1000	\$718.55	Ft
P1100T 20	PL	20 ft. len.	136.00	1000	\$616.30	Ft
P1100T 20	SS	20 ft. len.	136.00	1000	CALL	Ft

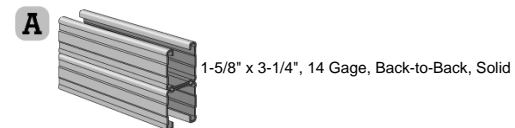

P1101 10	GR	10 ft. len.	284.00	250	\$1,370.75	Ft
P1101 10	PG	10 ft. len.	284.00	250	\$1,419.95	Ft
P1101 10	PL	10 ft. len.	284.00	250	\$1,211.85	Ft
P1101 10	SS	10 ft. len.	284.00	250	CALL	Ft
P1101 20	GR	20 ft. len.	284.00	500	\$1,370.75	Ft
P1101 20	PG	20 ft. len.	284.00	500	\$1,419.95	Ft
P1101 20	PL	20 ft. len.	284.00	500	\$1,211.85	Ft
P1101 20	SS	20 ft. len.	284.00	500	CALL	Ft

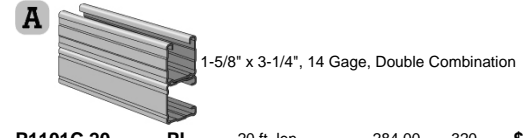

P1101C 20	PL	20 ft. len.	284.00	320	\$1,316.70	Ft
------------------	-----------	-------------	--------	-----	-------------------	----

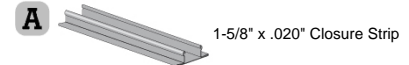

P1184 10	GR	10 ft. len.	27.00	500	\$423.20	Ft
P1184 10	PL	10 ft. len.	27.00	500	\$226.50	Ft
P1184 10	SS	10 ft. len.	27.00	500	CALL	Ft



P1184P 10	GR	10 ft. len.	10.00	500	\$791.30	Ft
P1184P 10	GY	10 ft. len.	10.00	500	\$791.30	Ft

AL-Alum.; CP-Cadmium Plated; EA- Extruded Alum.; EG-Electro-Galv.; EV-Everdur; FG-Fiberglass Reinforced Polyester; GR-Perma-Green; GY-Gray; HG-Hot Dip Galv.; MA-Maple; WH-White; NC-No Closure Strip; W/End Caps and Back Plates; PL-Plain; PG-Pre-Galv.; PO-Porcelain; SS-Stainless 304; ST-Stainless 316; WC-W/Closure Strip, End Caps and Back Plates; X-No Closure Strip or End Caps, W/Back Plates; ZD-Yellow Zinc Dichromate
 Note: For part details and loading information refer to the current Unistrut General Engineering Catalog.

Part No. Fin. Size Wt/100 Std Qty \$/100 UM

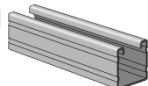
A  1-5/8" x 1-5/8", 16 Gage, Solid

P2000 10	GR	10 ft. len.	116.00	500	\$583.60	Ft
P2000 10	PG	10 ft. len.	116.00	500	\$607.20	Ft
P2000 10	HG	10 ft. len.	124.00	500	\$767.75	Ft
P2000 10	PL	10 ft. len.	116.00	500	\$507.05	Ft
P2000 20	GR	20 ft. len.	116.00	1000	\$583.60	Ft
P2000 20	PG	20 ft. len.	116.00	1000	\$607.20	Ft
P2000 20	PL	20 ft. len.	116.00	1000	\$507.05	Ft

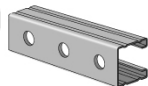
A  1-5/8" x 1-5/8", 16 Gage, Round Holes

P2000HS 20	GR	20 ft. len.	113.00	1000	\$690.70	Ft
P2000HS 20	PG	20 ft. len.	113.00	1000	\$598.05	Ft
P2000HS 20	PL	20 ft. len.	113.00	1000	\$610.30	Ft

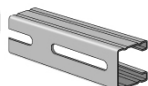
A  1-5/8" x 1-5/8", 16 Gage, Long Slots

P2000SL 10	PL	10 ft. len.	113.00	500	\$593.80	Ft
P2000SL 20	PL	20 ft. len.	113.00	1000	\$593.80	Ft

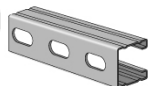
A  1-5/8" x 1-5/8", 16 Gage, Slotted

P2000T 10	GR	10 ft. len.	113.00	500	\$664.15	Ft
P2000T 10	PG	10 ft. len.	113.00	500	\$583.50	Ft
P2000T 10	HG	10 ft. len.	119.80	500	\$836.45	Ft
P2000T 10	PL	10 ft. len.	113.00	500	\$586.85	Ft
P2000T 20	GR	20 ft. len.	113.00	1000	\$664.15	Ft
P2000T 20	PG	20 ft. len.	113.00	1000	\$621.50	Ft
P2000T 20	PL	20 ft. len.	113.00	1000	\$586.85	Ft

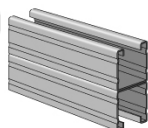
A  1-5/8" x 3-1/4", 16 Gage, Back-to-Back, Solid

P2001 10	PG	10 ft. len.	232.00	250	\$1,325.70	Ft
P2001 10	PL	10 ft. len.	232.00	250	\$1,128.30	Ft
P2001 20	GR	20 ft. len.	232.00	500	\$1,282.50	Ft
P2001 20	PG	20 ft. len.	232.00	500	\$1,325.70	Ft
P2001 20	PL	20 ft. len.	232.00	500	\$1,128.30	Ft

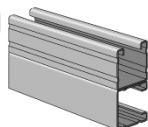
A  1-5/8" x 3-1/4", 16 Gage, Double Combination

P2001C 10	PL	10 ft. len.	232.00	160	\$1,231.80	Ft
P2001C 20	PL	20 ft. len.	232.00	320	\$1,231.80	Ft

Part No. Fin. Size Wt/100 Std Qty \$/100 UM

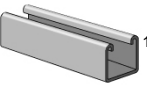
A  1-5/8" x 1-3/8", 12 Gage, Solid

P3000 10	GR	10 ft. len.	170.00	500	\$716.00	Ft
P3000 10	PG	10 ft. len.	170.00	500	\$742.30	Ft
P3000 10	HG	10 ft. len.	180.20	500	\$1,015.25	Ft
P3000 10	PL	10 ft. len.	170.00	500	\$614.35	Ft
P3000 10	SS	10 ft. len.	170.00	500	CALL	Ft
P3000 10	ST	10 ft. len.	170.00	500	CALL	Ft
P3000 20	GR	20 ft. len.	170.00	1000	\$716.00	Ft
P3000 20	PG	20 ft. len.	170.00	1000	\$742.30	Ft
P3000 20	HG	20 ft. len.	180.20	1000	\$1,015.25	Ft
P3000 20	PL	20 ft. len.	170.00	1000	\$614.35	Ft
P3000 20	SS	20 ft. len.	170.00	1000	CALL	Ft
P3000 20	ST	20 ft. len.	170.00	1000	CALL	Ft

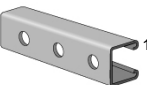
A  1-5/8" x 1-3/8", 12 Gage, Round Holes

P3000HS 10	GR	10 ft. len.	165.00	500	\$803.20	Ft
P3000HS 10	PG	10 ft. len.	165.00	500	\$846.95	Ft
P3000HS 10	PL	10 ft. len.	165.00	500	\$731.70	Ft
P3000HS 20	PG	20 ft. len.	165.00	1000	\$846.95	Ft
P3000HS 20	PL	20 ft. len.	165.00	1000	\$731.70	Ft

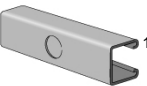
A  1-5/8" x 1-3/8", 12 Gage; Knock Outs

P3000KO 10	PL	10 ft. len.	170.00	500	\$742.10	Ft
P3000KO 20	GR	20 ft. len.	170.00	1000	\$829.40	Ft
P3000KO 20	PG	20 ft. len.	170.00	1000	\$859.10	Ft
P3000KO 20	PL	20 ft. len.	170.00	1000	\$742.10	Ft

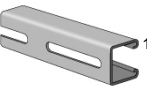
A  1-5/8" x 1-3/8", 12 Gage; Long Slots

P3000SL 10	PG	10 ft. len.	165.00	500	\$846.95	Ft
P3000SL 10	HG	10 ft. len.	169.60	500	\$1,100.00	Ft
P3000SL 20	GR	20 ft. len.	165.00	1000	\$817.85	Ft
P3000SL 20	PG	20 ft. len.	165.00	1000	\$846.95	Ft
P3000SL 20	PL	20 ft. len.	165.00	1000	\$731.70	Ft

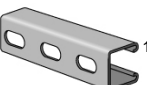
A  1-5/8" x 1-3/8", 12 Gage, Slotted

P3000T 10	GR	10 ft. len.	165.00	500	\$779.50	Ft
P3000T 10	PG	10 ft. len.	165.00	500	\$800.05	Ft
P3000T 10	PL	10 ft. len.	165.00	500	\$697.60	Ft
P3000T 20	GR	20 ft. len.	165.00	1000	\$779.50	Ft
P3000T 20	PG	20 ft. len.	165.00	1000	\$800.05	Ft
P3000T 20	HG	20 ft. len.	174.90	1000	\$1,066.05	Ft
P3000T 20	PL	20 ft. len.	165.00	1000	\$697.60	Ft

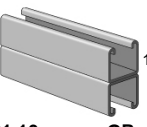
A  1-5/8" x 2 3/4", 12 Gage, Back-to-Back, Solid

P3001 10	GR	10 ft. len.	340.00	250	\$1,525.30	Ft
P3001 10	HG	10 ft. len.	360.40	250	\$2,115.50	Ft
P3001 10	PL	10 ft. len.	340.00	250	\$1,357.95	Ft
P3001 20	GR	20 ft. len.	340.00	500	\$1,525.30	Ft
P3001 20	PG	20 ft. len.	340.00	500	\$1,580.60	Ft
P3001 20	PL	20 ft. len.	340.00	500	\$1,357.95	Ft

AL-Alum.; CP-Cadmium Plated; EA- Extruded Alum.; EG-Electro-Galv.; EV-Everdur; FG-Fiberglass Reinforced Polyester; GR-Perma-Green; GY-Gray; HG-Hot Dip Galv.; MA-Maple; WH-White; NC-No Closure Strip; W/End Caps and Back Plates; PL-Plain; PG-Pre-Galv.; PO-Porcelain; SS-Stainless 304; ST-Stainless 316; WC-W/Closure Strip, End Caps and Back Plates; X-No Closure Strip or End Caps, W/Back Plates; ZD-Yellow Zinc Dichromate
 Note: For part details and loading information refer to the current Unistrut General Engineering Catalog.

Part No. Fin. Size Wt/100 Std Qty \$/100 UM

A  1-5/8" x .040" Closure Strip

P3184 10	GR	10 ft. len.	47.00	500	\$337.50	Ft
P3184 10	PG	10 ft. len.	47.00	500	\$378.70	Ft
P3184 10	PL	10 ft. len.	47.00	500	\$329.65	Ft
P3184 10	EA	10 ft. len.	21.00	500	CALL	Ft
P3184 10	SS	10 ft. len.	47.00	500	CALL	Ft

A  Closure Strip

P3184F 16	GR	16 ft. len.	90.00	256	\$748.00	Ft
P3184F 16	PG	16 ft. len.	90.00	256	\$748.00	Ft
P3184F 16	PL	16 ft. len.	90.00	256	\$583.95	Ft

A  Plastic Closure Strip

P3184P 10	GR	10 ft. len.	10.00	500	\$571.25	Ft
P3184P 10	GY	10 ft. len.	10.00	500	\$571.25	Ft

A  1-5/8" x 7/8", 12 Gage, Solid

P3300 10	GR	10 ft. len.	135.00	500	\$598.40	Ft
P3300 10	PG	10 ft. len.	135.00	500	\$614.10	Ft
P3300 10	HG	10 ft. len.	143.10	500	\$833.35	Ft
P3300 10	PL	10 ft. len.	135.00	500	\$536.05	Ft
P3300 10	SS	10 ft. len.	139.00	500	CALL	Ft
P3300 10	ST	10 ft. len.	139.00	500	CALL	Ft
P3300 20	GR	20 ft. len.	135.00	1000	\$598.40	Ft
P3300 20	PG	20 ft. len.	135.00	1000	\$614.10	Ft
P3300 20	HG	20 ft. len.	143.10	1000	\$833.35	Ft
P3300 20	ZD	20 ft. len.	135.00	1000	\$614.10	Ft
P3300 20	PL	20 ft. len.	135.00	1000	\$536.05	Ft
P3300 20	SS	20 ft. len.	139.00	1000	CALL	Ft
P3300 20	ST	20 ft. len.	139.00	1000	CALL	Ft

A  1-5/8" x 7/8", 12 Gage, Round Holes

P3300HS 10	GR	10 ft. len.	130.00	500	\$682.95	Ft
P3300HS 10	PG	10 ft. len.	130.00	500	\$700.05	Ft
P3300HS 10	HG	10 ft. len.	137.80	500	\$907.70	Ft
P3300HS 10	PL	10 ft. len.	130.00	500	\$620.45	Ft
P3300HS 20	GR	20 ft. len.	130.00	1000	\$682.95	Ft
P3300HS 20	PG	20 ft. len.	130.00	1000	\$700.05	Ft
P3300HS 20	HG	20 ft. len.	137.80	1000	\$907.70	Ft
P3300HS 20	PL	20 ft. len.	130.00	1000	\$620.45	Ft
P3300HS 20	SS	20 ft. len.	130.00	1000	CALL	Ft
P3300HS 20	ST	20 ft. len.	130.00	1000	CALL	Ft

A  1-5/8" x 7/8", 12 Gage, Long Slots

P3300SL 10	GR	10 ft. len.	130.00	500	\$682.95	Ft
P3300SL 10	PG	10 ft. len.	130.00	500	\$700.05	Ft
P3300SL 10	HG	10 ft. len.	131.40	500	\$893.30	Ft
P3300SL 10	PL	10 ft. len.	130.00	500	\$620.45	Ft
P3300SL 10	SS	10 ft. len.	130.00	500	CALL	Ft
P3300SL 20	GR	20 ft. len.	130.00	1000	\$682.95	Ft
P3300SL 20	PG	20 ft. len.	130.00	1000	\$700.05	Ft
P3300SL 20	HG	20 ft. len.	131.40	1000	\$893.30	Ft
P3300SL 20	PL	20 ft. len.	130.00	1000	\$620.45	Ft
P3300SL 20	SS	20 ft. len.	130.00	1000	CALL	Ft

Part No. Fin. Size Wt/100 Std Qty \$/100 UM

A  1-5/8" x 1-5/8", 12 Gage, Slotted

P3300T 10	GR	10 ft. len.	130.00	500	\$675.20	Ft
P3300T 10	PG	10 ft. len.	130.00	500	\$691.95	Ft
P3300T 10	HG	10 ft. len.	137.80	500	\$896.75	Ft
P3300T 10	ZD	10 ft. len.	130.00	500	\$691.95	Ft
P3300T 10	PL	10 ft. len.	130.00	500	\$613.30	Ft
P3300T 10	SS	10 ft. len.	130.00	500	CALL	Ft
P3300T 20	GR	20 ft. len.	130.00	1000	\$675.20	Ft
P3300T 20	PG	20 ft. len.	130.00	1000	\$691.95	Ft
P3300T 20	HG	20 ft. len.	137.80	1000	\$896.75	Ft
P3300T 20	ZD	20 ft. len.	130.00	1000	\$691.95	Ft
P3300T 20	PL	20 ft. len.	130.00	1000	\$613.30	Ft
P3300T 20	SS	20 ft. len.	130.00	1000	CALL	Ft

A  1-5/8" x 1 3/4", 12 Gage, Back-to-Back, Solid

P3301 10	GR	10 ft. len.	270.00	250	\$1,324.80	Ft
P3301 10	PG	10 ft. len.	270.00	250	\$1,371.35	Ft
P3301 10	HG	10 ft. len.	286.20	250	\$1,801.20	Ft
P3301 10	ZD	10 ft. len.	270.00	250	\$1,371.35	Ft
P3301 10	PL	10 ft. len.	270.00	250	\$1,199.35	Ft
P3301 10	SS	10 ft. len.	270.00	250	CALL	Ft
P3301 20	GR	20 ft. len.	270.00	500	\$1,324.80	Ft
P3301 20	PG	20 ft. len.	270.00	500	\$1,371.35	Ft
P3301 20	HG	20 ft. len.	286.20	500	\$1,801.20	Ft
P3301 20	ZD	20 ft. len.	270.00	500	\$1,371.35	Ft
P3301 20	PL	20 ft. len.	270.00	500	\$1,199.35	Ft
P3301 20	SS	20 ft. len.	270.00	500	CALL	Ft
P3301 20	ST	20 ft. len.	270.00	500	CALL	Ft

A  1-5/8" x 1 3/4", 12 Gage, Back-to-Back, Slotted

P3301T 10	PG	10 ft. len.	270.00	250	\$2,045.25	Ft
P3301T 20	PG	20 ft. len.	270.00	500	\$2,045.25	Ft

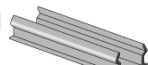
A  Plastic Closure Strip

P3712 12	P	12 ft. len.	4.80	500	\$94.15	Ft
----------	---	-------------	------	-----	---------	----

A  1-5/8" x 13/16", 16 Gage, Solid

P4000 10	GR	10 ft. len.	82.00	500	\$454.40	Ft
P4000 10	PG	10 ft. len.	82.00	500	\$471.25	Ft
P4000 10	HG	10 ft. len.	86.90	500	\$593.65	Ft
P4000 10	PL	10 ft. len.	82.00	500	\$412.80	Ft
P4000 10	EA	10 ft. len.	45.00	500	CALL	Ft
P4000 10	SS	10 ft. len.	82.00	500	CALL	Ft
P4000 10	ST	10 ft. len.	82.00	500	CALL	Ft
P4000 20	GR	20 ft. len.	82.00	1000	\$454.40	Ft
P4000 20	PG	20 ft. len.	82.00	1000	\$471.25	Ft
P4000 20	HG	20 ft. len.	86.90	1000	\$593.65	Ft
P4000 20	PL	20 ft. len.	82.00	1000	\$412.80	Ft
P4000 20	EA	20 ft. len.	45.00	1000	CALL	Ft
P4000 20	SS	20 ft. len.	82.00	1000	CALL	Ft
P4000 20	ST	20 ft. len.	82.00	1000	CALL	Ft

AL-Alum.; CP-Cadmium Plated; EA- Extruded Alum.; EG-Electro-Galv.; EV-Everdur; FG-Fiberglass Reinforced Polyester; GR-Perma-Green; GY-Gray; HG-Hot Dip Galv.; MA-Maple; WH-White; NC-No Closure Strip; W/End Caps and Back Plates; PL-Plain; PG-Pre-Galv.; PO-Porcelain; SS-Stainless 304; ST-Stainless 316; WC-W/Closure Strip, End Caps and Back Plates; X-No Closure Strip or End Caps, W/Back Plates; ZD-Yellow Zinc Dichromate
 Note: For part details and loading information refer to the current Unistrut General Engineering Catalog.

Part No.	Fin.	Size	Wt/100	Std Qty	\$/100	UM
 1-5/8" x 13/16", 16 Gage, Round Holes						
P4000HS 10	GR	10 ft. len.	79.00	500	\$558.65	Ft
P4000HS 10	PG	10 ft. len.	79.00	500	\$578.75	Ft
P4000HS 10	HG	10 ft. len.	83.70	500	\$672.55	Ft
P4000HS 10	PL	10 ft. len.	79.00	500	\$498.85	Ft
P4000HS 10	EA	10 ft. len.	41.00	500	CALL	Ft
P4000HS 20	GR	20 ft. len.	79.00	1000	\$558.65	Ft
P4000HS 20	PG	20 ft. len.	79.00	1000	\$578.75	Ft
P4000HS 20	PL	20 ft. len.	79.00	1000	\$498.85	Ft
P4000HS 20	EA	20 ft. len.	41.00	1000	CALL	Ft

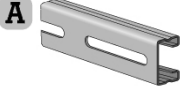
Part No.	Fin.	Size	Wt/100	Std Qty	\$/100	UM
 1-5/8" x 13/16", 16 Gage, Long Slots						
P4000SL 10	GR	10 ft. len.	79.00	500	\$558.65	Ft
P4000SL 10	PL	10 ft. len.	79.00	500	\$498.85	Ft
P4000SL 20	GR	20 ft. len.	79.00	1000	\$558.65	Ft
P4000SL 20	PG	20 ft. len.	79.00	1000	\$578.75	Ft
P4000SL 20	PL	20 ft. len.	79.00	1000	\$498.85	Ft
P4000SL 20	EA	20 ft. len.	79.00	1000	CALL	Ft

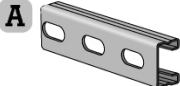
Part No.	Fin.	Size	Wt/100	Std Qty	\$/100	UM
 1-5/8" x 13/16", 16 Gage, Slotted						
P4000T 10	GR	10 ft. len.	79.00	500	\$552.30	Ft
P4000T 10	PG	10 ft. len.	79.00	500	\$572.40	Ft
P4000T 10	HG	10 ft. len.	83.70	500	\$664.70	Ft
P4000T 10	PL	10 ft. len.	79.00	500	\$492.70	Ft
P4000T 10	EA	10 ft. len.	42.00	500	CALL	Ft
P4000T 10	SS	10 ft. len.	79.00	500	CALL	Ft
P4000T 10	ST	10 ft. len.	79.00	500	CALL	Ft
P4000T 20	GR	20 ft. len.	79.00	1000	\$552.30	Ft
P4000T 20	PG	20 ft. len.	79.00	1000	\$572.40	Ft
P4000T 20	HG	20 ft. len.	83.70	1000	\$664.70	Ft
P4000T 20	ZD	20 ft. len.	79.00	1000	\$572.40	Ft
P4000T 20	PL	20 ft. len.	79.00	1000	\$492.70	Ft
P4000T 20	EA	20 ft. len.	42.00	1000	CALL	Ft
P4000T 20	SS	20 ft. len.	79.00	1000	CALL	Ft
P4000T 20	ST	20 ft. len.	79.00	1000	CALL	Ft

Part No.	Fin.	Size	Wt/100	Std Qty	\$/100	UM
 1-5/8" x 1-5/8", 16 Gage, Back-to-Back, Solid						
P4001 10	GR	10 ft. len.	164.00	250	\$1,074.25	Ft
P4001 10	PG	10 ft. len.	164.00	250	\$1,112.05	Ft
P4001 10	HG	10 ft. len.	173.80	250	\$1,318.30	Ft
P4001 10	PL	10 ft. len.	164.00	250	\$951.05	Ft
P4001 10	EA	10 ft. len.	66.00	500	CALL	Ft
P4001 20	GR	20 ft. len.	164.00	500	\$1,074.25	Ft
P4001 20	PG	20 ft. len.	164.00	500	\$1,112.05	Ft
P4001 20	HG	20 ft. len.	173.80	500	\$1,318.30	Ft
P4001 20	PL	20 ft. len.	164.00	500	\$951.05	Ft
P4001 20	EA	20 ft. len.	66.00	500	CALL	Ft
P4001 20	SS	20 ft. len.	164.00	500	CALL	Ft

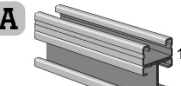
Part No.	Fin.	Size	Wt/100	Std Qty	\$/100	UM
 1-5/8" x 2 7/16", 16 Gage, Triple Combination						
P4003 10	PG	10 ft. len.	246.00	10	\$2,409.70	Ft
P4003 10	PL	10 ft. len.	246.00	10	\$1,951.35	Ft
P4003 20	GR	20 ft. len.	246.00	20	\$2,164.60	Ft
P4003 20	PG	20 ft. len.	246.00	20	\$2,361.30	Ft
P4003 20	HG	20 ft. len.	261.00	20	\$2,000.45	Ft
P4003 20	PL	20 ft. len.	246.00	20	\$1,951.35	Ft
P4003 20	EA	20 ft. len.	108.00	20	CALL	Ft

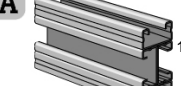
Part No.	Fin.	Size	Wt/100	Std Qty	\$/100	UM
 1-5/8" x 3-1/4", 16 Gage, Quadruple Combination						
P4004 20	GR	20 ft. len.	328.00	20	\$2,968.80	Ft
P4004 20	PL	20 ft. len.	328.00	20	\$2,688.60	Ft
P4004 20	EA	20 ft. len.	143.00	20	CALL	Ft
P4004 20	SS	20 ft. len.	328.00	20	CALL	Ft

Part No.	Fin.	Size	Wt/100	Std Qty	\$/100	UM
 1-5/8" x 13/16", 14 Gage, Solid						
P4100 10	GR	10 ft. len.	97.00	500	\$495.40	Ft
P4100 10	PG	10 ft. len.	97.00	500	\$515.50	Ft
P4100 10	HG	10 ft. len.	102.80	500	\$648.20	Ft
P4100 10	ZD	10 ft. len.	97.00	500	\$515.50	Ft
P4100 10	PL	10 ft. len.	97.00	500	\$435.45	Ft
P4100 10	SS	10 ft. len.	97.00	500	CALL	Ft
P4100 20	GR	20 ft. len.	97.00	1000	\$495.40	Ft
P4100 20	PG	20 ft. len.	97.00	1000	\$515.50	Ft
P4100 20	HG	20 ft. len.	102.80	1000	\$648.20	Ft
P4100 20	ZD	20 ft. len.	97.00	1000	\$515.50	Ft
P4100 20	PL	20 ft. len.	97.00	1000	\$435.45	Ft
P4100 20	SS	20 ft. len.	97.00	1000	CALL	Ft

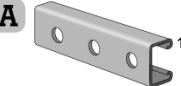
Part No.	Fin.	Size	Wt/100	Std Qty	\$/100	UM
 1-5/8" x 13/16", 14 Gage, Round Holes						
P4100HS 10	GR	10 ft. len.	87.00	500	\$580.05	Ft
P4100HS 10	PG	10 ft. len.	87.00	500	\$601.65	Ft
P4100HS 10	HG	10 ft. len.	92.20	500	\$711.00	Ft
P4100HS 10	ZD	10 ft. len.	87.00	500	\$601.65	Ft
P4100HS 10	PL	10 ft. len.	87.00	500	\$519.75	Ft
P4100HS 10	SS	10 ft. len.	87.00	500	CALL	Ft
P4100HS 20	GR	20 ft. len.	87.00	1000	\$580.05	Ft
P4100HS 20	PG	20 ft. len.	87.00	1000	\$601.65	Ft
P4100HS 20	PL	20 ft. len.	87.00	1000	\$519.75	Ft
P4100HS 20	SS	20 ft. len.	87.00	1000	CALL	Ft

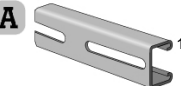
Part No.	Fin.	Size	Wt/100	Std Qty	\$/100	UM
 1-5/8" x 13/16", 14 Gage, Long Slots						
P4100SL 10	GR	10 ft. len.	87.00	500	\$580.05	Ft
P4100SL 10	PG	10 ft. len.	87.00	500	\$601.65	Ft
P4100SL 10	HG	10 ft. len.	87.00	500	\$711.00	Ft
P4100SL 20	GR	20 ft. len.	87.00	1000	\$580.05	Ft
P4100SL 20	PG	20 ft. len.	87.00	1000	\$601.65	Ft
P4100SL 20	SS	20 ft. len.	87.00	1000	CALL	Ft

AL-Alum.; CP-Cadmium Plated; EA- Extruded Alum.; EG-Electro-Galv.; EV-Everdur; FG-Fiberglass Reinforced Polyester; GR-Perma-Green; GY-Gray; HG-Hot Dip Galv.; MA-Maple; WH-White; NC-No Closure Strip; W/End Caps and Back Plates; PL-Plain; PG-Pre-Galv.; PO-Porcelain; SS-Stainless 304; ST-Stainless 316; WC-W/Closure Strip, End Caps and Back Plates; X-No Closure Strip or End Caps, W/Back Plates; ZD-Yellow Zinc Dichromate
 Note: For part details and loading information refer to the current Unistrut General Engineering Catalog.

Part No. Fin. Size Wt/100 Std Qty \$/100 UM

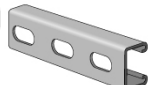
A  1-5/8" x 13/16", 14 Gage, Slotted

P4100T 10	GR	10 ft. len.	87.00	500	\$573.35	Ft
P4100T 10	PG	10 ft. len.	87.00	500	\$594.50	Ft
P4100T 10	HG	10 ft. len.	92.20	500	\$703.40	Ft
P4100T 10	ZD	10 ft. len.	87.00	500	\$594.50	Ft
P4100T 10	PL	10 ft. len.	87.00	500	\$513.05	Ft
P4100T 10	SS	10 ft. len.	97.00	500	CALL	Ft
P4100T 20	GR	20 ft. len.	87.00	1000	\$573.35	Ft
P4100T 20	PG	20 ft. len.	87.00	1000	\$594.50	Ft
P4100T 20	HG	20 ft. len.	92.20	1000	\$703.40	Ft
P4100T 20	ZD	20 ft. len.	87.00	1000	\$594.50	Ft
P4100T 20	PL	20 ft. len.	87.00	1000	\$513.05	Ft
P4100T 20	SS	20 ft. len.	97.00	1000	CALL	Ft

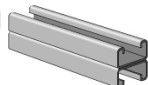
A  1-5/8" x 1-5/8", 14 Gage, Back-to-Back, Solid

P4101 10	GR	10 ft. len.	194.00	250	\$1,115.05	Ft
P4101 10	PG	10 ft. len.	194.00	250	\$1,157.45	Ft
P4101 10	HG	10 ft. len.	205.60	250	\$1,427.80	Ft
P4101 10	ZD	10 ft. len.	194.00	250	\$1,157.45	Ft
P4101 10	PL	10 ft. len.	194.00	250	\$994.45	Ft
P4101 20	GR	20 ft. len.	194.00	500	\$1,115.05	Ft
P4101 20	PG	20 ft. len.	194.00	500	\$1,157.45	Ft
P4101 20	HG	20 ft. len.	205.60	500	\$1,427.80	Ft
P4101 20	PL	20 ft. len.	194.00	500	\$994.45	Ft

A  1-5/8" x 1-5/8", 14 Gage Back-to-Back, Slotted

P4101T 10	GR	10 ft. len.	174.00	250	\$1,725.45	Ft
P4101T 10	PG	10 ft. len.	174.00	250	\$1,888.55	Ft
P4101T 10	ZD	10 ft. len.	174.00	500	\$1,888.55	Ft
P4101T 20	GR	20 ft. len.	174.00	500	\$1,725.45	Ft
P4101T 20	PG	20 ft. len.	174.00	500	\$1,888.55	Ft
P4101T 20	ZD	20 ft. len.	174.00	500	\$1,888.55	Ft

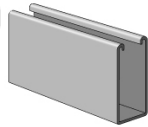
A  1-5/8" x 3-1/4", 12 Gage, Solid

P5000 10	GR	10 ft. len.	305.00	250	\$1,340.95	Ft
P5000 10	PG	10 ft. len.	305.00	250	\$1,441.10	Ft
P5000 10	HG	10 ft. len.	323.30	250	\$1,865.65	Ft
P5000 10	PL	10 ft. len.	305.00	250	\$1,186.65	Ft
P5000 20	GR	20 ft. len.	305.00	500	\$1,340.95	Ft
P5000 20	PG	20 ft. len.	305.00	500	\$1,441.10	Ft
P5000 20	HG	20 ft. len.	323.30	500	\$1,865.65	Ft
P5000 20	PL	20 ft. len.	305.00	500	\$1,186.65	Ft

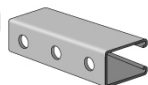
A  1-5/8" x 3-1/4", 12 Gage, Round Holes

P5000HS 10	GR	10 ft. len.	300.00	250	\$1,466.95	Ft
P5000HS 10	PG	10 ft. len.	300.00	250	\$1,600.50	Ft
P5000HS 10	PL	10 ft. len.	300.00	250	\$1,308.40	Ft
P5000HS 20	GR	20 ft. len.	300.00	500	\$1,466.95	Ft
P5000HS 20	PG	20 ft. len.	300.00	500	\$1,600.50	Ft
P5000HS 20	PL	20 ft. len.	300.00	500	\$1,308.40	Ft

Part No. Fin. Size Wt/100 Std Qty \$/100 UM

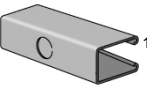
A  1-5/8" x 3-1/4", 12 Gage; Knock Outs

P5000KO 10	HG	10 ft. len.	305.00	250	\$1,629.60	Ft
P5000KO 20	PL	20 ft. len.	305.00	500	\$1,308.40	Ft

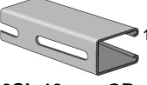
A  1-5/8" x 3-1/4", 12 Gage; SL Slots

P5000SL 10	GR	10 ft. len.	284.00	250	\$1,466.95	Ft
P5000SL 10	PG	10 ft. len.	284.00	250	\$1,629.60	Ft
P5000SL 10	PL	10 ft. len.	284.00	250	\$1,308.40	Ft
P5000SL 20	GR	20 ft. len.	284.00	500	\$1,466.95	Ft
P5000SL 20	PG	20 ft. len.	284.00	500	\$1,629.60	Ft
P5000SL 20	PL	20 ft. len.	284.00	500	\$1,308.40	Ft

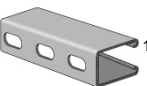
A  1-5/8" x 3-1/4", 12 Gage, Slotted

P5000T 10	GR	10 ft. len.	300.00	250	\$1,411.05	Ft
P5000T 10	PG	10 ft. len.	300.00	250	\$1,539.25	Ft
P5000T 10	ZD	10 ft. len.	300.00	250	\$1,539.25	Ft
P5000T 10	PL	10 ft. len.	300.00	250	\$1,258.25	Ft
P5000T 20	GR	20 ft. len.	300.00	500	\$1,411.05	Ft
P5000T 20	PG	20 ft. len.	300.00	500	\$1,539.25	Ft
P5000T 20	ZD	20 ft. len.	300.00	500	\$1,539.25	Ft
P5000T 20	PL	20 ft. len.	300.00	500	\$1,258.25	Ft

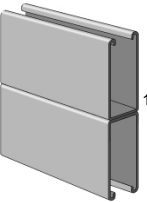
A  1-5/8" x 6 1/2", 12 Gage, Back-to-Back, Solid

P5001 10	GR	10 ft. len.	610.00	100	\$2,899.40	Ft
P5001 10	PG	10 ft. len.	610.00	100	\$3,213.55	Ft
P5001 10	HG	10 ft. len.	646.60	100	\$3,950.20	Ft
P5001 10	PL	10 ft. len.	610.00	100	\$2,591.00	Ft
P5001 20	GR	20 ft. len.	610.00	200	\$2,899.40	Ft
P5001 20	PG	20 ft. len.	610.00	200	\$3,213.55	Ft
P5001 20	HG	20 ft. len.	646.60	200	\$3,950.20	Ft
P5001 20	PL	20 ft. len.	610.00	200	\$2,591.00	Ft

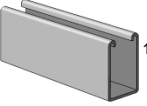
A  1-5/8" x 2 7/16", 12 Gage, Solid

P5500 10	GR	10 ft. len.	247.00	250	\$1,069.55	Ft
P5500 10	PG	10 ft. len.	247.00	250	\$1,163.20	Ft
P5500 10	HG	10 ft. len.	261.80	250	\$1,500.60	Ft
P5500 10	PL	10 ft. len.	247.00	250	\$950.55	Ft
P5500 10	EA	10 ft. len.	97.00	250	CALL	Ft
P5500 20	GR	20 ft. len.	247.00	500	\$1,069.55	Ft
P5500 20	PG	20 ft. len.	247.00	500	\$1,163.20	Ft
P5500 20	HG	20 ft. len.	261.80	500	\$1,500.60	Ft
P5500 20	PL	20 ft. len.	247.00	500	\$950.55	Ft
P5500 20	EA	20 ft. len.	97.00	500	CALL	Ft

AL-Alum.; CP-Cadmium Plated; EA- Extruded Alum.; EG-Electro-Galv.; EV-Everdur; FG-Fiberglass Reinforced Polyester; GR-Perma-Green; GY-Gray; HG-Hot Dip Galv.; MA-Maple; WH-White; NC-No Closure Strip; W/End Caps and Back Plates; PL-Plain; PG-Pre-Galv.; PO-Porcelain; SS-Stainless 304; ST-Stainless 316; WC-W/Closure Strip, End Caps and Back Plates; X-No Closure Strip or End Caps, W/Back Plates; ZD-Yellow Zinc Dichromate
 Note: For part details and loading information refer to the current Unistrut General Engineering Catalog.

Part No. Fin. Size Wt/100 Std Qty \$/100 U/M

Part No. Fin. Size Wt/100 Std Qty \$/100 U/M

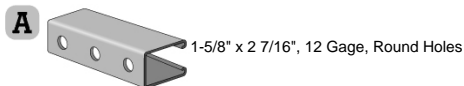

P5500HS 10	GR	10 ft. len.	242.00	250	\$1,187.45	Ft
P5500HS 10	PL	10 ft. len.	242.00	250	\$1,066.05	Ft
P5500HS 20	GR	20 ft. len.	242.00	500	\$1,187.45	Ft
P5500HS 20	PG	20 ft. len.	242.00	500	\$1,286.00	Ft
P5500HS 20	PL	20 ft. len.	242.00	500	\$1,066.05	Ft

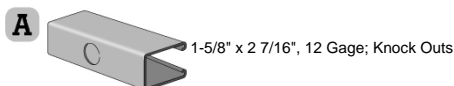

P5500KO 10	HG	10 ft. len.	261.80	250	\$1,660.75	Ft
P5500KO 10	PL	10 ft. len.	247.00	250	\$1,066.05	Ft
P5500KO 20	GR	20 ft. len.	247.00	500	\$1,187.45	Ft
P5500KO 20	PG	20 ft. len.	247.00	500	\$1,286.00	Ft

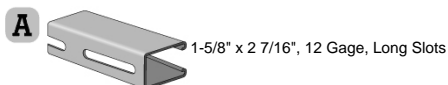

P5500SL 10	GR	10 ft. len.	237.00	250	\$1,187.45	Ft
P5500SL 10	PG	10 ft. len.	237.00	250	\$1,286.00	Ft
P5500SL 10	ZD	10 ft. len.	242.00	250	\$1,286.00	Ft
P5500SL 10	PL	10 ft. len.	237.00	250	\$1,066.05	Ft
P5500SL 20	GR	20 ft. len.	237.00	500	\$1,187.45	Ft
P5500SL 20	PG	20 ft. len.	237.00	500	\$1,286.00	Ft
P5500SL 20	HG	20 ft. len.	251.20	500	\$1,638.15	Ft
P5500SL 20	PL	20 ft. len.	237.00	500	\$1,066.05	Ft

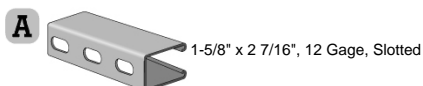

P5500T 10	GR	10 ft. len.	242.00	250	\$1,142.05	Ft
P5500T 10	PG	10 ft. len.	242.00	250	\$1,236.90	Ft
P5500T 10	HG	10 ft. len.	256.50	250	\$1,558.45	Ft
P5500T 10	ZD	10 ft. len.	242.00	250	\$1,236.90	Ft
P5500T 10	PL	10 ft. len.	242.00	250	\$1,025.50	Ft
P5500T 20	GR	20 ft. len.	242.00	500	\$1,142.05	Ft
P5500T 20	PG	20 ft. len.	242.00	500	\$1,236.90	Ft
P5500T 20	HG	20 ft. len.	256.50	500	\$1,558.45	Ft
P5500T 20	ZD	20 ft. len.	242.00	500	\$1,236.90	Ft
P5500T 20	PL	20 ft. len.	242.00	500	\$1,025.50	Ft

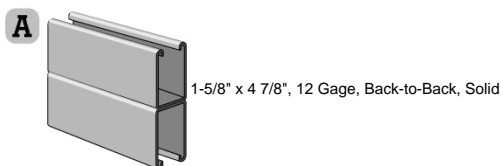

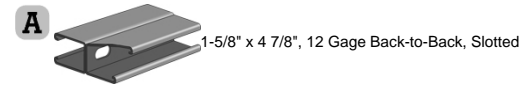

P5501 10	GR	10 ft. len.	494.00	150	\$2,356.55	Ft
P5501 10	PG	10 ft. len.	494.00	150	\$2,600.35	Ft
P5501 10	HG	10 ft. len.	494.00	150	\$3,078.20	Ft
P5501 10	PL	10 ft. len.	494.00	150	\$2,119.65	Ft
P5501 20	GR	20 ft. len.	494.00	300	\$2,356.55	Ft
P5501 20	PG	20 ft. len.	494.00	300	\$2,600.35	Ft
P5501 20	HG	20 ft. len.	523.60	300	\$3,078.20	Ft
P5501 20	ZD	20 ft. len.	494.00	300	\$2,600.35	Ft
P5501 20	PL	20 ft. len.	494.00	300	\$2,119.65	Ft





P5501T 20	GR	20 ft. len.	494.00	300	\$3,112.15	Ft
P5501T 20	PG	20 ft. len.	494.00	300	\$3,694.40	Ft
P5501T 20	HG	20 ft. len.	524.00	300	\$4,371.80	Ft
P5501T 20	ZD	20 ft. len.	494.00	300	\$3,694.40	Ft
P5501T 20	PL	20 ft. len.	494.00	300	\$2,709.85	Ft

AL-Alum.; CP-Cadmium Plated; EA- Extruded Alum.; EG-Electro-Galv.; EV-Everdur; FG-Fiberglass Reinforced Polyester; GR-Perma-Green; GY-Gray; HG-Hot Dip Galv.; MA-Maple; WH-White; NC-No Closure Strip; W/End Caps and Back Plates; PL-Plain; PG-Pre-Galv.; PO-Porcelain; SS-Stainless 304; ST-Stainless 316; WC-W/Closure Strip, End Caps and Back Plates; X-No Closure Strip or End Caps, W/Back Plates; ZD-Yellow Zinc Dichromate
 Note: For part details and loading information refer to the current Unistrut General Engineering Catalog.

Part No.	Fin.	Size	Wt/100	Std Qty	\$/100 UM
 D					
HCSS031150	EG	5/16" x 1-1/2"	3.90	400	\$643.70 Pcs
HCSS037150	EG	3/8" x 1-1/2"	4.50	300	\$692.65 Pcs
HCSS037200	EG	3/8" x 2"	6.10	250	\$733.30 Pcs
HCSS050150	EG	1/2" x 1-1/2"	8.50	100	\$774.10 Pcs
HCSS050200	EG	1/2" x 2"	11.40	100	\$855.60 Pcs

Part No.	Fin.	Size	Wt/100	Std Qty	\$/100 UM
 D					
HFLW025	EG	1/4"	0.80	500	\$17.80 Pcs
HFLW031	EG	5/16"	1.00	500	\$23.00 Pcs
HFLW037	EG	3/8"	1.50	500	\$25.30 Pcs
HFLW050	EG	1/2"	3.50	250	\$40.30 Pcs
HFLW062	EG	5/8"	3.90	200	\$100.35 Pcs
HFLW075	EG	3/4"	4.70	100	\$129.00 Pcs

Part No.	Fin.	Size	Wt/100	Std Qty	\$/100 UM
 D					
HFMS025062	EG	1/4" x 5/8"	1.20	500	\$24.95 Pcs
HFMS031100	EG	5/16" x 1"	2.60	500	\$63.55 Pcs
HFMS050100	EG	1/2" x 1"	9.30	100	\$125.45 Pcs

Part No.	Fin.	Size	Wt/100	Std Qty	\$/100 UM
 D					
HHCS025044	EG	1/4" x 7/16"	1.00	500	\$32.20 Pcs
HHCS025075	EG	1/4" x 3/4"	1.30	500	\$33.85 Pcs
HHCS025100	EG	4-Jan x 1	2.00	500	\$39.05 Pcs
HHCS025125	EG	1/4" x 1-1/4"	2.40	200	\$43.20 Pcs
HHCS025150	EG	1/4" x 1-1/2"	2.60	250	\$49.45 Pcs
HHCS031125	EG	5/16" x 1-1/4"	3.60	300	\$52.10 Pcs
HHCS037075	EG	3/8" x 3/4"	4.00	250	\$53.50 Pcs
HHCS037087	EG	3/8" x 7/8"	4.40	250	\$56.70 Pcs
HHCS037100	EG	8-Mar x 1	4.50	250	\$56.50 Pcs
HHCS037125	EG	3/8" x 1-1/4"	5.30	150	\$67.45 Pcs
HHCS037150	EG	3/8" x 1-1/2"	6.00	250	\$73.55 Pcs
HHCS037200	EG	3/8" x 2"	7.60	100	\$94.85 Pcs
HHCS037225	BG	8-Mar x 2/1/04	8.40	100	\$100.50 Pcs
HHCS037250	EG	3/8" x 2-1/2"	9.20	100	\$117.00 Pcs
HHCS050094	EG	1/2" x 15/16	9.10	200	\$100.35 Pcs
HHCS050094	BG	1/2" x 15/16	9.10	2000	\$74.25 Pcs
HHCS050119	EG	1/2" x 1-3/16"	10.20	250	\$117.10 Pcs
HHCS050119	BG	2-Jan x 1/3/16	10.20	1600	\$90.90 Pcs
HHCS050125	EG	1/2" x 1-1/4"	11.00	100	\$120.25 Pcs
HHCS050150	EG	1/2" x 1-1/2"	11.60	100	\$129.25 Pcs
HHCS050150	BG	1/2" x 1-1/2"	11.60	1000	\$83.30 Pcs
HHCS050175	EG	1/2" x 1-3/4"	13.10	150	\$148.65 Pcs
HHCS050200	EG	1/2" x 2"	14.60	100	\$166.90 Pcs
HHCS050225	EG	1/2" x 2-1/4"	16.00	100	\$181.00 Pcs
HHCS050250	EG	1/2" x 2-1/2"	17.50	100	\$190.70 Pcs

Part No.	Fin.	Size	Wt/100	Std Qty	\$/100 UM
 D					
HHXN025	EG	1/4"	0.60	500	\$17.80 Pcs
HHXN031	EG	5/16"	1.20	500	\$22.20 Pcs
HHXN037	EG	3/8"	1.60	500	\$26.70 Pcs
HHXN050	EG	1/2"	4.80	250	\$59.50 Pcs
HHXN062	EG	5/8"	7.30	100	\$89.75 Pcs
HHXN075	EG	3/4"	14.00	100	\$137.55 Pcs

Part No.	Fin.	Size	Wt/100	Std Qty	\$/100 UM
 D					
HLKW025	EG	1/4"	0.30	100	\$14.90 Pcs
HLKW031	EG	5/16"	0.40	100	\$17.80 Pcs
HLKW037	EG	3/8"	0.60	500	\$21.25 Pcs
HLKW050	EG	1/2"	1.30	500	\$24.60 Pcs
HLKW062	EG	5/8"	2.20	250	\$45.30 Pcs
HLKW075	EG	3/4"	3.80	200	\$86.15 Pcs

Part No.	Fin.	Size	Wt/100	Std Qty	\$/100 UM
 D					
HOCW025	EG	4-Jan	1.00	100	\$47.35 Pcs
HOCW037	EG	8-Mar	1.00	100	\$50.35 Pcs

Part No.	Fin.	Size	Wt/100	Std Qty	\$/100 UM
 D					
HRCN025	EG	1/4"	2.00	200	\$102.00 Pcs
HRCN031	EG	5/16"	15.00	100	\$436.60 Pcs
HRCN037	EG	3/8"	12.00	100	\$248.20 Pcs
HRCN050	EG	1/2"	13.00	100	\$299.40 Pcs
HRCN062	EG	5/8"	19.00	100	\$574.60 Pcs
HRCN075	EG	3/4"	23.00	100	\$825.60 Pcs
HRCN087	EG	7/8"	59.00	100	\$2,282.85 Pcs
HRCN100	EG	1"	73.00	100	\$2,333.55 Pcs

Part No.	Fin.	Size	Wt/100	Std Qty	\$/100 UM
 D					
HRMS025050	EG	1/4" x 1/2"	1.00	500	\$56.25 Pcs
HRMS025075	EG	1/4" x 3/4"	1.20	500	\$56.00 Pcs
HRMS025100	EG	1/4" x 1"	1.50	500	\$50.95 Pcs
HRMS031100	EG	5/16" x 1"	2.60	500	\$85.70 Pcs
HRMS031125	EG	5/16" x 1-1/4"	3.00	400	\$118.50 Pcs
HRMS037100	EG	3/8" x 1"	4.10	350	\$128.45 Pcs

Part No.	Fin.	Size	Wt/100	Std Qty	\$/100 UM
 D					
HSHS025050	EG	1/4" x 1/2"	1.40	500	\$86.85 Pcs
HSHS025062	EG	1/4" x 5/8"	1.50	500	\$100.00 Pcs
HSHS025075	EG	1/4" x 3/4"	1.70	500	\$102.80 Pcs
HSHS025100	EG	1/4" x 1"	1.90	350	\$162.75 Pcs
HSHS025125	EG	1/4" x 1-1/4"	3.00	300	\$250.50 Pcs
HSHS031100	EG	5/16" x 1"	2.60	500	\$169.00 Pcs
HSHS031125	EG	5/16" x 1-1/4"	3.00	500	\$188.75 Pcs
HSHS031150	EG	5/16" x 1-1/2"	3.40	500	\$216.00 Pcs
HSHS037125	EG	3/8" x 1-1/4"	5.30	250	\$198.10 Pcs

Part No.	Fin.	Size	Wt/100	Std Qty	\$/100 UM
 D					
HSQN025	EG	1/4"	0.90	500	\$18.60 Pcs
HSQN031	EG	5/16"	1.60	500	\$24.95 Pcs
HSQN037	EG	3/8"	2.70	250	\$33.85 Pcs
HSQN050	EG	1/2"	5.80	250	\$86.30 Pcs
HSQN062	EG	5/8"	10.70	200	\$278.45 Pcs

AL-Alum.; CP-Cadmium Plated; EA- Extruded Alum.; EG-Electro-Galv.; EV-Everdur; FG-Fiberglass Reinforced Polyester; GR-Perma-Green; GY-Gray; HG-Hot Dip Galv.; MA-Maple; WH-White; NC-No Closure Strip; W/End Caps and Back Plates; PL-Plain; PG-Pre-Galv.; PO-Porcelain; SS-Stainless 304; ST-Stainless 316; WC-W/Closure Strip, End Caps and Back Plates; X-No Closure Strip or End Caps, W/Back Plates; ZD-Yellow Zinc Dichromate
 Note: For part details and loading information refer to the current Unistrut General Engineering Catalog.

Part No.	Fin.	Size	Wt/100	Std Qty	\$/100	UM
E 	Steel Threaded Rod					
HTHR025 10	EG	1/4" x 10	12.00	500	\$111.70	Ft
HTHR025 12	EG	1/4" x 12	12.00	600	\$111.70	Ft
HTHR031 10	EG	5/16" x 10	20.00	350	\$169.80	Ft
HTHR031 12	EG	5/16" x 12	20.00	420	\$169.80	Ft
HTHR037 10	EG	3/8" x 10	29.00	250	\$173.85	Ft
HTHR037 12	EG	3/8" x 12	29.00	300	\$173.85	Ft
HTHR044 10	EG	7/16" x 10	40.00	170	\$420.40	Ft
HTHR050 10	EG	1/2" x 10	53.00	120	\$327.55	Ft
HTHR050 12	EG	1/2" x 12	53.00	144	\$327.55	Ft
HTHR062 10	EG	5/8" x 10	84.00	80	\$537.75	Ft
HTHR062 12	EG	5/8" x 12	84.00	96	\$537.75	Ft
HTHR075 10	EG	3/4" x 10	123.00	50	\$800.40	Ft
HTHR075 12	EG	3/4" x 12	123.00	60	\$800.40	Ft
HTHR100 10	EG	1" x 10	219.00	20	\$1,520.10	Ft

Part No.	Fin.	Wt/100	Std Qty	\$/100	UM	
C 	K1062	EG	1.20	0	\$369.60	Pcs
K1063	EG	2.60	0	\$369.60	Pcs	
K1064	EG	9.30	0	\$369.60	Pcs	

Part No.	Fin.	Size	Wt/100	Std Qty	\$/100	UM	
C 	P1006-0832	EG	#8-32	7.00	100	\$603.35	Pcs
P1006-1024	EG	#10-24	7.00	100	\$613.05	Pcs	
P1006-1024	SS	#10-24	7.00	100	CALL	Pcs	
P1006-1032	EG	#10-32	7.00	100	\$631.20	Pcs	
P1006-1420	EG	1/4"-20	7.00	100	\$190.10	Pcs	
P1006-1420	HG	1/4"-20	8.00	100	\$577.85	Pcs	
P1006-1420	AL	1/4"-20	3.00	100	CALL	Pcs	
P1006U1420	SS	1/4"-20	7.00	100	CALL	Pcs	
P1007	EG	5/16"-18	6.00	100	\$194.85	Pcs	
P1007	HG	5/16"-18	7.00	100	\$575.55	Pcs	
P1007	AL	5/16"-18	3.00	100	CALL	Pcs	
P1007	SS	5/16"-18	6.00	100	CALL	Pcs	
P1008	EG	3/8"-16	10.00	100	\$200.15	Pcs	
P1008	HG	3/8"-16	11.00	100	\$572.40	Pcs	
P1008	AL	3/8"-16	3.00	100	CALL	Pcs	
P1008U	SS	3/8"-16	10.00	100	CALL	Pcs	
P1009	EG	7/16"-14	9.00	100	\$287.25	Pcs	
P1010	EG	1/2"-13	12.00	100	\$217.35	Pcs	
P1010	HG	1/2"-13	13.00	100	\$611.45	Pcs	
P1010	AL	1/2"-13	3.60	100	CALL	Pcs	
P1010U	SS	1/2"-13	11.00	100	CALL	Pcs	

Part No.	Fin.	Size	Wt/100	Std Qty	\$/100	UM	
C 	P1006T1420	EG	1/4"-20	7.00	100	\$395.60	Pcs
P1008T	EG	3/8"-16	10.00	100	\$446.30	Pcs	
P1010T	EG	1/2"-13	15.00	100	\$499.10	Pcs	
P4008UT	SS	1/2"-13	10.00	100	CALL	Pcs	
P4010T	EG	1/2"-13	8.00	100	\$538.70	Pcs	
P4010UT	SS	1/2"-13	11.00	100	CALL	Pcs	

Part No.	Fin.	Size	Wt/100	Std Qty	\$/100	UM	
C 	P1012	EG	5/8"-11	20.00	100	\$336.00	Pcs
P1012	SS	5/8"-11	21.00	100	CALL	Pcs	
P1023	EG	3/4"-10	20.00	100	\$464.90	Pcs	
P1024	EG	7/8"-9	20.00	100	\$515.00	Pcs	

Part No.	Fin.	Size	Wt/100	Std Qty	\$/100	UM	
C 	P1012S	EG	5/8"-11	21.00	100	\$474.35	Pcs
P1012S	HG	5/8"-11	23.00	100	\$829.15	Pcs	
P1012S	SS	5/8"-11	21.00	100	CALL	Pcs	
P1023S	EG	3/4"-10	21.00	100	\$730.20	Pcs	
P1023S	HG	3/4"-10	23.00	100	\$1,120.00	Pcs	
P1023S	SS	3/4"-10	21.00	100	CALL	Pcs	
P1024S	EG	7/8"-9	21.00	100	\$783.80	Pcs	

Part No.	Fin.	Size	Wt/100	Std Qty	\$/100	UM	
C 	P1016	EG	3/8"-16	17.40	0	\$173.25	Pcs

Part No.	Fin.	Size	Wt/100	Std Qty	\$/100	UM	
D 	P2378-1	EG	1/4"-20	8.00	100	\$433.25	Pcs
P2378-2	EG	1/4"-20	9.00	100	\$444.70	Pcs	
P2378-3	EG	1/4"-20	9.00	50	\$449.75	Pcs	
P2379-1	EG	5/16"-18	12.00	50	\$456.10	Pcs	
P2379-2	EG	5/16"-18	12.00	20	\$462.45	Pcs	
P2379-3	EG	5/16"-18	13.00	50	\$495.50	Pcs	
P2380-1	EG	3/8"-16	13.00	100	\$468.80	Pcs	
P2380-2	EG	3/8"-16	13.00	100	\$471.35	Pcs	
P2380-3	EG	3/8"-16	14.00	50	\$486.60	Pcs	
P2380-4	EG	3/8"-16	15.00	50	\$495.50	Pcs	
P2380-5	EG	3/8"-16	16.00	25	\$550.15	Pcs	
P2380-6	EG	3/8"-16	16.00	50	\$613.65	Pcs	
P2381-2	EG	1/2"-13	14.00	100	\$527.25	Pcs	
P2381-3	EG	1/2"-13	15.00	100	\$534.90	Pcs	
P2381-4	EG	1/2"-13	17.00	50	\$559.00	Pcs	
P2381-5	EG	1/2"-13	18.00	50	\$565.35	Pcs	
P2381-6	EG	1/2"-13	19.00	20	\$597.15	Pcs	
P2381-7	EG	1/2"-13	20.00	20	\$635.25	Pcs	
P2382-2	EG	5/8"-11	18.00	25	\$1,251.45	Pcs	
P2382-3	EG	5/8"-11	20.00	20	\$1,264.15	Pcs	

Part No.	Fin.	Wt/100	Std Qty	\$/100	UM	
D 	P2485	EG	3.00	100	\$334.15	Pcs
P2485	SS	3.00	100	CALL	Pcs	

Part No.	Fin.	Wt/100	Std Qty	\$/100	UM	
C 	P2486	EG	16.00	0	\$416.95	Pcs

Part No.	Fin.	Size	Wt/100	Std Qty	\$/100	UM	
C 	P3006-0832	EG	#8-32	6.00	100	\$469.15	Pcs
P3006-1024	EG	#10-24	6.00	100	\$469.15	Pcs	
P3006-1420	EG	1/4"-20	6.00	100	\$147.70	Pcs	
P3006-1420	HG	1/4"-20	7.00	100	\$612.25	Pcs	
P3006U1420	SS	1/4"-20	7.00	100	CALL	Pcs	
P3007	EG	5/16"-18	6.00	100	\$173.00	Pcs	
P3008	EG	3/8"-16	9.00	100	\$161.70	Pcs	
P3008	HG	3/8"-16	10.00	100	\$473.65	Pcs	
P3008U	SS	3/8"-16	10.00	100	CALL	Pcs	
P3009	EG	7/16"-14	9.00	100	\$192.55	Pcs	
P3010	EG	1/2"-13	11.00	100	\$178.55	Pcs	
P3010	HG	1/2"-13	11.00	100	\$458.30	Pcs	
P3010U	SS	1/2"-13	11.00	100	CALL	Pcs	
P3013	EG	1/2"-13	8.00	100	\$179.25	Pcs	

AL-Alum.; CP-Cadmium Plated; EA- Extruded Alum.; EG-Electro-Galv.; EV-Everdur; FG-Fiberglass Reinforced Polyester; GR-Perma-Green; GY-Gray; HG-Hot Dip Galv.; MA-Maple; WH-White; NC-No Closure Strip; W/End Caps and Back Plates; PL-Plain; PG-Pre-Galv.; PO-Porcelain; SS-Stainless 304; ST-Stainless 316; WC-W/Closure Strip, End Caps and Back Plates; X-No Closure Strip or End Caps, W/Back Plates; ZD-Yellow Zinc Dichromate
 Note: For part details and loading information refer to the current Unistrut General Engineering Catalog.

Part No.	Fin.	Size	Wt/100	Std Qty	\$/100 U/M	Part No.	Fin.	Size	Wt/100	Std Qty	\$/100 U/M
----------	------	------	--------	---------	------------	----------	------	------	--------	---------	------------

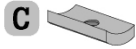

C											
P3016-0632	EG	#6-32	2.00	250	\$295.20						Pcs
P3016-0832	EG	#8-32	2.00	250	\$295.20						Pcs
P3016-1024	EG	#10-24	4.00	250	\$295.20						Pcs
P3016-1420	EG	1/4"-20	4.00	250	\$295.20						Pcs



P4006-0832	EG	#8-32	7.00	100	\$611.70						Pcs
P4006-1024	EG	#10-24	7.00	100	\$611.70						Pcs
P4006-1032	EG	#10-32	7.00	100	\$611.70						Pcs
P4006-1420	EG	1/4"-20	7.00	100	\$188.05						Pcs
P4006-1420	AL	1/4"-20	3.00	100	CALL						Pcs
P4006T1420	SS	1/4"-20	8.00	100	CALL						Pcs
P4006U1420	SS	1/4"-20	7.00	100	CALL						Pcs
P4007	EG	5/16"-18	6.00	100	\$190.70						Pcs
P4007	AL	5/16"-18	3.00	100	CALL						Pcs
P4008	EG	3/8"-16	9.00	100	\$184.70						Pcs
P4008	HG	3/8"-16	9.00	100	\$614.70						Pcs
P4008	AL	3/8"-16	3.00	100	CALL						Pcs
P4009	EG	7/16"-14	9.00	100	\$285.40						Pcs
P4010	EG	1/2"-13	8.00	100	\$200.15						Pcs
P4010	HG	1/2"-13	9.00	100	\$563.50						Pcs
P4010	AL	1/2"-13	3.00	100	CALL						Pcs



P4012	EG	5/8"-11	10.00	100	\$513.40						Pcs
P4023	EG	3/4"-10	10.00	100	\$714.85						Pcs
P4023	SS	3/4"-10	11.00	100	CALL						Pcs



P4012S	EG	5/8"-11	11.00	100	\$1,005.75						Pcs
P4023S	EG	3/4"-10	11.00	100	\$970.45						Pcs
P4023S	SS	3/4"-10	11.00	100	CALL						Pcs



P4908	EG	3/8"	18.00	100	\$336.20						Pcs
P4908	AL	3/8"	8.00	100	CALL						Pcs



P5506-0832	EG	#8-32	7.00	100	\$619.75						Pcs
P5506-1024	EG	#10-24	7.00	100	\$619.75						Pcs
P5506-1420	EG	1/4"-20	7.00	100	\$619.75						Pcs
P5506U1420	SS	1/4"-20	7.00	100	CALL						Pcs
P5507	EG	5/16"-18	7.00	100	\$278.00						Pcs
P5508	EG	3/8"-16	10.00	100	\$293.85						Pcs
P5508U	SS	3/8"-16	10.00	100	CALL						Pcs
P5509	EG	7/16"-14	10.00	100	\$294.75						Pcs
P5510	EG	1/2"-13	12.00	100	\$320.75						Pcs
P5510	HG	1/2"-13	14.00	100	\$628.55						Pcs
P5510U	SS	1/2"-13	12.00	100	CALL						Pcs

AL-Alum.; CP-Cadmium Plated; EA- Extruded Alum.; EG-Electro-Galv.; EV-Everdur; FG-Fiberglass Reinforced Polyester; GR-Perma-Green; GY-Gray; HG-Hot Dip Galv.; MA-Maple; WH-White; NC-No Closure Strip; W/End Caps and Back Plates; PL-Plain; PG-Pre-Galv.; PO-Porcelain; SS-Stainless 304; ST-Stainless 316; WC-W/Closure Strip, End Caps and Back Plates; X-No Closure Strip or End Caps, W/Back Plates; ZD-Yellow Zinc Dichromate
 Note: For part details and loading information refer to the current Unistrut General Engineering Catalog.

Part No. Fin. Size Wt/100 Std Qty \$/100 UM

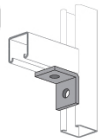
D 

P1026	GR	38.00	50	\$387.85	Pcs
P1026	EG	38.00	50	\$387.85	Pcs
P1026	HG	40.30	50	\$410.60	Pcs
P1026	ZD	38.00	50	\$387.85	Pcs
P1026	AL	11.40	50	CALL	Pcs
P1026	SS	38.00	50	CALL	Pcs

D 

P1028	GR	105.00	20	\$1,562.50	Pcs
P1028	EG	105.00	20	\$1,562.50	Pcs
P1028	HG	111.30	20	\$1,656.05	Pcs
P1028	ZD	105.00	20	\$1,562.50	Pcs

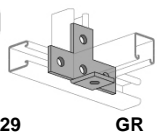
D 

P1029	GR	105.00	10	\$1,608.10	Pcs
P1029	EG	105.00	10	\$1,608.10	Pcs
P1029	HG	111.30	10	\$1,722.35	Pcs

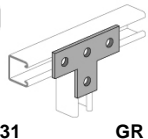
D 

P1031	GR	80.00	25	\$819.60	Pcs
P1031	EG	80.00	25	\$819.60	Pcs
P1031	HG	84.80	25	\$882.65	Pcs
P1031	ZD	80.00	25	\$819.60	Pcs
P1031	AL	30.00	25	CALL	Pcs
P1031	SS	80.00	25	CALL	Pcs

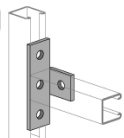
D 

P1033	GR	80.00	25	\$990.05	Pcs
P1033	EG	80.00	25	\$990.05	Pcs
P1033	HG	84.80	25	\$1,009.95	Pcs
P1033	SS	80.00	50	CALL	Pcs

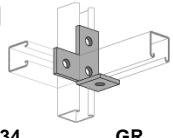
D 

P1034	GR	80.00	25	\$965.35	Pcs
P1034	EG	80.00	25	\$965.35	Pcs
P1034	HG	84.80	25	\$1,127.05	Pcs

Part No. Fin. Size Wt/100 Std Qty \$/100 UM

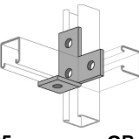
D 

P1035	GR	80.00	25	\$965.35	Pcs
P1035	EG	80.00	25	\$965.35	Pcs
P1035	HG	84.80	25	\$1,127.05	Pcs

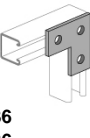
D 

P1036	GR	58.00	50	\$765.30	Pcs
P1036	EG	58.00	50	\$765.30	Pcs
P1036	HG	61.50	50	\$821.10	Pcs
P1036	AL	27.00	50	CALL	Pcs
P1036	SS	58.00	50	CALL	Pcs

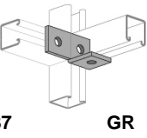
D 

P1037	GR	58.00	25	\$814.40	Pcs
P1037	EG	58.00	25	\$814.40	Pcs
P1037	HG	61.50	25	\$944.45	Pcs
P1037	SS	58.00	25	CALL	Pcs

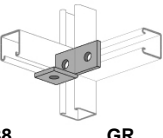
D 

P1038	GR	58.00	25	\$814.40	Pcs
P1038	EG	58.00	25	\$814.40	Pcs
P1038	HG	61.50	25	\$944.45	Pcs
P1038	SS	58.00	25	CALL	Pcs

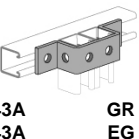
D 

P1043A	GR	105.00	20	\$1,603.95	Pcs
P1043A	EG	105.00	20	\$1,603.95	Pcs
P1043A	HG	111.30	20	\$1,699.70	Pcs

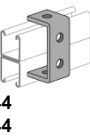
D 

P1044	GR	70.00	25	\$874.90	Pcs
P1044	EG	70.00	25	\$874.90	Pcs
P1044	HG	74.20	25	\$1,034.20	Pcs

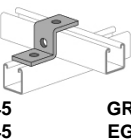
D 

P1045	GR	55.00	50	\$475.30	Pcs
P1045	EG	55.00	50	\$475.30	Pcs
P1045	HG	58.30	50	\$599.45	Pcs
P1045	ZD	55.00	50	\$475.30	Pcs
P1045	SS	55.00	50	CALL	Pcs

AL-Alum.; CP-Cadmium Plated; EA- Extruded Alum.; EG-Electro-Galv.; EV-Everdur; FG-Fiberglass Reinforced Polyester; GR-Perma-Green; GY-Gray; HG-Hot Dip Galv.; MA-Maple; WH-White; NC-No Closure Strip; W/End Caps and Back Plates; PL-Plain; PG-Pre-Galv.; PO-Porcelain; SS-Stainless 304; ST-Stainless 316; WC-W/Closure Strip, End Caps and Back Plates; X-No Closure Strip or End Caps, W/Back Plates; ZD-Yellow Zinc Dichromate
 Note: For part details and loading information refer to the current Unistrut General Engineering Catalog.

Part No. Fin. Size Wt/100 Std Qty \$/100 UM

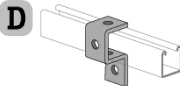

P1046A	GR		76.00	25	\$1,025.50 Pcs
P1046A	EG		7.60	25	\$1,025.50 Pcs
P1046A	HG		80.60	25	\$1,197.75 Pcs
P1046A	ZD		76.00	25	\$1,025.50 Pcs

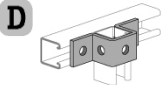

P1047	GR		88.00	25	\$739.55 Pcs
P1047	EG		88.00	25	\$739.55 Pcs
P1047	HG		93.30	25	\$891.45 Pcs
P1047	ZD		88.00	25	\$739.55 Pcs
P1047	AL		34.00	25	CALL Pcs
P1047	SS		88.00	25	CALL Pcs

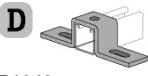

P1048	GR	7-1/4"	105.00	20	\$1,447.55 Pcs
P1048	EG	7-1/4"	105.00	20	\$1,447.55 Pcs
P1048	HG	7-1/4"	111.30	20	\$1,718.20 Pcs
P1049	GR	8-1/2"	120.00	10	\$1,575.55 Pcs
P1049	EG	8-1/2"	120.00	10	\$1,575.55 Pcs
P1050	GR	10-3/8"	130.00	20	\$1,758.25 Pcs
P1050	EG	10-3/8"	130.00	20	\$1,758.25 Pcs
P1050	HG	10-3/8"	137.00	20	\$2,111.55 Pcs

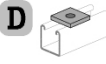

P1062	GR	5/16"	18.00	100	\$398.15 Pcs
P1062	EG	5/16"	18.00	100	\$156.60 Pcs
P1062	HG	16-May	19.10	100	\$188.95 Pcs
P1062	ZD	5/16"	18.00	100	\$156.60 Pcs
P1062	AL	5/16"	6.00	100	CALL Pcs
P1062	SS	5/16"	18.00	100	CALL Pcs
P1062	ST	5/16"	18.00	100	CALL Pcs
P1063	GR	3/8"	18.00	100	\$353.10 Pcs
P1063	EG	3/8"	18.00	100	\$163.10 Pcs
P1063	HG	3/8"	19.10	100	\$197.05 Pcs
P1063	ZD	3/8"	18.00	100	\$163.10 Pcs
P1063	AL	3/8"	6.00	100	CALL Pcs
P1063	SS	3/8"	18.00	100	CALL Pcs
P1063	ST	3/8"	18.00	100	CALL Pcs
P1064	GR	1/2"	17.00	100	\$416.40 Pcs
P1064	EG	1/2"	17.00	100	\$151.05 Pcs
P1064	HG	1/2"	18.00	100	\$185.95 Pcs
P1064	ZD	1/2"	17.00	100	\$151.05 Pcs
P1064	AL	1/2"	6.00	100	CALL Pcs
P1064	SS	1/2"	17.00	100	CALL Pcs
P1064	ST	1/2"	17.00	100	CALL Pcs
P1964	EG	1/2"	16.00	50	\$178.55 Pcs
P1964	HG	1/2"	17.00	50	\$184.10 Pcs
P1964	ZD	1/2"	16.00	100	\$178.55 Pcs
P1964	SS	1/2"	18.00	100	CALL Pcs
P1964	ST	1/2"	18.00	100	CALL Pcs
P2471	EG	3/4"	15.00	100	\$234.35 Pcs
P2471	HG	3/4"	15.90	100	\$260.45 Pcs
P2471	SS	3/4"	15.00	100	CALL Pcs
P2490	EG	7/8"	14.00	100	\$255.70 Pcs

Part No. Fin. Size Wt/100 Std Qty \$/100 UM

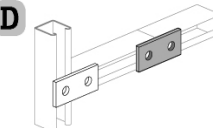

P1065	GR		38.00	50	\$387.85 Pcs
P1065	EG		38.00	50	\$387.85 Pcs
P1065	HG		40.30	50	\$411.55 Pcs
P1065	ZD		38.00	50	\$387.85 Pcs
P1065	AL		14.00	50	CALL Pcs
P1065	SS		38.00	50	CALL Pcs

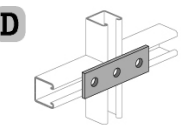

P1066	GR		56.00	25	\$472.05 Pcs
P1066	EG		56.00	25	\$472.05 Pcs
P1066	HG		59.40	25	\$537.55 Pcs
P1066	ZD		56.00	50	\$472.05 Pcs
P1066	AL		26.00	50	CALL Pcs
P1066	SS		56.00	50	CALL Pcs

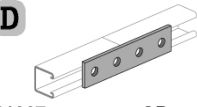

P1067	GR		78.00	25	\$549.45 Pcs
P1067	EG		78.00	25	\$549.45 Pcs
P1067	HG		82.70	25	\$626.80 Pcs
P1067	ZD		78.00	25	\$549.45 Pcs
P1067	AL		34.00	50	CALL Pcs
P1067	SS		78.00	25	CALL Pcs

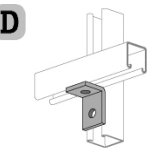

P1068	GR		38.00	50	\$387.85 Pcs
P1068	EG		38.00	50	\$387.85 Pcs
P1068	HG		40.30	50	\$436.15 Pcs
P1068	AL		11.40	50	CALL Pcs
P1068	SS		38.00	100	CALL Pcs



P1075	GR		229.00	20	\$4,076.55 Pcs
P1075	EG		229.00	20	\$4,076.55 Pcs
P1075	HG		242.70	20	\$4,867.15 Pcs

AL-Alum.; CP-Cadmium Plated; EA- Extruded Alum.; EG-Electro-Galv.; EV-Everdur; FG-Fiberglass Reinforced Polyester; GR-Perma-Green; GY-Gray; HG-Hot Dip Galv.; MA-Maple; WH-White; NC-No Closure Strip; W/End Caps and Back Plates; PL-Plain; PG-Pre-Galv.; PO-Porcelain; SS-Stainless 304; ST-Stainless 316; WC-W/Closure Strip, End Caps and Back Plates; X-No Closure Strip or End Caps, W/Back Plates; ZD-Yellow Zinc Dichromate
 Note: For part details and loading information refer to the current Unistrut General Engineering Catalog.

Part No. Fin. Size Wt/100 Std Qty \$/100 UM

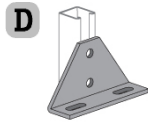

P1130	GR	6-5/8"	190.00	10	\$2,150.50 Pcs
P1130	EG	6-5/8"	190.00	10	\$2,150.50 Pcs
P1130	HG	6-5/8"	201.40	10	\$2,515.80 Pcs
P1131	GR	8-5/8"	242.00	10	\$2,877.80 Pcs
P1131	EG	8-5/8"	242.00	10	\$2,877.80 Pcs
P1131	HG	8-5/8"	256.50	10	\$3,197.40 Pcs
P1131	SS	8-5/8"	242.00	10	CALL Pcs



P1180	EG	P1100	12.00	100	\$424.00 Pcs
P1180	HG	P1100	12.70	100	\$446.40 Pcs
P1180	SS	P1100	12.00	100	CALL Pcs
P1280	EG	P1000	11.00	100	\$327.00 Pcs
P1280	HG	P1000	11.70	100	\$375.85 Pcs
P1280	ZD	P1000	11.00	100	\$327.00 Pcs
P1280	SS	P1000	11.00	100	CALL Pcs
P2280	EG	P2000	11.00	100	\$540.10 Pcs
P4280	EG	P4000	5.00	100	\$419.15 Pcs
P4280	SS	P4000	5.00	100	CALL Pcs
P5280	EG	P5000	22.00	50	\$701.80 Pcs
P5580	EG	P5500	17.00	50	\$572.90 Pcs



P1180W	EG		12.00	100	\$440.05 Pcs
P1280W	EG		11.00	100	\$449.30 Pcs
P1280W	ZD		11.00	100	\$449.30 Pcs
P2280W	EG		11.00	100	\$555.55 Pcs
P5580W	EG		18.00	50	\$604.05 Pcs

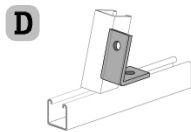

P1186	GR	45°	58.00	25	\$569.20 Pcs
P1186	EG	45°	58.00	25	\$569.20 Pcs
P1186	HG	45°	61.50	25	\$637.55 Pcs
P1186	ZD	45°	58.00	25	\$569.20 Pcs
P1186	SS	45°	58.00	25	CALL Pcs
P2105	GR	82-1/2°	58.00	25	\$632.80 Pcs
P2105	EG	82-1/2°	58.00	25	\$632.80 Pcs
P2105	HG	82-1/2°	61.50	25	\$705.15 Pcs
P2106	GR	75°	58.00	25	\$632.80 Pcs
P2106	EG	75°	58.00	25	\$632.80 Pcs
P2106	HG	75°	61.50	25	\$705.15 Pcs
P2106	ZD	75°	58.00	25	\$632.80 Pcs
P2107	GR	67-1/2°	58.00	25	\$632.80 Pcs
P2107	EG	67-1/2°	58.00	25	\$632.80 Pcs
P2107	HG	67-1/2°	61.50	25	\$705.15 Pcs
P2108	GR	60°	58.00	25	\$632.80 Pcs
P2108	EG	60°	58.00	25	\$632.80 Pcs
P2108	HG	60°	61.50	25	\$705.15 Pcs
P2108	ZD	60°	58.00	25	\$632.80 Pcs
P2108	SS	60°	58.00	25	CALL Pcs
P2109	GR	52-1/2°	58.00	25	\$632.80 Pcs
P2109	EG	52-1/2°	58.00	25	\$632.80 Pcs
P2109	HG	52-1/2°	61.50	25	\$705.15 Pcs
P2110	GR	37-1/2°	58.00	25	\$632.80 Pcs
P2110	EG	37-1/2°	58.00	25	\$632.80 Pcs
P2110	HG	37-1/2°	61.50	25	\$705.15 Pcs
P2110	SS	37-1/2°	58.00	25	CALL Pcs

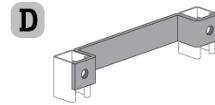

P1201	GR	12" Wide	186.00	10	\$2,171.75 Pcs
P1201	EG	12" Wide	186.00	10	\$2,171.75 Pcs
P1202	GR	15" Wide	221.00	20	\$2,412.80 Pcs
P1202	HG	15" Wide	234.30	20	\$2,699.45 Pcs
P1203	GR	18" Wide	254.00	20	\$2,454.15 Pcs
P1203	HG	18" Wide	269.20	20	\$2,454.15 Pcs

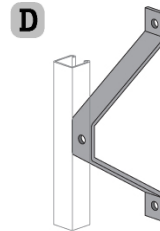

P1204	GR	2-3/8" Deep	113.00	10	\$1,288.85 Pcs
P1204	HG	2-3/8" Deep	119.80	10	\$1,497.10 Pcs
P1204	SS	2-3/8" Deep	113.00	10	CALL Pcs
P1205	GR	4-3/8" Deep	164.00	10	\$1,885.20 Pcs
P1205	EG	4-3/8" Deep	164.00	10	\$1,885.20 Pcs
P1205	HG	4-3/8" Deep	173.80	10	\$2,126.25 Pcs
P1205	SS	4-3/8" Deep	164.00	10	CALL Pcs
P1206	GR	6-3/8" Deep	216.00	10	\$2,608.90 Pcs
P1206	EG	6-3/8" Deep	216.00	10	\$2,608.90 Pcs
P1207	GR	8-3/8" Deep	267.00	10	\$2,659.15 Pcs
P1207	HG	8-3/8" Deep	283.00	10	\$2,866.15 Pcs
P1208	GR	10-3/8" Deep	318.00	10	\$2,804.10 Pcs
P1208	HG	10-3/8" Deep	337.10	10	\$3,696.00 Pcs

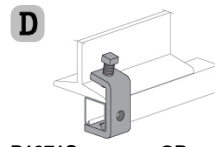

P1271S	GR		95.00	25	\$1,390.50 Pcs
P1271S	EG		95.00	25	\$1,390.50 Pcs
P1271S	HG		100.70	25	\$1,818.65 Pcs
P1271S	SS		95.00	25	CALL Pcs

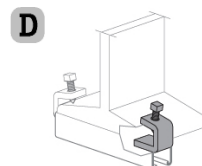

P1272S	GR	Up to 3/4"	39.00	50	\$837.05 Pcs
P1272S	EG	Up to 3/4"	39.00	50	\$837.05 Pcs
P1272S	HG	Up to 3/4"	41.30	50	\$1,078.55 Pcs
P1985S	GR	Up to 3/4"	62.00	20	\$1,217.25 Pcs
P1985S	EG	Up to 3/4"	62.00	20	\$1,217.25 Pcs
P1985S	HG	Up to 3/4"	65.70	20	\$1,577.40 Pcs
P1986S	GR	7/8" to 2"	83.00	25	\$1,257.55 Pcs
P1986S	EG	7/8" to 2"	83.00	25	\$1,257.55 Pcs
P1986S	HG	7/8" to 2"	88.00	25	\$1,639.85 Pcs



P1280A	EG	1/5/08	11.00	20	\$535.70 Pcs
P2280A	EG	1/5/08	11.00	20	\$654.65 Pcs

AL-Alum.; CP-Cadmium Plated; EA- Extruded Alum.; EG-Electro-Galv.; EV-Everdur; FG-Fiberglass Reinforced Polyester; GR-Perma-Green; GY-Gray; HG-Hot Dip Galv.; MA-Maple; WH-White; NC-No Closure Strip; W/End Caps and Back Plates; PL-Plain; PG-Pre-Galv.; PO-Porcelain; SS-Stainless 304; ST-Stainless 316; WC-W/Closure Strip, End Caps and Back Plates; X-No Closure Strip or End Caps, W/Back Plates; ZD-Yellow Zinc Dichromate
 Note: For part details and loading information refer to the current Unistrut General Engineering Catalog.

Part No. Fin. Size Wt/100 Std Qty \$/100 UM

D 

P1280EA	AL	1/5/08	3.50	100	CALL Pcs
P4280EA	AL	13/16	5.00	100	CALL Pcs
P5580EA	AL	2/7/16	5.00	50	CALL Pcs

D 

P1281	GR	3"	49.00	25	\$615.95 Pcs
P1281	EG	3"	49.00	25	\$615.95 Pcs
P1281	HG	3"	51.90	25	\$682.05 Pcs
P1282	GR	3-1/2"	54.00	25	\$635.15 Pcs
P1282	EG	3-1/2"	54.00	25	\$635.15 Pcs
P1282	HG	3-1/2"	57.20	25	\$733.65 Pcs
P1283	GR	4"	61.00	25	\$735.95 Pcs
P1283	EG	4"	61.00	25	\$735.95 Pcs
P1283	HG	4"	64.70	25	\$912.55 Pcs

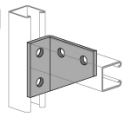
D 

P1290	GR		101.00	25	\$1,432.65 Pcs
P1290	EG		101.00	25	\$1,432.65 Pcs
P1290	HG		107.10	25	\$1,776.15 Pcs
P1290	SS		101.00	25	CALL Pcs

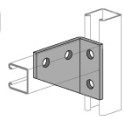
D 

P1291	GR		101.00	25	\$1,432.65 Pcs
P1291	EG		101.00	25	\$1,432.65 Pcs
P1291	HG		107.10	25	\$1,776.15 Pcs
P1291	SS		101.00	25	CALL Pcs

D 

P1315	GR		45.00	25	\$2,192.05 Pcs
P1315	EG		45.00	25	\$2,192.05 Pcs

D 

P1320	GR		63.00	25	\$2,085.70 Pcs
P1320	EG		63.00	25	\$2,085.70 Pcs

Part No. Fin. Size Wt/100 Std Qty \$/100 UM

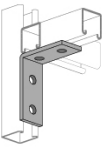
D 

P1325	GR		78.00	25	\$567.70 Pcs
P1325	EG		78.00	25	\$567.70 Pcs
P1325	HG		82.70	25	\$727.65 Pcs
P1325	ZD		78.00	25	\$567.70 Pcs
P1325	AL		23.40	25	CALL Pcs
P1325	SS		78.00	25	CALL Pcs
P1325	ST		78.00	25	CALL Pcs

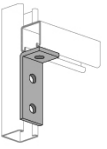
D 

P1326	GR		58.00	50	\$463.85 Pcs
P1326	EG		58.00	50	\$463.85 Pcs
P1326	HG		61.50	50	\$525.85 Pcs
P1326	ZD		58.00	50	\$463.85 Pcs
P1326	SS		58.00	50	CALL Pcs

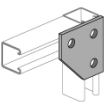
D 

P1334	GR		70.00	25	\$865.55 Pcs
P1334	EG		70.00	25	\$865.55 Pcs
P1334	HG		74.20	25	\$1,030.50 Pcs

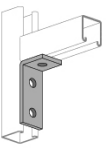
D 

P1346	GR		58.00	50	\$467.20 Pcs
P1346	EG		58.00	50	\$467.20 Pcs
P1346	HG		61.50	50	\$525.85 Pcs
P1346	ZD		58.00	50	\$467.20 Pcs
P1346	SS		58.00	50	CALL Pcs
P1346	ST		58.00	50	CALL Pcs

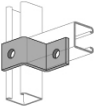
D 

P1347	GR		55.00	25	\$761.25 Pcs
P1347	EG		55.00	25	\$761.25 Pcs
P1347	HG		58.30	25	\$793.35 Pcs
P1347	SS		55.00	25	CALL Pcs

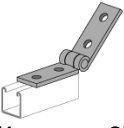
D 

P1354	GR		109.00	25	\$3,420.05 Pcs
P1354	EG		109.00	25	\$3,420.05 Pcs

AL-Alum.; CP-Cadmium Plated; EA- Extruded Alum.; EG-Electro-Galv.; EV-Everdur; FG-Fiberglass Reinforced Polyester; GR-Perma-Green; GY-Gray; HG-Hot Dip Galv.; MA-Maple; WH-White; NC-No Closure Strip; W/End Caps and Back Plates; PL-Plain; PG-Pre-Galv.; PO-Porcelain; SS-Stainless 304; ST-Stainless 316; WC-W/Closure Strip, End Caps and Back Plates; X-No Closure Strip or End Caps, W/Back Plates; ZD-Yellow Zinc Dichromate
 Note: For part details and loading information refer to the current Unistrut General Engineering Catalog.

Part No. Fin. Size Wt/100 Std Qty \$/100 UM

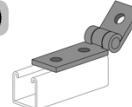

P1354A	EG	109.00	25	\$3,176.00	Pcs
---------------	-----------	--------	----	-------------------	-----

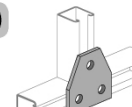

P1356	GR	70.00	25	\$1,024.95	Pcs
P1356	EG	70.00	25	\$1,024.95	Pcs
P1356	HG	74.20	25	\$1,213.20	Pcs
P1356	AL	34.00	25	CALL	Pcs
P1356	SS	70.00	25	CALL	Pcs

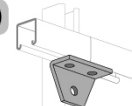

P1357	GR	70.00	25	\$1,074.25	Pcs
P1357	EG	70.00	25	\$1,074.25	Pcs
P1357	HG	74.20	25	\$1,133.15	Pcs
P1357	SS	70.00	25	CALL	Pcs



P1358	GR	105.00	20	\$1,352.15	Pcs
P1358	EG	105.00	20	\$1,352.15	Pcs
P1358	HG	111.30	20	\$1,519.40	Pcs
P1358	SS	105.00	25	CALL	Pcs

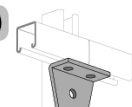

P1359	GR	105.00	25	\$1,438.45	Pcs
P1359	EG	105.00	25	\$1,438.45	Pcs
P1359	HG	111.30	25	\$1,548.05	Pcs
P1359	SS	105.00	25	CALL	Pcs

Part No. Fin. Size Wt/100 Std Qty \$/100 UM

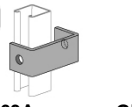

P1363A	GR	4"	78.00	25	\$862.45	Pcs
P1363A	EG	4"	78.00	25	\$862.45	Pcs
P1363A	HG	4"	82.70	25	\$958.20	Pcs
P1363A	SS	4"	76.00	25	CALL	Pcs
P1363B	GR	5"	89.00	25	\$935.20	Pcs
P1363B	EG	5"	89.00	25	\$935.20	Pcs
P1363B	SS	5"	86.00	25	CALL	Pcs
P1363C	GR	6"	101.00	25	\$1,025.50	Pcs
P1363C	EG	6"	101.00	25	\$1,025.50	Pcs
P1363C	HG	6"	107.10	25	\$1,122.30	Pcs
P1363C	SS	6"	101.00	25	CALL	Pcs
P1363D	GR	7"	112.00	25	\$1,082.60	Pcs
P1363D	HG	7"	118.70	25	\$1,236.30	Pcs
P1363D	SS	7"	112.00	25	CALL	Pcs
P1363E	GR	8"	124.00	20	\$1,303.65	Pcs
P1363E	EG	8"	124.00	20	\$1,303.65	Pcs
P1363E	SS	8"	124.00	20	CALL	Pcs

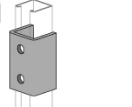

P1376	GR	1/5/08	128.00	25	\$1,206.40	Pcs
P1376	EG	1/5/08	128.00	25	\$1,206.40	Pcs
P1376	HG	1/5/08	135.70	25	\$1,321.80	Pcs
P1376	AL	1/5/08	49.00	25	CALL	Pcs
P1376	SS	1/5/08	118.10	25	CALL	Pcs

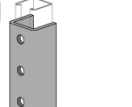

P1376A	GR	1/5/08	197.00	20	\$1,802.70	Pcs
P1376A	EG	1/5/08	197.00	20	\$1,802.70	Pcs
P1376A	HG	1/5/08	208.80	20	\$1,925.15	Pcs
P1376A	SS	1/5/08	197.00	20	CALL	Pcs



P1377	GR	1/5/08	265.00	10	\$2,312.75	Pcs
P1377	EG	1/5/08	265.00	10	\$2,312.75	Pcs
P1377	HG	1/5/08	280.90	10	\$2,604.05	Pcs
P1377	ZD	1/5/08	265.00	10	\$2,312.75	Pcs
P1377	SS	1/5/08	265.00	10	CALL	Pcs
P4377	GR	13/16" And 7/8"	176.00	10	\$1,571.25	Pcs
P4377	EG	13/16" And 7/8"	176.00	10	\$1,571.25	Pcs
P4377	HG	13/16" And 7/8"	176.00	10	\$1,885.40	Pcs
P5077	GR	3-1/4"	380.00	10	\$3,788.85	Pcs
P5077	EG	3-1/4"	380.00	10	\$3,788.85	Pcs
P5577	GR	2-7/16"	294.00	10	\$3,194.95	Pcs
P5577	EG	2-7/16"	294.00	10	\$3,194.95	Pcs

AL-Alum.; CP-Cadmium Plated; EA- Extruded Alum.; EG-Electro-Galv.; EV-Everdur; FG-Fiberglass Reinforced Polyester; GR-Perma-Green; GY-Gray; HG-Hot Dip Galv.; MA-Maple; WH-White; NC-No Closure Strip; W/End Caps and Back Plates; PL-Plain; PG-Pre-Galv.; PO-Porcelain; SS-Stainless 304; ST-Stainless 316; WC-W/Closure Strip, End Caps and Back Plates; X-No Closure Strip or End Caps, W/Back Plates; ZD-Yellow Zinc Dichromate
 Note: For part details and loading information refer to the current Unistrut General Engineering Catalog.

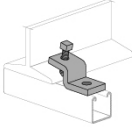
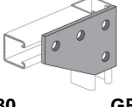
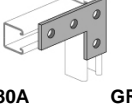
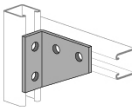
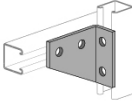
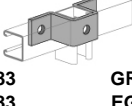
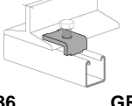
Part No.	Fin.	Size	Wt/100	Std Qty	\$/100 UM
D					
P1379S	GR		75.00	20	\$1,596.80 Pcs
P1379S	EG		75.00	20	\$1,596.80 Pcs
P1379S	HG		79.50	20	\$1,863.00 Pcs
D					
P1380	GR		105.00	20	\$1,103.15 Pcs
P1380	EG		105.00	20	\$1,103.15 Pcs
P1380	HG		111.30	20	\$1,262.30 Pcs
P1380	AL		52.00	20	CALL Pcs
P1380	SS		105.00	20	CALL Pcs
D					
P1380A	GR		80.00	20	\$1,078.10 Pcs
P1380A	EG		80.00	20	\$1,078.10 Pcs
P1380A	HG		84.80	20	\$1,213.00 Pcs
P1380A	ZD		80.00	20	\$1,078.10 Pcs
P1380A	AL		48.00	20	CALL Pcs
P1380A	SS		80.00	20	CALL Pcs
D					
P1381	GR		105.00	25	\$1,471.95 Pcs
P1381	EG		105.00	25	\$1,471.95 Pcs
P1381	HG		111.30	25	\$1,635.35 Pcs
D					
P1382	GR		105.00	25	\$1,471.95 Pcs
P1382	EG		105.00	25	\$1,471.95 Pcs
P1382	HG		111.30	25	\$1,635.35 Pcs
D					
P1383	GR		95.00	25	\$1,313.45 Pcs
P1383	EG		95.00	25	\$1,313.45 Pcs
P1383	HG		100.70	25	\$1,494.70 Pcs
P1383	SS		95.00	25	CALL Pcs
D					
P1386	GR		27.00	50	\$448.60 Pcs
P1386	EG		27.00	50	\$448.60 Pcs
P1386	HG		28.60	50	\$533.85 Pcs
P1386	SS		27.00	50	CALL Pcs

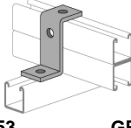
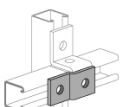
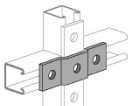
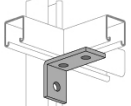
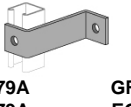
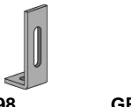
Part No.	Fin.	Size	Wt/100	Std Qty	\$/100 UM
D					
P1453	GR		70.00	25	\$853.55 Pcs
P1453	EG		70.00	25	\$853.55 Pcs
P1453	HG		74.20	25	\$911.55 Pcs
P1453	SS		70.00	25	CALL Pcs
D					
P1454	GR		38.00	25	\$527.85 Pcs
P1454	EG		38.00	25	\$527.85 Pcs
P1454	HG		40.00	25	\$585.95 Pcs
P1454	AL		16.00	25	CALL Pcs
D					
P1455	GR		58.00	20	\$771.65 Pcs
D					
P1458	GR		58.00	50	\$466.25 Pcs
P1458	EG		58.00	50	\$466.25 Pcs
P1458	HG		61.50	50	\$520.90 Pcs
P1458	SS		58.00	50	CALL Pcs
D					
P1479A	GR	4"	81.00	25	\$888.55 Pcs
P1479A	EG	4"	81.00	25	\$888.55 Pcs
P1479B	GR	5"	92.00	25	\$1,025.50 Pcs
P1479B	EG	5"	92.00	25	\$1,025.50 Pcs
P1479C	GR	6"	104.00	25	\$1,078.55 Pcs
P1479C	EG	6"	104.00	25	\$1,078.55 Pcs
P1479C	HG	6"	108.00	25	\$1,216.70 Pcs
P1479D	GR	7"	115.00	25	\$1,135.15 Pcs
P1479D	EG	7"	115.00	25	\$1,135.15 Pcs
P1479E	GR	8"	127.00	25	\$1,291.05 Pcs
P1479E	EG	8"	127.00	25	\$1,291.05 Pcs
D					
P1498	GR	4-7/8"	65.00	25	\$894.80 Pcs
P1498	EG	4-7/8"	65.00	25	\$894.80 Pcs
P1498	HG	4-7/8"	68.90	25	\$955.40 Pcs
P1498	SS	4-7/8"	65.00	25	CALL Pcs
P1498	ST	4-7/8"	65.00	25	CALL Pcs
P1499	GR	6-7/8"	85.00	25	\$1,055.80 Pcs
P1499	EG	6-7/8"	85.00	25	\$1,055.80 Pcs
P1499	HG	6-7/8"	90.10	25	\$1,151.40 Pcs

AL-Alum.; CP-Cadmium Plated; EA- Extruded Alum.; EG-Electro-Galv.; EV-Everdur; FG-Fiberglass Reinforced Polyester; GR-Perma-Green; GY-Gray; HG-Hot Dip Galv.; MA-Maple; WH-White; NC-No Closure Strip; W/End Caps and Back Plates; PL-Plain; PG-Pre-Galv.; PO-Porcelain; SS-Stainless 304; ST-Stainless 316; WC-W/Closure Strip, End Caps and Back Plates; X-No Closure Strip or End Caps, W/Back Plates; ZD-Yellow Zinc Dichromate
 Note: For part details and loading information refer to the current Unistrut General Engineering Catalog.

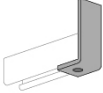
Part No.	Fin.	Size	Wt/100	Std Qty	\$/100	UM
D						
						
P1538A	GR	3-7/8"	61.00	25	\$648.65	Pcs
P1538A	HG	3-7/8"	64.70	25	\$699.60	Pcs
P1538A	SS	3-7/8"	61.00	25	CALL	Pcs
P1538B	GR	5-7/8"	84.00	25	\$814.40	Pcs
P1538B	EG	5-7/8"	84.00	25	\$814.40	Pcs
P1538B	HG	5-7/8"	89.00	25	\$892.35	Pcs
P1538C	GR	7-7/8"	107.00	10	\$1,031.20	Pcs
P1538C	HG	7-7/8"	113.40	10	\$1,157.20	Pcs
P1538D	GR	9-7/8"	130.00	25	\$1,289.65	Pcs
P1538D	EG	9-7/8"	130.00	25	\$1,289.65	Pcs
P1538D	HG	9-7/8"	137.80	25	\$1,373.75	Pcs

Part No.	Fin.	Size	Wt/100	Std Qty	\$/100	UM
D						
						
P1546	GR	45°	58.00	20	\$543.65	Pcs
P1546	EG	45°	58.00	20	\$543.65	Pcs
P1546	HG	45°	61.50	20	\$586.05	Pcs
P1546	ZD	45°	58.00	20	\$543.65	Pcs
P1546	AL	45°	23.00	50	CALL	Pcs
P1546	SS	45°	58.00	20	CALL	Pcs
P2094	GR	82-1/2°	58.00	25	\$632.80	Pcs
P2094	EG	82-1/2°	58.00	25	\$632.80	Pcs
P2094	HG	82-1/2°	61.50	25	\$700.30	Pcs
P2095	GR	75°	58.00	25	\$632.80	Pcs
P2095	EG	75°	58.00	25	\$632.80	Pcs
P2095	HG	75°	61.50	25	\$700.30	Pcs
P2096	GR	67-1/2°	58.00	25	\$626.95	Pcs
P2096	EG	67-1/2°	58.00	25	\$626.95	Pcs
P2096	HG	67-1/2°	61.50	25	\$700.30	Pcs
P2097	GR	60°	58.00	25	\$626.95	Pcs
P2097	EG	60°	58.00	25	\$626.95	Pcs
P2097	HG	60°	61.50	25	\$700.30	Pcs
P2097	ZD	60°	58.00	25	\$626.95	Pcs
P2097	SS	60°	58.00	25	CALL	Pcs
P2098	GR	52-1/2°	58.00	20	\$626.95	Pcs
P2098	EG	52-1/2°	58.00	20	\$626.95	Pcs
P2098	HG	52-1/2°	61.50	20	\$700.30	Pcs
P2099	GR	37-1/2°	58.00	25	\$626.95	Pcs
P2099	EG	37-1/2°	58.00	25	\$626.95	Pcs
P2099	AL	37-1/2°	23.00	25	CALL	Pcs
P2100	GR	37-1/2°	58.00	20	\$626.95	Pcs
P2100	EG	37-1/2°	58.00	20	\$626.95	Pcs
P2100	HG	37-1/2°	61.50	20	\$700.30	Pcs

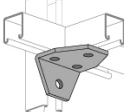
Part No.	Fin.	Size	Wt/100	Std Qty	\$/100	UM
D						
						
P1579	GR		103.00	20	\$1,672.80	Pcs
P1579	HG		109.20	20	\$1,811.85	Pcs

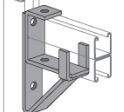
Part No.	Fin.	Size	Wt/100	Std Qty	\$/100	UM
D						
						
P1593	GR		272.00	10	\$4,987.50	Pcs
P1593	EG		272.00	10	\$4,987.50	Pcs
P1593	HG		288.30	10	\$6,234.55	Pcs

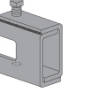
Part No.	Fin.	Size	Wt/100	Std Qty	\$/100	UM
D						
						
P1648S	GR	1/4"-20	67.00	10	\$2,571.85	Pcs
P1648S	EG	1/4"-20	67.00	10	\$2,571.85	Pcs
P1648S	HG	1/4"-20	71.00	10	\$2,946.05	Pcs
P1649AS	GR	3/8"-16	67.00	10	\$2,845.10	Pcs
P1649AS	EG	3/8"-16	67.00	10	\$2,845.10	Pcs
P1649AS	HG	3/8"-16	71.00	10	\$3,219.20	Pcs
P1649S	GR	5/16"-18	67.00	10	\$2,828.15	Pcs
P1649S	EG	5/16"-18	67.00	10	\$2,828.15	Pcs
P1650AS	GR	1/2"-13	100.00	10	\$2,779.50	Pcs
P1650AS	EG	1/2"-13	100.00	10	\$2,779.50	Pcs
P1650AS	HG	1/2"-13	106.00	10	\$3,331.15	Pcs
P1650S	GR	3/8"-16	100.00	10	\$2,871.90	Pcs
P1650S	EG	3/8"-16	100.00	10	\$2,871.90	Pcs
P1650S	HG	3/8"-16	106.00	10	\$3,287.25	Pcs
P1651AS	GR	5/8"-11	130.00	10	\$3,264.05	Pcs
P1651AS	EG	5/8"-11	130.00	10	\$3,264.05	Pcs
P1651AS	HG	5/8"-11	137.80	10	\$3,765.20	Pcs
P1651S	GR	1/2"-13	130.00	10	\$3,170.50	Pcs
P1651S	EG	1/2"-13	130.00	10	\$3,170.50	Pcs
P1651S	HG	1/2"-13	137.80	10	\$3,671.30	Pcs
P1651S	SS	1/2"-13	130.00	25	CALL	Pcs
P1652S	EG	5/8"-11	160.00	10	\$7,252.80	Pcs
P1653S	EG	3/4"-10	160.00	10	\$7,154.05	Pcs
P1653S	HG	3/4"-10	169.60	10	\$7,851.55	Pcs

Part No.	Fin.	Size	Wt/100	Std Qty	\$/100	UM
D						
						
P1654A	GR	6"	26.00	25	\$717.35	Pcs
P1654A	HG	6"	27.30	25	\$777.80	Pcs
P1655A	GR	9"	35.00	50	\$800.05	Pcs
P1655A	HG	9"	36.80	50	\$837.05	Pcs
P1656A	GR	6"	37.00	20	\$498.85	Pcs
P1656A	HG	6"	39.20	20	\$540.65	Pcs
P1657A	EG	9"	34.00	50	\$529.70	Pcs
P1657A	HG	9"	52.30	20	\$570.35	Pcs
P1658A	GR	12"	61.00	20	\$573.00	Pcs
P1658A	EG	12"	44.00	20	\$573.00	Pcs
P1658A	HG	12"	65.30	20	\$609.85	Pcs
P1659A	HG	6"	39.20	20	\$644.35	Pcs
P1660A	GR	9"	49.00	20	\$658.95	Pcs

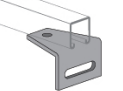
Part No.	Fin.	Size	Wt/100	Std Qty	\$/100	UM
D						
						
P1713	GR		97.00	20	\$1,507.85	Pcs
P1713	EG		97.00	20	\$1,507.85	Pcs
P1713	HG		102.80	20	\$1,608.20	Pcs

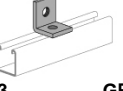
Part No.	Fin.	Size	Wt/100	Std Qty	\$/100	UM
D						
						
P1723	GR		34.00	50	\$767.95	Pcs
P1723	EG		34.00	50	\$767.95	Pcs
P1723	HG		36.00	50	\$1,087.45	Pcs

AL-Alum.; CP-Cadmium Plated; EA- Extruded Alum.; EG-Electro-Galv.; EV-Everdur; FG-Fiberglass Reinforced Polyester; GR-Perma-Green; GY-Gray; HG-Hot Dip Galv.; MA-Maple; WH-White; NC-No Closure Strip; W/End Caps and Back Plates; PL-Plain; PG-Pre-Galv.; PO-Porcelain; SS-Stainless 304; ST-Stainless 316; WC-W/Closure Strip, End Caps and Back Plates; X-No Closure Strip or End Caps, W/Back Plates; ZD-Yellow Zinc Dichromate
 Note: For part details and loading information refer to the current Unistrut General Engineering Catalog.

Part No. Fin. Size Wt/100 Std Qty \$/100 UM

D

P1726	GR		148.00	20	\$2,177.50	Pcs
P1726	EG		148.00	10	\$2,177.50	Pcs
P1726	HG		156.90	20	\$2,722.90	Pcs
P1726	ZD		148.00	20	\$2,177.50	Pcs
P1726	ST		148.00	20	CALL	Pcs

D

P1727	GR		154.00	10	\$2,262.05	Pcs
P1727	EG		154.00	10	\$2,262.05	Pcs
P1727	HG		163.20	10	\$2,827.10	Pcs
P1727	AL		62.00	25	CALL	Pcs
P1727	SS		154.00	50	CALL	Pcs
P1727	ST		154.00	50	CALL	Pcs

D

P1728	GR		154.00	20	\$2,322.45	Pcs
P1728	EG		154.00	10	\$2,322.45	Pcs
P1728	HG		163.20	20	\$2,901.95	Pcs

D

P1730	GR		54.00	25	\$915.20	Pcs
P1730	EG		54.00	25	\$915.20	Pcs

D

P1732	GR		88.00	20	\$1,390.40	Pcs
P1732	EG		88.00	20	\$1,390.40	Pcs
P1732	HG		93.00	25	\$1,824.80	Pcs

D

P1734	GR		70.00	25	\$1,363.95	Pcs
P1734	EG		70.00	25	\$1,363.95	Pcs

Part No. Fin. Size Wt/100 Std Qty \$/100 UM

D

P1736	GR		70.00	25	\$980.00	Pcs
P1736	EG		70.00	25	\$980.00	Pcs
P1736	HG		74.20	25	\$1,014.20	Pcs

D

P1737	GR		128.00	50	\$1,516.65	Pcs
P1737	EG		128.00	50	\$1,516.65	Pcs
P1737	HG		135.70	50	\$1,727.40	Pcs
P1737	ZD		128.00	25	\$1,516.65	Pcs
P1737	SS		128.00	25	CALL	Pcs

D

P1747	GR		66.00	25	\$829.40	Pcs
P1747	EG		66.00	25	\$829.40	Pcs
P1747	HG		70.00	25	\$871.45	Pcs
P1747	AL		23.00	25	CALL	Pcs

D

P1750	GR		38.00	50	\$618.75	Pcs
P1750	EG		38.00	50	\$618.75	Pcs
P1750	HG		40.30	50	\$687.90	Pcs
P1750	SS		38.00	50	CALL	Pcs

D

P1769	GR	8-1/2"	174.00	20	\$4,067.70	Pcs
P1769	EG	8-1/2"	174.00	20	\$4,067.70	Pcs
P1769	HG	8-1/2"	184.40	20	\$4,429.45	Pcs

D

P1771	GR	10-1/2"	206.00	20	\$4,350.65	Pcs
P1771	EG	10-1/2"	206.00	20	\$4,350.65	Pcs
P1771	HG	10-1/2"	218.40	20	\$4,217.85	Pcs

D

P1773	GR	12-1/2"	264.00	10	\$4,909.20	Pcs
P1773	HG	12-1/2"	279.80	10	\$5,170.15	Pcs

AL-Alum.; CP-Cadmium Plated; EA- Extruded Alum.; EG-Electro-Galv.; EV-Everdur; FG-Fiberglass Reinforced Polyester; GR-Perma-Green; GY-Gray; HG-Hot Dip Galv.; MA-Maple; WH-White; NC-No Closure Strip; W/End Caps and Back Plates; PL-Plain; PG-Pre-Galv.; PO-Porcelain; SS-Stainless 304; ST-Stainless 316; WC-W/Closure Strip, End Caps and Back Plates; X-No Closure Strip or End Caps, W/Back Plates; ZD-Yellow Zinc Dichromate
 Note: For part details and loading information refer to the current Unistrut General Engineering Catalog.

Part No. Fin. Size Wt/100 Std Qty \$/100 UM

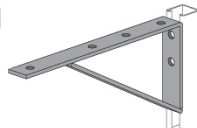
D 

P1775	GR	14-1/2"	295.00	10	\$5,797.85 Pcs
P1775	EG	14-1/2"	295.00	10	\$5,797.85 Pcs
P1775	HG	14-1/2"	312.70	10	\$5,263.55 Pcs

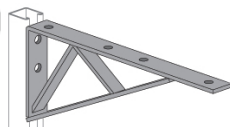
D 

P1777	GR	16-1/2"	385.00	5	\$7,540.75 Pcs
P1777	EG	16-1/2"	385.00	5	\$7,540.75 Pcs
P1777	HG	16-1/2"	408.10	5	\$8,176.35 Pcs

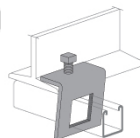
D 

P1796S	GR	1-5/8"	103.00	50	\$1,508.90 Pcs
P1796S	EG	1-5/8"	103.00	50	\$1,508.90 Pcs
P1796S	HG	1-5/8"	91.20	25	\$1,842.70 Pcs
P1796S	SS	1-5/8"	86.00	50	CALL Pcs

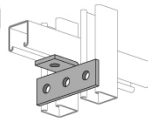
D 

P1821	GR		71.00	20	\$1,716.80 Pcs
P1821	EG		71.00	20	\$1,716.80 Pcs
P1821	HG		75.30	20	\$1,780.80 Pcs

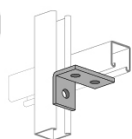
D 

P1822	GR		55.00	25	\$1,070.90 Pcs
P1822	EG		55.00	25	\$1,070.90 Pcs
P1822	HG		58.30	25	\$1,124.30 Pcs

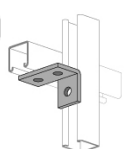
D 

P1823	GR		55.00	25	\$1,070.90 Pcs
P1823	EG		55.00	25	\$1,070.90 Pcs
P1823	HG		58.30	25	\$1,124.30 Pcs

Part No. Fin. Size Wt/100 Std Qty \$/100 UM

D 

P1834	GR		102.00	25	\$1,809.90 Pcs
P1834	EG		102.00	25	\$1,809.90 Pcs
P1834	HG		108.10	25	\$1,962.80 Pcs

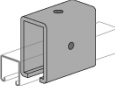
D 

P1834A	GR		220.00	10	\$2,639.30 Pcs
P1834A	EG		220.00	10	\$2,639.30 Pcs
P1834A	HG		233.20	10	\$2,742.65 Pcs

D 

P1843	GR		68.00	20	\$3,188.25 Pcs
P1843	EG		68.00	20	\$3,188.25 Pcs

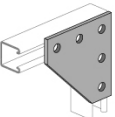
D 

P1873	GR		150.00	20	\$1,651.05 Pcs
P1873	EG		150.00	20	\$1,651.05 Pcs
P1873	HG		159.00	20	\$1,792.70 Pcs

D 

P1887	GR		297.00	10	\$4,025.40 Pcs
P1887	EG		297.00	10	\$4,025.40 Pcs
P1887	HG		314.80	10	\$4,281.25 Pcs
P1887	SS		297.00	10	CALL Pcs

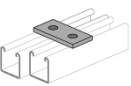
D 

P1924	GR		35.00	50	\$387.75 Pcs
P1924	EG		35.00	50	\$387.75 Pcs
P1924	HG		37.10	50	\$413.25 Pcs
P1924	ZD		35.00	50	\$387.75 Pcs
P1924	AL		13.00	50	CALL Pcs

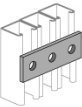
D 

P1925	GR		50.00	25	\$705.60 Pcs
P1925	EG		50.00	25	\$705.60 Pcs
P1925	HG		53.00	25	\$881.60 Pcs
P1925	SS		50.00	25	CALL Pcs

AL-Alum.; CP-Cadmium Plated; EA- Extruded Alum.; EG-Electro-Galv.; EV-Everdur; FG-Fiberglass Reinforced Polyester; GR-Perma-Green; GY-Gray; HG-Hot Dip Galv.; MA-Maple; WH-White; NC-No Closure Strip; W/End Caps and Back Plates; PL-Plain; PG-Pre-Galv.; PO-Porcelain; SS-Stainless 304; ST-Stainless 316; WC-W/Closure Strip, End Caps and Back Plates; X-No Closure Strip or End Caps, W/Back Plates; ZD-Yellow Zinc Dichromate
 Note: For part details and loading information refer to the current Unistrut General Engineering Catalog.

Part No. Fin. Size Wt/100 Std Qty \$/100 UM

D					
P1934	GR		75.00	20	\$950.35 Pcs
P1934	EG		75.00	20	\$950.35 Pcs
P1934	HG		79.50	20	\$1,188.05 Pcs

D					
P1941	GR		94.00	50	\$871.10 Pcs
P1941	EG		94.00	50	\$871.10 Pcs
P1941	HG		99.60	50	\$939.60 Pcs

D					
P1944	GR		220.00	20	\$3,466.85 Pcs
P1944	EG		240.00	20	\$3,466.85 Pcs
P1944	HG		233.20	20	\$3,992.35 Pcs

D					
P1950	GR		240.00	10	\$3,216.45 Pcs
P1950	EG		240.00	10	\$3,216.45 Pcs
P1950	HG		254.40	10	\$3,470.55 Pcs
P1950	ST		240.00	10	CALL Pcs

D					
P1953	GR		176.00	10	\$1,948.35 Pcs
P1953	EG		176.00	10	\$1,948.35 Pcs
P1953	HG		186.60	10	\$2,124.15 Pcs
P1953	SS		176.00	10	CALL Pcs

D					
P1956	GR		230.00	10	\$5,234.25 Pcs
P1956	EG		230.00	10	\$5,234.25 Pcs
P1956	HG		243.80	10	\$5,395.70 Pcs

Part No. Fin. Size Wt/100 Std Qty \$/100 UM

D					
P1957	GR		230.00	10	\$5,234.25 Pcs
P1957	EG		230.00	10	\$5,234.25 Pcs
P1957	HG		243.80	10	\$5,395.70 Pcs

D					
P1959	EG	3/8"-16	21.00	50	\$452.40 Pcs
P1960	EG	1/2"-13	20.00	50	\$452.40 Pcs
P1961	EG	5/8"-11	19.00	50	\$452.40 Pcs

D					
P1962	GR		112.00	50	\$1,177.85 Pcs
P1962	EG		112.00	50	\$1,177.85 Pcs

D					
P1973	GR		53.00	25	\$834.95 Pcs
P1973	HG		56.20	25	\$872.15 Pcs

D					
		Std			
		SQ			
P2072	GR		307.00	10	\$3,669.55 Pcs
P2072	EG		307.00	10	\$3,669.55 Pcs
P2072	HG		325.40	10	\$4,099.90 Pcs
P2072	SS		307.00	10	CALL Pcs
P2072SQ	GR	SQ	307.00	10	\$4,077.25 Pcs
P2072SQ	EG	SQ	307.00	10	\$4,077.25 Pcs
P2072SQ	HG	SQ	325.40	10	\$4,555.45 Pcs

D					
		Std			
		SQ			
P2072A	GR	STD	373.00	10	\$4,310.70 Pcs
P2072A	EG	STD	373.00	10	\$4,310.70 Pcs
P2072A	HG	STD	395.40	10	\$4,855.85 Pcs
P2072A	ZD	STD	337.00	10	\$4,310.70 Pcs
P2072A	AL	STD	135.00	10	CALL Pcs
P2072A	SS	STD	373.00	10	CALL Pcs
P2072A	ST	STD	373.00	10	CALL Pcs
P2072ASQ	GR	SQ	373.00	10	\$4,789.10 Pcs
P2072ASQ	EG	SQ	373.00	10	\$4,789.10 Pcs
P2072ASQ	HG	SQ	395.40	10	\$5,395.00 Pcs
P2072ASQ	AL	SQ	0.00	10	CALL Pcs
P2072ASQ	SS	SQ	373.00	10	CALL Pcs
P2072ASQ	ST	SQ	373.00	20	CALL Pcs

AL-Alum.; CP-Cadmium Plated; EA- Extruded Alum.; EG-Electro-Galv.; EV-Everdur; FG-Fiberglass Reinforced Polyester; GR-Perma-Green; GY-Gray; HG-Hot Dip Galv.; MA-Maple; WH-White; NC-No Closure Strip; W/End Caps and Back Plates; PL-Plain; PG-Pre-Galv.; PO-Porcelain; SS-Stainless 304; ST-Stainless 316; WC-W/Closure Strip, End Caps and Back Plates; X-No Closure Strip or End Caps, W/Back Plates; ZD-Yellow Zinc Dichromate
 Note: For part details and loading information refer to the current Unistrut General Engineering Catalog.

Part No.	Fin.	Size	Wt/100	Std Qty	\$/100	UM
D						
P2073	GR	STD	325.00	10	\$4,162.15	Pcs
P2073	EG	STD	325.00	10	\$4,162.15	Pcs
P2073	HG	STD	344.50	10	\$4,541.45	Pcs
P2073	SS	STD	325.00	10	CALL	Pcs
P2073SQ	GR	SQ	325.00	10	\$4,162.15	Pcs
P2073SQ	HG	SQ	344.50	10	\$4,541.45	Pcs
P2073SQ	SS	SQ	325.00	10	CALL	Pcs

Part No.	Fin.	Size	Wt/100	Std Qty	\$/100	UM
D						
P2073A	GR	STD	408.00	10	\$5,292.55	Pcs
P2073A	EG	STD	408.00	10	\$5,292.55	Pcs
P2073A	HG	STD	432.50	10	\$5,864.75	Pcs
P2073A	AL	STD	163.00	10	CALL	Pcs
P2073A	SS	STD	408.00	10	CALL	Pcs
P2073A	ST	STD	408.00	10	CALL	Pcs
P2073ASQ	GR	SQ	408.00	10	\$5,880.45	Pcs
P2073ASQ	EG	SQ	408.00	10	\$5,292.55	Pcs
P2073ASQ	HG	SQ	432.50	10	\$5,864.75	Pcs
P2073ASQ	AL	SQ	163.00	10	CALL	Pcs
P2073ASQ	SS	SQ	408.00	10	CALL	Pcs
P2073ASQ	ST	SQ	408.00	10	CALL	Pcs

Part No.	Fin.	Wt/100	Std Qty	\$/100	UM
D					
P2079	GR	73.00	20	\$884.50	Pcs
P2079	EG	73.00	20	\$884.50	Pcs
P2079	HG	77.40	20	\$886.80	Pcs
P2079	SS	80.00	20	CALL	Pcs

Part No.	Fin.	Size	Wt/100	Std Qty	\$/100	UM
D						
P2101	GR	30°	58.00	25	\$626.95	Pcs
P2101	EG	30°	58.00	25	\$626.95	Pcs
P2101	HG	30°	61.50	25	\$700.30	Pcs
P2101	SS	30°	58.00	25	CALL	Pcs
P2102	GR	22-1/2°	58.00	25	\$626.95	Pcs
P2102	EG	22-1/2°	58.00	25	\$626.95	Pcs
P2102	HG	22-1/2°	61.50	25	\$700.30	Pcs
P2102	SS	22-1/2°	58.00	25	CALL	Pcs
P2103	GR	15°	58.00	25	\$626.95	Pcs
P2103	EG	15°	58.00	25	\$626.95	Pcs
P2103	HG	15°	61.50	25	\$700.30	Pcs
P2103	SS	15°	58.00	25	CALL	Pcs
P2104	GR	7-1/2°	58.00	25	\$626.95	Pcs
P2104	EG	7-1/2°	55.00	25	\$626.95	Pcs
P2104	HG	7-1/2°	61.50	25	\$700.30	Pcs
P2104	SS	7-1/2°	58.00	25	CALL	Pcs

Part No.	Fin.	Size	Wt/100	Std Qty	\$/100	UM
D						
Cable Entrance Tube						
P21H 20	HG	20 ft. len.	318.00	400	\$2,851.70	Ft

Part No.	Fin.	Wt/100	Std Qty	\$/100	UM
D					
P2223	GR	76.00	25	\$1,091.15	Pcs
P2223	EG	76.00	25	\$1,091.15	Pcs
P2223	HG	80.60	25	\$1,195.30	Pcs
P2223	ZD	76.00	25	\$1,091.15	Pcs
P2223	AL	28.00	25	CALL	Pcs

Part No.	Fin.	Wt/100	Std Qty	\$/100	UM
D					
P2224	GR	115.00	20	\$1,432.65	Pcs
P2224	EG	115.00	10	\$1,432.65	Pcs
P2224	HG	121.90	20	\$1,574.05	Pcs

Part No.	Fin.	Wt/100	Std Qty	\$/100	UM
D					
P2225	GR	155.00	20	\$1,930.35	Pcs
P2225	EG	155.00	10	\$1,930.35	Pcs
P2225	HG	164.30	20	\$2,072.55	Pcs
P2225	ZD	155.00	20	\$1,930.35	Pcs

Part No.	Fin.	Wt/100	Std Qty	\$/100	UM
D					
P2226	GR	217.00	10	\$5,626.80	Pcs
P2226	EG	217.00	20	\$5,626.80	Pcs
P2226	HG	230.00	10	\$5,940.50	Pcs

Part No.	Fin.	Wt/100	Std Qty	\$/100	UM
D					
P2227	GR	113.00	20	\$1,658.95	Pcs
P2227	EG	113.00	10	\$1,658.95	Pcs
P2227	HG	119.80	20	\$1,916.60	Pcs

AL-Alum.; CP-Cadmium Plated; EA- Extruded Alum.; EG-Electro-Galv.; EV-Everdur; FG-Fiberglass Reinforced Polyester; GR-Perma-Green; GY-Gray; HG-Hot Dip Galv.; MA-Maple; WH-White; NC-No Closure Strip; W/End Caps and Back Plates; PL-Plain; PG-Pre-Galv.; PO-Porcelain; SS-Stainless 304; ST-Stainless 316; WC-W/Closure Strip, End Caps and Back Plates; X-No Closure Strip or End Caps, W/Back Plates; ZD-Yellow Zinc Dichromate
 Note: For part details and loading information refer to the current Unistrut General Engineering Catalog.

Part No. Fin. Size Wt/100 Std Qty \$/100 UM

D					
P2228	GR		177.00	20	\$2,280.20 Pcs
P2228	EG		177.00	10	\$2,280.20 Pcs
P2228	HG		187.60	20	\$2,429.30 Pcs

D					
P2229	GR		230.00	10	\$3,513.75 Pcs
P2229	EG		230.00	10	\$3,513.75 Pcs
P2229	HG		243.80	10	\$4,391.20 Pcs

D					
P2230	GR		310.00	10	\$7,847.30 Pcs
P2230	EG		310.00	10	\$7,847.30 Pcs
P2230	HG		328.60	10	\$8,294.85 Pcs

D					
P2231	GR	6"	191.00	20	\$4,135.35 Pcs
P2231	PG	6"	191.00	20	\$4,135.35 Pcs
P2231	HG	6"	202.50	20	\$4,318.80 Pcs
P2231	SS	6"	191.00	20	CALL Pcs
P2232	GR	12"	292.00	20	\$4,679.95 Pcs
P2232	PG	12"	292.00	20	\$4,679.95 Pcs
P2232	HG	12"	309.50	20	\$5,133.05 Pcs
P2232	AL	12"	290.00	20	CALL Pcs
P2232	SS	12"	292.00	20	CALL Pcs

D					
P2231A	GR	6"	191.00	20	\$4,135.35 Pcs
P2232A	GR	12"	292.00	20	\$4,679.95 Pcs
P2232A	PG	12"	292.00	20	\$4,679.95 Pcs
P2232A	HG	12"	309.50	20	\$5,133.05 Pcs

Part No. Fin. Size Wt/100 Std Qty \$/100 UM

D					
P2233	GR	18"	436.00	5	\$5,383.55 Pcs
P2233	PG	18"	436.00	5	\$5,383.55 Pcs
P2233	HG	18"	462.20	5	\$5,466.50 Pcs
P2233	SS	18"	436.00	5	CALL Pcs
P2234	GR	24"	536.00	10	\$6,009.00 Pcs
P2234	PG	24"	536.00	10	\$6,009.00 Pcs
P2234	HG	24"	568.20	10	\$6,283.65 Pcs
P2234	AL	24"	214.00	10	CALL Pcs
P2234	SS	24"	536.00	10	CALL Pcs





D					
P2233A	GR	18"	436.00	5	\$5,383.55 Pcs
P2233A	HG	18"	462.20	5	\$5,466.50 Pcs
P2234A	GR	24"	536.00	10	\$6,009.00 Pcs
P2234A	PG	24"	1181.00	10	\$5,990.40 Pcs
P2234A	HG	24"	568.20	10	\$6,283.65 Pcs
P2234A	SS	24"	536.00	10	CALL Pcs





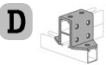

D					
P2235	GR		135.00	10	\$1,885.20 Pcs
P2235	EG		135.00	10	\$1,885.20 Pcs
P2235	HG		143.10	10	\$2,017.10 Pcs

D					
P2237	EG		18.00	50	\$1,008.65 Pcs
P2237	HG		19.10	50	\$1,049.30 Pcs
P2237	SS		18.00	50	CALL Pcs

D					
P2245	GR		315.00	20	\$7,328.35 Pcs
P2245	EG		315.00	20	\$7,328.35 Pcs
P2245	HG		333.90	20	\$7,595.15 Pcs
P2245	SS		315.00	20	CALL Pcs

AL-Alum.; CP-Cadmium Plated; EA- Extruded Alum.; EG-Electro-Galv.; EV-Everdur; FG-Fiberglass Reinforced Polyester; GR-Perma-Green; GY-Gray; HG-Hot Dip Galv.; MA-Maple; WH-White; NC-No Closure Strip; W/End Caps and Back Plates; PL-Plain; PG-Pre-Galv.; PO-Porcelain; SS-Stainless 304; ST-Stainless 316; WC-W/Closure Strip, End Caps and Back Plates; X-No Closure Strip or End Caps, W/Back Plates; ZD-Yellow Zinc Dichromate
 Note: For part details and loading information refer to the current Unistrut General Engineering Catalog.

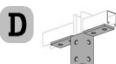
Part No.	Fin.	Size	W/100	Std Qty	\$/100	UM
						
P2260	GR	7-1/2°	78.00	0	\$666.30	Pcs
P2260	EG	7-1/2°	78.00	0	\$666.30	Pcs
P2260	HG	7-1/2°	78.00	0	\$745.20	Pcs
P2261	GR	15°	78.00	0	\$666.30	Pcs
P2261	EG	15°	78.00	0	\$666.30	Pcs
P2261	HG	15°	78.00	0	\$745.20	Pcs
P2262	GR	22-1/2°	78.00	0	\$666.30	Pcs
P2262	EG	22-1/2°	78.00	0	\$666.30	Pcs
P2262	HG	22-1/2°	78.00	0	\$745.20	Pcs
P2263	GR	30°	78.00	0	\$666.30	Pcs
P2263	EG	30°	78.00	0	\$666.30	Pcs
P2263	HG	30°	78.00	0	\$745.20	Pcs
P2264	GR	37-1/2°	78.00	0	\$666.30	Pcs
P2264	EG	37-1/2°	78.00	0	\$666.30	Pcs
P2264	HG	37-1/2°	78.00	0	\$745.20	Pcs
P2265	GR	45°	78.00	0	\$666.30	Pcs
P2265	EG	45°	78.00	0	\$666.30	Pcs
P2265	HG	45°	78.00	0	\$745.20	Pcs
P2266	GR	52-1/2°	78.00	0	\$666.30	Pcs
P2266	EG	52-1/2°	78.00	0	\$666.30	Pcs
P2267	EG	60°	78.00	0	\$666.30	Pcs
P2267	HG	60°	78.00	0	\$745.20	Pcs
P2268	EG	67-1/2°	78.00	0	\$666.30	Pcs
P2269	GR	75°	78.00	0	\$666.30	Pcs
P2269	EG	75°	78.00	0	\$666.30	Pcs
P2269	HG	75°	78.00	0	\$745.20	Pcs
P2270	EG	82-1/2°	78.00	0	\$666.30	Pcs
						
P2324	GR		75.00	25	\$1,259.40	Pcs
P2324	EG		75.00	25	\$1,259.40	Pcs
P2324	HG		79.50	25	\$1,363.25	Pcs
P2324	SS		75.00	25	CALL	Pcs
						
P2325	GR		55.00	25	\$719.90	Pcs
P2325	EG		55.00	25	\$719.90	Pcs
P2325	HG		58.30	25	\$769.35	Pcs
						
P2326	GR		171.00	10	\$3,051.40	Pcs
P2326	EG		171.00	10	\$3,051.40	Pcs
P2326	HG		181.30	10	\$3,112.75	Pcs
P2326	AL		75.00	50	CALL	Pcs
P2326	SS		197.00	10	CALL	Pcs
						
P2328	GR		209.00	10	\$3,472.30	Pcs
P2328	EG		209.00	10	\$3,472.30	Pcs
P2328	HG		221.50	10	\$3,653.75	Pcs
P2328	SS		209.00	10	CALL	Pcs
						
P2329	GR		257.00	10	\$3,981.65	Pcs
P2329	EG		257.00	10	\$3,981.65	Pcs
P2329	HG		272.40	10	\$4,061.10	Pcs
P2329	SS		257.00	10	CALL	Pcs

Part No.	Fin.	Size	W/100	Std Qty	\$/100	UM
						
P2341L	GR	L	60.00	20	\$1,312.75	Pcs
P2341L	EG	L	60.00	20	\$1,312.75	Pcs
P2341L	HG	L	63.60	20	\$1,458.20	Pcs
P2341L	ZD	L	60.00	20	\$1,312.75	Pcs
P2341R	GR	R	60.00	20	\$1,312.75	Pcs
P2341R	EG	R	60.00	20	\$1,312.75	Pcs
P2341R	HG	R	63.60	20	\$1,458.20	Pcs
P2341R	ZD	R	60.00	20	\$1,312.75	Pcs
						
P2343L	GR	L	119.00	20	\$1,687.70	Pcs
P2343L	EG	L	119.00	20	\$1,687.70	Pcs
P2343L	HG	L	126.10	20	\$1,793.85	Pcs
P2343R	GR	R	119.00	20	\$1,687.70	Pcs
P2343R	EG	R	119.00	20	\$1,687.70	Pcs
P2343R	HG	R	126.10	20	\$1,793.85	Pcs
						
P2344L	GR	L	176.00	10	\$4,272.70	Pcs
P2344L	EG	L	176.00	10	\$4,272.70	Pcs
P2344L	HG	L	186.60	10	\$4,609.95	Pcs
P2344L	SS	L	176.00	10	CALL	Pcs
P2344R	GR	R	176.00	10	\$4,272.70	Pcs
P2344R	EG	R	176.00	10	\$4,272.70	Pcs
P2344R	HG	R	186.60	10	\$4,609.95	Pcs
P2344R	SS	R	176.00	10	CALL	Pcs
						
P2345	GR		93.00	20	\$1,726.60	Pcs
P2345	EG		93.00	20	\$1,726.60	Pcs
P2345	HG		98.60	20	\$1,805.60	Pcs
P2345	ZD		93.00	20	\$1,726.60	Pcs
						
P2346	GR		150.00	25	\$2,253.05	Pcs
P2346	EG		150.00	25	\$2,253.05	Pcs
P2346	HG		159.00	25	\$2,351.00	Pcs
P2346	ZD		150.00	25	\$2,253.05	Pcs
P2346	SS		150.00	25	CALL	Pcs
						
P2347	GR		193.00	10	\$3,190.90	Pcs
P2347	EG		193.00	10	\$3,190.90	Pcs
P2347	HG		204.60	10	\$3,293.00	Pcs
						
P2348	GR		274.00	10	\$6,567.55	Pcs
P2348	EG		274.00	10	\$6,567.55	Pcs
P2348	HG		290.40	10	\$6,709.40	Pcs
P2348	SS		274.00	10	CALL	Pcs

AL-Alum.; CP-Cadmium Plated; EA- Extruded Alum.; EG-Electro-Galv.; EV-Everdur; FG-Fiberglass Reinforced Polyester; GR-Perma-Green; GY-Gray; HG-Hot Dip Galv.; MA-Maple; WH-White; NC-No Closure Strip; W/End Caps and Back Plates; PL-Plain; PG-Pre-Galv.; PO-Porcelain; SS-Stainless 304; ST-Stainless 316; WC-W/Closure Strip, End Caps and Back Plates; X-No Closure Strip or End Caps, W/Back Plates; ZD-Yellow Zinc Dichromate
 Note: For part details and loading information refer to the current Unistrut General Engineering Catalog.

Part No.	Fin.	Size	W/100	Std Qty	\$/100	UM
						
P2354L	GR	For 1-1/4" Pipe	220.00	10	\$3,509.00	Pcs
P2354L	EG	For 1-1/4" Pipe	220.00	10	\$3,509.00	Pcs
P2354R	GR	For 1-1/4" Pipe	220.00	10	\$3,509.00	Pcs
P2354R	EG	For 1-1/4" Pipe x R	220.00	10	\$3,509.00	Pcs
P2355L	EG	For 2" Pipe	220.00	10	\$3,646.90	Pcs
P2355R	GR	For 2" Pipe	252.00	10	\$3,646.90	Pcs
P2355R	EG	For 2" Pipe	252.00	10	\$3,646.90	Pcs

	EG		9.00	100	\$439.50	Pcs
---	-----------	--	------	-----	-----------------	-----

						
P2398S	EG	1/4"-20	109.00	10	\$3,381.95	Pcs
P2401S	GR	3/8"-16	156.00	10	\$4,164.45	Pcs
P2401S	EG	3/8"-16	156.00	10	\$4,164.45	Pcs
P2401S	HG	3/8"-16	165.00	10	\$4,888.75	Pcs
P2403S	GR	1/2"-13	201.00	10	\$4,680.20	Pcs
P2403S	EG	1/2"-13	201.00	10	\$4,680.20	Pcs
P2403S	HG	1/2"-13	213.00	10	\$5,662.15	Pcs

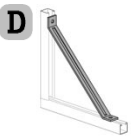
						
P2452	GR		277.00	25	\$2,063.30	Pcs
P2452	EG		277.00	25	\$2,063.30	Pcs
P2452	HG		293.60	25	\$2,292.35	Pcs

						
P2453	GR		116.00	20	\$2,412.70	Pcs
P2453	EG		116.00	20	\$2,412.70	Pcs
P2453	HG		123.00	20	\$2,529.00	Pcs
P2453	SS		116.00	20	CALL	Pcs

						
P2454	GR		148.00	10	\$2,071.50	Pcs
P2454	EG		148.00	10	\$2,071.50	Pcs

						
P2458-18	GR	18"	220.00	25	\$2,733.20	Pcs
P2458-24	GR	24"	280.00	25	\$2,986.50	Pcs
P2458-30	GR	30"	340.00	25	\$3,592.40	Pcs
P2458-36	GR	36"	400.00	25	\$3,829.15	Pcs

Part No.	Fin.	Size	W/100	Std Qty	\$/100	UM
						
P2459-36	GR	36"	375.00	25	\$3,473.80	Pcs
P2459-42	GR	42"	435.00	25	\$3,704.45	Pcs
P2459-48	GR	48"	495.00	25	\$4,308.75	Pcs
P2459-54	GR	54"	555.00	25	\$4,539.40	Pcs
P2459-60	GR	60"	615.00	25	\$4,768.05	Pcs
P2459-72	GR	72"	735.00	25	\$5,611.80	Pcs
P2459-84	GR	84"	855.00	25	\$6,062.95	Pcs
P2459-96	GR	96"	975.00	25	\$6,214.50	Pcs

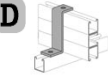
						
P2469	GR		93.00	25	\$1,146.20	Pcs
P2469	EG		93.00	25	\$1,146.20	Pcs
P2469	HG		99.00	25	\$1,260.80	Pcs

						
P2470-100	EG	For 1" Pipe	103.00	10	\$3,865.10	Pcs
P2470-50	EG	For 1/2" Pipe	77.00	10	\$2,882.20	Pcs
P2470-75	EG	For 3/4" Pipe	93.00	10	\$3,291.85	Pcs

						
P2472L	GR	L	75.00	10	\$1,658.95	Pcs
P2472L	EG	L	75.00	10	\$1,658.95	Pcs
P2472R	GR	R	75.00	10	\$1,658.95	Pcs
P2472R	EG	R	75.00	10	\$1,658.95	Pcs

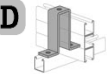
						
P2473	GR		197.00	10	\$2,005.30	Pcs
P2473	EG		197.00	10	\$2,005.30	Pcs
P2473	HG		208.80	10	\$2,214.95	Pcs

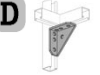
						
P2484	GR		134.00	20	\$1,098.30	Pcs
P2484	EG		134.00	20	\$1,098.30	Pcs
P2484	HG		141.00	20	\$1,384.75	Pcs

						
P2484W	GR		134.00	20	\$1,880.80	Pcs
P2484W	EG		134.00	20	\$1,880.80	Pcs
P2484W	HG		141.00	20	\$2,090.45	Pcs

AL-Alum.; CP-Cadmium Plated; EA- Extruded Alum.; EG-Electro-Galv.; EV-Everdur; FG-Fiberglass Reinforced Polyester; GR-Perma-Green; GY-Gray; HG-Hot Dip Galv.; MA-Maple; WH-White; NC-No Closure Strip; W/End Caps and Back Plates; PL-Plain; PG-Pre-Galv.; PO-Porcelain; SS-Stainless 304; ST-Stainless 316; WC-W/Closure Strip, End Caps and Back Plates; X-No Closure Strip or End Caps, W/Back Plates; ZD-Yellow Zinc Dichromate
 Note: For part details and loading information refer to the current Unistrut General Engineering Catalog.

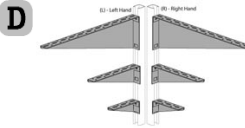
Part No.	Fin.	Size	Wt/100	Std Qty	\$/100	UM
						
P2491L	GR	6" Left	67.00	25	\$1,402.50	Pcs
P2491L	EG	6" Left	67.00	25	\$1,402.50	Pcs
P2491R	GR	6" Right	67.00	25	\$1,402.50	Pcs
P2491R	EG	6"	61.00	25	\$1,402.50	Pcs
P2492L	GR	8" Left	92.00	25	\$1,435.80	Pcs
P2492L	EG	8" Left	97.50	25	\$1,435.80	Pcs
P2492R	GR	8" Right	92.00	25	\$1,435.80	Pcs
P2492R	EG	8" Right	86.00	25	\$1,435.80	Pcs
P2493L	GR	10" Left	120.00	25	\$1,734.45	Pcs
P2493L	EG	10" Left	120.00	50	\$1,734.45	Pcs
P2493L	HG	10" Left	127.00	25	\$1,911.05	Pcs
P2493R	GR	10" Right	120.00	25	\$1,734.45	Pcs
P2493R	EG	10" Right	120.00	50	\$1,734.45	Pcs
P2493R	HG	10" Right	127.00	25	\$1,911.05	Pcs

Part No.	Fin.	Size	Wt/100	Std Qty	\$/100	UM
						
P2494L	GR	12" Left	152.00	25	\$2,111.20	Pcs
P2494L	EG	12" Left	152.00	25	\$2,111.20	Pcs
P2494L	HG	12" Left	161.10	25	\$2,187.10	Pcs
P2494R	GR	12" Right	152.00	25	\$2,111.20	Pcs
P2494R	EG	12" Right	152.00	50	\$2,111.20	Pcs
P2494R	HG	12" Right	161.10	25	\$2,187.10	Pcs
P2495L	GR	14" Left	173.00	25	\$2,688.05	Pcs
P2495L	HG	14" Left	183.40	25	\$2,785.05	Pcs
P2495R	GR	14" Right	173.00	25	\$2,688.05	Pcs
P2495R	HG	14" Right	183.40	25	\$2,785.05	Pcs
P2496L	GR	16" Left	223.00	20	\$3,057.40	Pcs
P2496L	HG	16" x L	237.00	20	\$3,233.30	Pcs
P2496R	EG	16"	210.00	20	\$3,057.40	Pcs
P2496R	GR	16" x R	223.00	20	\$3,057.40	Pcs
P2496R	HG	16" x R	236.40	20	\$3,233.30	Pcs
P2496R	PL	16" x R	223.00	20	\$2,845.70	Pcs
P2497L	GR	18" x L	266.00	20	\$3,600.25	Pcs
P2497L	HG	18" x L	265.00	20	\$3,619.90	Pcs
P2497R	GR	18" x R	266.00	20	\$3,600.25	Pcs
P2497R	HG	18" x R	265.00	20	\$3,808.25	Pcs
P2498L	GR	20" x L	308.00	20	\$3,816.10	Pcs
P2498R	GR	20" x R	308.00	20	\$3,816.10	Pcs
P2498R	HG	20" x R	326.00	20	\$3,808.25	Pcs
P2499L	GR	22" x L	355.00	20	\$4,065.00	Pcs
P2499L	HG	22" x L	366.00	20	\$4,226.50	Pcs
P2499R	GR	22" x R	355.00	20	\$4,065.00	Pcs
P2499R	HG	22" x R	366.00	20	\$4,226.50	Pcs

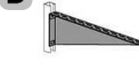









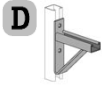

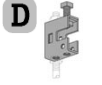

Part No.	Fin.	Size	Wt/100	Std Qty	\$/100	UM
						
P2500L	GR	24" x L	400.00	10	\$4,760.80	Pcs
P2500L	HG	24" x L	424.00	10	\$5,386.25	Pcs
P2500R	GR	24" x R	400.00	10	\$4,760.80	Pcs
P2500R	HG	24" x R	424.00	10	\$5,386.25	Pcs
P2501L	GR	26" x L	445.00	10	\$5,109.95	Pcs
P2501L	HG	26" x L	472.00	10	\$5,263.45	Pcs
P2501R	GR	26" x R	445.00	10	\$5,109.95	Pcs
P2501R	HG	26" x R	472.00	10	\$5,263.45	Pcs
P2502L	GR	28" x L	493.00	10	\$5,366.95	Pcs
P2502R	GR	28" x R	493.00	10	\$5,366.95	Pcs
P2503L	GR	30" x L	545.00	10	\$5,650.50	Pcs
P2503L	HG	30" x L	578.00	10	\$6,861.60	Pcs
P2503R	GR	30" x R	545.00	10	\$5,650.50	Pcs
P2503R	HG	30" x R	578.00	10	\$6,861.60	Pcs

Part No.	Fin.	Size	Wt/100	Std Qty	\$/100	UM
						
P2513	GR	6"	161.00	20	\$4,144.85	Pcs
P2513	PG	6"	161.00	20	\$4,144.85	Pcs
P2513	HG	6"	170.70	20	\$4,481.30	Pcs
P2513	SS	6"	161.00	20	CALL	Pcs
P2514	GR	12"	261.00	20	\$4,368.65	Pcs
P2514	PG	12"	261.00	20	\$4,368.65	Pcs
P2514	HG	12"	276.70	20	\$4,601.75	Pcs
P2514	SS	12"	261.00	20	CALL	Pcs
P2515	GR	18"	361.00	10	\$5,084.10	Pcs
P2515	PG	18"	361.00	10	\$5,084.10	Pcs
P2515	HG	18"	382.70	10	\$5,279.75	Pcs
P2515	SS	18"	361.00	10	CALL	Pcs
P2516	GR	24"	461.00	15	\$5,733.30	Pcs
P2516	PG	24"	461.00	15	\$5,733.30	Pcs
P2516	HG	24"	488.70	15	\$6,159.75	Pcs
P2516	SS	24"	461.00	10	CALL	Pcs





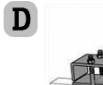
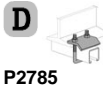
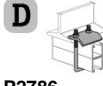
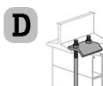









Part No.	Fin.	Size	Wt/100	Std Qty	\$/100	UM
						
P2513A	GR	6"	161.00	20	\$4,144.85	Pcs
P2513A	PG	6"	161.00	20	\$4,144.85	Pcs
P2513A	HG	6"	170.70	20	\$4,481.30	Pcs
P2514A	GR	12"	261.00	20	\$4,368.65	Pcs
P2514A	PG	12"	261.00	20	\$4,368.65	Pcs
P2514A	HG	12"	276.70	20	\$4,601.75	Pcs
P2515A	GR	18"	361.00	10	\$5,084.10	Pcs
P2515A	PG	18"	361.00	10	\$5,084.10	Pcs
P2515A	HG	18"	382.70	10	\$5,279.75	Pcs
P2515A	SS	18"	361.00	10	CALL	Pcs
P2516A	GR	24"	461.00	15	\$5,733.30	Pcs
P2516A	PG	24"	461.00	15	\$5,733.30	Pcs
P2516A	HG	24"	488.70	15	\$6,159.75	Pcs





















Part No.	Fin.	Size	Wt/100	Std Qty	\$/100	UM
						
P2542	GR	12"	502.00	10	\$8,186.30	Pcs
P2542	PG	12"	502.00	10	\$8,186.30	Pcs
P2542	HG	12"	532.10	10	\$8,663.10	Pcs
P2542	SS	12"	502.00	10	CALL	Pcs
P2543	GR	18"	692.00	10	\$9,184.00	Pcs
P2543	PG	18"	692.00	10	\$9,184.00	Pcs
P2543	HG	18"	733.50	10	\$9,873.85	Pcs
P2543	SS	18"	692.00	10	CALL	Pcs
P2544	GR	24"	882.00	10	\$11,025.85	Pcs
P2544	PG	24"	882.00	10	\$11,025.85	Pcs
P2544	HG	24"	934.90	10	\$11,442.35	Pcs
P2544	SS	24"	882.00	10	CALL	Pcs
P2545	GR	30"	1072.00	10	\$11,845.70	Pcs
P2545	PG	30"	1072.00	10	\$11,845.70	Pcs
P2545	HG	30"	1136.30	10	\$13,209.15	Pcs
P2545	SS	30"	1072.00	10	CALL	Pcs
P2546	GR	36"	1262.00	10	\$12,447.80	Pcs
P2546	PG	36"	1262.00	10	\$12,447.80	Pcs
P2546	HG	36"	1337.70	10	\$13,817.05	Pcs
P2546	SS	36"	1262.00	10	CALL	Pcs

AL-Alum.; CP-Cadmium Plated; EA- Extruded Alum.; EG-Electro-Galv.; EV-Everdur; FG-Fiberglass Reinforced Polyester; GR-Perma-Green; GY-Gray; HG-Hot Dip Galv.; MA-Maple; WH-White; NC-No Closure Strip; W/End Caps and Back Plates; PL-Plain; PG-Pre-Galv.; PO-Porcelain; SS-Stainless 304; ST-Stainless 316; WC-W/Closure Strip, End Caps and Back Plates; X-No Closure Strip or End Caps, W/Back Plates; ZD-Yellow Zinc Dichromate
 Note: For part details and loading information refer to the current Unistrut General Engineering Catalog.

Part No.	Fin.	Size	Wt/100	Std Qty	\$/100 UM	Part No.	Fin.	Size	Wt/100	Std Qty	\$/100 UM
											
P2547	GR	15"	420.00	10	\$8,472.05 Pcs						
P2547	HG	15"	445.00	10	\$9,580.50 Pcs						
P2548	HG	21"	666.00	10	\$13,700.95 Pcs						
P2549	GR	27"	860.00	10	\$16,315.05 Pcs						
P2549	HG	27"	912.00	10	\$18,757.45 Pcs						
P2550	GR	33"	1010.00	10	\$17,042.15 Pcs						
P2550	HG	33"	1071.00	10	\$19,933.80 Pcs						
P2551	GR	39"	1257.00	10	\$17,191.70 Pcs						
P2551	HG	39"	1332.00	10	\$20,807.55 Pcs						
											
P2626	GR		40.00	50	\$503.60 Pcs						
P2626	EG		40.00	50	\$503.60 Pcs						
P2626	HG		42.40	50	\$490.75 Pcs						
											
P2655	GR		213.00	25	\$2,873.75 Pcs						
P2655	HG		225.80	25	\$3,319.10 Pcs						
											
P2674	GR		17.00	50	\$995.60 Pcs						
P2674	EG		17.00	50	\$995.60 Pcs						
											
P2675	GR		33.00	25	\$768.40 Pcs						
P2675	EG		33.00	25	\$768.40 Pcs						
P2675	HG		35.00	25	\$742.55 Pcs						
											
P2676	GR		72.00	25	\$1,371.10 Pcs						
P2676	EG		72.00	25	\$1,371.10 Pcs						
P2676	HG		76.30	25	\$1,485.45 Pcs						
											
P2677	GR		30.00	25	\$1,063.50 Pcs						
P2677	EG		30.00	25	\$1,063.50 Pcs						
P2677	HG		30.00	25	\$1,047.60 Pcs						
											
P2679-4	EG	1/4"-20	4.00	200	\$1,000.00 Pcs						
P2679-6	EG	3/8"-16	5.00	100	\$1,003.70 Pcs						
P2679-8	EG	1/2"-13	6.00	100	\$1,005.90 Pcs						
											
P2682	GR		55.00	25	\$1,316.00 Pcs						
P2682	EG		55.00	25	\$1,316.00 Pcs						
P2682	HG		59.00	25	\$1,342.00 Pcs						
											
P2749	EG		21.00	25	\$2,701.55 Pcs						
P2749	SS		21.00	25	CALL Pcs						
P2749N	EG		13.00	25	\$1,780.65 Pcs						
											
P2750	EG		55.00	25	\$4,854.10 Pcs						
P2750	SS		55.00	25	CALL Pcs						
P2750N	EG		32.00	25	\$3,408.50 Pcs						
P2750N	SS		32.00	25	CALL Pcs						
											
P2751	EG		63.00	25	\$5,320.05 Pcs						
P2751N	EG		40.00	25	\$4,036.15 Pcs						
											
P2784-1	HG	1-5/8" Channel	175.00	25	CALL Pcs						
P2784-2	HG	3-1/4" Channel	179.00	25	CALL Pcs						
P2784-3	HG	6-1/2" Channel	180.00	25	CALL Pcs						
											
P2785	EG		83.00	25	\$763.70 Pcs						
P2785	HG		88.00	25	\$909.70 Pcs						
P2785	ZD		83.00	25	\$763.70 Pcs						
P2785	SS		83.00	25	CALL Pcs						
											
P2786	EG		92.00	25	\$894.20 Pcs						
P2786	HG		97.50	25	\$991.20 Pcs						
P2786	ZD		92.00	25	\$894.20 Pcs						
P2786	SS		92.00	25	CALL Pcs						
											
P2787	EG		112.00	25	\$1,128.55 Pcs						
P2787	HG		117.00	25	\$1,168.75 Pcs						
P2787	ZD		98.00	25	\$1,128.55 Pcs						
											
P2800-25	EG	1/4"	14.00	100	\$385.55 Pcs						
P2800-37	EG	3/8"	14.00	100	\$395.60 Pcs						
P2800-37	EG	3/8"	14.00	100	\$395.60 Pcs						
P2800-50	EG	1/2"	14.00	100	\$404.50 Pcs						
P2800-62	EG	5/8"	14.00	100	\$419.15 Pcs						

AL-Alum.; CP-Cadmium Plated; EA- Extruded Alum.; EG-Electro-Galv.; EV-Everdur; FG-Fiberglass Reinforced Polyester; GR-Perma-Green; GY-Gray; HG-Hot Dip Galv.; MA-Maple; WH-White; NC-No Closure Strip; W/End Caps and Back Plates; PL-Plain; PG-Pre-Galv.; PO-Porcelain; SS-Stainless 304; ST-Stainless 316; WC-W/Closure Strip, End Caps and Back Plates; X-No Closure Strip or End Caps, W/Back Plates; ZD-Yellow Zinc Dichromate
 Note: For part details and loading information refer to the current Unistrut General Engineering Catalog.

Part No.	Fin.	Size	Wt/100	Std Qty	\$/100	UM
						
						
P2815	GR		307.00	10	\$4,796.15	Pcs
P2815	EG		307.00	10	\$4,796.15	Pcs
P2815	HG		325.00	10	\$5,327.45	Pcs
						
						
P2815D	GR		497.00	5	\$6,636.15	Pcs
P2815D	EG		497.00	5	\$6,636.15	Pcs
						
						
P2824-12	EG	8-1/2" - 12"	171.00	25	\$1,412.90	Pcs
P2824-6	EG	2-1/2" - 6"	140.00	25	\$1,219.70	Pcs
P2824-9	EG	5-1/2" - 9"	125.00	25	\$1,311.15	Pcs
						
						
P2859-10	GR	10	12.00	0	\$332.40	Pcs
P2859-10	BK	10	2.20	100	\$332.40	Pcs
P2859-10	GY	10	12.00	0	\$332.40	Pcs
P2859-10	WH	10	12.00	0	\$332.40	Pcs
P2859-10	YW	10	3.10	100	\$332.40	Pcs
P2859-11	GR	11	12.00	0	\$503.25	Pcs
P2859-11	GY	11	12.00	0	\$503.25	Pcs
P2859-11	WH	11	12.00	0	\$503.25	Pcs
P2859-12	GR	12	5.00	0	\$271.30	Pcs
P2859-12	GY	12	5.00	0	\$271.30	Pcs
P2859-12	WH	12	5.00	0	\$271.30	Pcs
P2859-13	GR	13	22.00	0	\$438.55	Pcs
P2859-13	GY	13	22.00	0	\$438.55	Pcs
P2859-13	WH	13	22.00	0	\$438.55	Pcs
P2859-14	GR	14	17.00	0	\$393.15	Pcs
P2859-14	GY	14	17.00	0	\$393.15	Pcs
P2859-14	WH	14	17.00	0	\$393.15	Pcs
						
						
P2860-10	VY	10	3.40	50	\$286.30	Pcs
P2860-33	VY	33	2.50	50	\$265.55	Pcs
P2860-50	VY	50	5.00	50	\$487.30	Pcs
P2860-55	VY	55	4.70	50	\$671.65	Pcs
						
						
P2862	EG	5/16"	18.00	100	\$197.60	Pcs
P2862	HG	5/16"	19.10	100	\$213.35	Pcs
P2863	GR	3/8"	18.00	100	\$315.10	Pcs
P2863	EG	3/8"	18.00	100	\$211.15	Pcs
P2863	HG	3/8"	19.10	100	\$216.35	Pcs
P2863	ZD	3/8"	18.00	100	\$211.15	Pcs
P2864	EG	1/2"	17.00	100	\$220.60	Pcs
P2864	HG	1/2"	18.00	100	\$225.25	Pcs
P2864	ZD	1/2"	17.00	100	\$220.60	Pcs
						
						
P2867	EG	6"	134.00	25	\$1,666.45	Pcs

Part No.	Fin.	Size	Wt/100	Std Qty	\$/100	UM
						
						
P2867A	EG	6"	143.00	10	\$1,826.40	Pcs
P2867A-12	EG	12"	152.00	10	\$1,925.50	Pcs
P2867A-9	EG	9"	148.00	10	\$1,883.45	Pcs
						
						
P2868	EG		280.00	10	\$2,636.40	Pcs
						
						
P2868A	EG		298.00	10	\$2,949.65	Pcs
						
						
P2893	EG		14.00	50	\$383.10	Pcs
						
						
P2894-25	EG	1/4"	23.00	50	\$425.75	Pcs
P2894-37	EG	3/8"	95.00	25	\$1,799.95	Pcs
P2894-50	EG	1/2"	195.00	25	\$2,568.25	Pcs
						
						
P2895-37	EG	3/8"	35.00	50	\$729.05	Pcs
P2895-62	EG	5/8"	67.00	50	\$2,746.80	Pcs
P2895-75	EG	3/4"	78.00	50	\$3,175.65	Pcs
						
						
P2896-37	EG	3/8"	38.00	50	\$1,409.70	Pcs
P2896-50	EG	1/2"	52.00	50	\$1,433.70	Pcs
P2896-62	EG	5/8"	68.00	50	\$1,883.45	Pcs
P2896-75	EG	3/4"	128.00	10	\$2,808.95	Pcs
						
						
P2897	EG		60.00	10	\$2,782.50	Pcs
						
						
P2898-37	EG	3/8"	33.00	50	\$772.80	Pcs
P2898-50	EG	1/2"	33.00	50	\$1,242.20	Pcs
P2898-50	PL	1/2"	33.00	50	\$1,118.50	Pcs
P2898-87	EG	7/8"	79.00	25	\$2,498.50	Pcs
						
						
P2899-37	EG	3/8"	28.00	50	\$831.00	Pcs
P2899-37	PL	3/8"	28.00	50	\$617.70	Pcs
P2899-50	EG	1/2"	34.00	50	\$1,376.65	Pcs
P2899-50	PL	1/2"	34.00	50	\$1,036.50	Pcs
P2899-62	EG	5/8"	66.00	25	\$2,026.55	Pcs
P2899-62	PL	5/8"	66.00	25	\$1,905.85	Pcs
P2899-75	EG	3/4"	83.00	25	\$2,542.25	Pcs

AL-Alum.; CP-Cadmium Plated; EA- Extruded Alum.; EG-Electro-Galv.; EV-Everdur; FG-Fiberglass Reinforced Polyester; GR-Perma-Green; GY-Gray; HG-Hot Dip Galv.; MA-Maple; WH-White; NC-No Closure Strip; W/End Caps and Back Plates; PL-Plain; PG-Pre-Galv.; PO-Porcelain; SS-Stainless 304; ST-Stainless 316; WC-W/Closure Strip, End Caps and Back Plates; X-No Closure Strip or End Caps, W/Back Plates; ZD-Yellow Zinc Dichromate
 Note: For part details and loading information refer to the current Unistrut General Engineering Catalog.

Part No. Fin. Size Wt/100 Std Qty \$/100 UM

D					
P2941	GR		278.00	10	\$4,057.40 Pcs
P2941	EG		278.00	10	\$4,057.40 Pcs
P2941	HG		295.00	10	\$4,579.00 Pcs
P2941	SS		278.00	10	CALL Pcs

D					
P2942	GR		278.00	10	\$4,222.10 Pcs
P2942	EG		278.00	10	\$4,222.10 Pcs
P2942	HG		295.00	10	\$4,579.00 Pcs
P2942	SS		278.00	10	CALL Pcs

D					
P2944	GR	6"	132.00	10	\$3,976.45 Pcs
P2945	PG	12"	293.00	10	\$4,558.80 Pcs
P2945	HG	12"	311.00	10	\$5,007.05 Pcs
P2945	SS	12"	0.00	10	CALL Pcs
P2946	GR	18"	401.00	10	\$3,953.70 Pcs
P2947	PG	24"	509.00	10	\$6,543.65 Pcs

D					
P2949	EG		46.00	25	\$4,254.55 Pcs
P2949	SS		46.00	25	CALL Pcs

D					
P2950	EG		110.00	10	\$6,680.40 Pcs

D					
P2950XL	EG		419.10	10	\$7,703.25 Pcs

D					
P3045	GR		53.00	25	\$700.30 Pcs
P3045	EG		53.00	25	\$700.30 Pcs
P3045	HG		56.20	25	\$751.20 Pcs

D					
P3047	GR		84.00	25	\$1,098.15 Pcs
P3047	EG		84.00	25	\$1,098.15 Pcs
P3047	HG		89.00	25	\$1,240.25 Pcs

D					
P3087	EG		136.00	25	\$2,507.75 Pcs
P3088	EG		120.00	25	\$2,460.50 Pcs

Part No. Fin. Size Wt/100 Std Qty \$/100 UM

D					
P3345	GR		47.00	50	\$672.65 Pcs
P3345	EG		47.00	50	\$672.65 Pcs
P3345	SS		47.00	50	CALL Pcs

D					
P4043	GR		106.00	20	\$1,639.30 Pcs
P4043	EG		106.00	20	\$1,639.30 Pcs
P4043	HG		112.40	20	\$1,683.40 Pcs

D					
P4045	GR		47.00	50	\$552.45 Pcs
P4045	EG		47.00	50	\$552.45 Pcs
P4045	HG		49.80	50	\$619.75 Pcs

D					
P4047	GR		71.00	25	\$781.60 Pcs
P4047	EG		71.00	25	\$781.60 Pcs
P4047	HG		75.30	25	\$900.00 Pcs
P4047	ZD		71.00	25	\$781.60 Pcs
P4047	SS		71.00	25	CALL Pcs

D					
P4376	GR		85.00	20	\$856.45 Pcs
P4376	EG		85.00	20	\$856.45 Pcs
P4376	HG		90.00	20	\$904.85 Pcs

D					
P4376A	GR		130.00	10	\$1,208.95 Pcs
P4376A	EG		130.00	10	\$1,208.95 Pcs

D					
P5543	GR		97.00	10	\$1,568.70 Pcs
P5543	EG		97.00	10	\$1,568.70 Pcs

D					
P5545	GR		67.00	20	\$1,032.45 Pcs
P5545	EG		67.00	20	\$1,032.45 Pcs
P5545	HG		71.00	20	\$1,142.05 Pcs

D					
P5547	GR		108.00	20	\$1,456.70 Pcs
P5547	EG		108.00	20	\$1,456.70 Pcs
P5547	HG		114.50	20	\$1,599.70 Pcs

D					
P5560	EG		11.00	100	\$608.20 Pcs

AL-Alum.; CP-Cadmium Plated; EA- Extruded Alum.; EG-Electro-Galv.; EV-Everdur; FG-Fiberglass Reinforced Polyester; GR-Perma-Green; GY-Gray; HG-Hot Dip Galv.; MA-Maple; WH-White; NC-No Closure Strip; W/End Caps and Back Plates; PL-Plain; PG-Pre-Galv.; PO-Porcelain; SS-Stainless 304; ST-Stainless 316; WC-W/Closure Strip, End Caps and Back Plates; X-No Closure Strip or End Caps, W/Back Plates; ZD-Yellow Zinc Dichromate
 Note: For part details and loading information refer to the current Unistrut General Engineering Catalog.

Part No.	Fin.	Size	Wt/100	Std Qty	\$/100	UM	Part No.	Fin.	Size	Wt/100	Std Qty	\$/100	UM
----------	------	------	--------	---------	--------	----	----------	------	------	--------	---------	--------	----

D

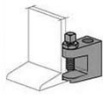

PFL037		3/8"	28.00	0	CALL	Pcs
PFL037T		3/8" Tapped	28.00	0	CALL	Pcs
PFL050		1/2"	40.00	0	CALL	Pcs
PFL050T		1/2" Tapped	40.00	0	CALL	Pcs

D



PFL2-37	ZD		26.00	50	\$416.85	Pcs
PFL2-37	SS		26.00	50	\$1,114.00	Pcs

D

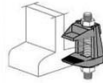

PLF3037		3/8"	53.00	0	CALL	Pcs
PLF3050		1/2"	91.00	0	CALL	Pcs
PLF3062		5/8"	186.00	0	CALL	Pcs
PLF3075		3/4"	334.00	0	CALL	Pcs

D



PLF9037		3/8"	55.00	0	CALL	Pcs
PLF9050		1/2"	122.00	0	CALL	Pcs
PLF9062		5/8"	200.00	0	CALL	Pcs
PLF9075		3/4"	367.00	0	CALL	Pcs
PLF9100		1"	1101.00	0	CALL	Pcs

D



PLLC025		1/4"	16.00	0	CALL	Pcs
----------------	--	------	-------	---	-------------	-----

D



AEROSPRAY	GR		100.00	1	\$3,523.10	Pcs
------------------	-----------	--	--------	---	-------------------	-----

AL-Alum.; CP-Cadmium Plated; EA- Extruded Alum.; EG-Electro-Galv.; EV-Everdur; FG-Fiberglass Reinforced Polyester; GR-Perma-Green; GY-Gray; HG-Hot Dip Galv.; MA-Maple; WH-White; NC-No Closure Strip; W/End Caps and Back Plates; PL-Plain; PG-Pre-Galv.; PO-Porcelain; SS-Stainless 304; ST-Stainless 316; WC-W/Closure Strip, End Caps and Back Plates; X-No Closure Strip or End Caps, W/Back Plates; ZD-Yellow Zinc Dichromate
 Note: For part details and loading information refer to the current Unistrut General Engineering Catalog.

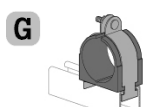
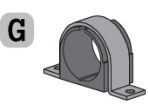
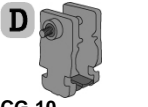
Part No.	Fin.	Size	Wt/100	Std Qty	\$/100	UM	Part No.	Fin.	Size	Wt/100	Std Qty	\$/100	UM
							(Continued from previous column)						
004T008	EG	1/4"	10.00	25	\$515.25	Pcs	046N052	EG	2-7/8"	55.00	10	\$3,248.30	Pcs
004T008	ZD	1/4"	10.00	25	\$515.25	Pcs	046N052	ZD	2-7/8"	55.00	10	\$3,248.30	Pcs
004T008	SS	1/4"	10.00	25	CALL	Pcs	046N052	SS	2-7/8"	55.00	10	CALL	Pcs
006T010	EG	3/8"	11.00	25	\$515.25	Pcs	050N054	EG	3"	60.00	10	\$3,548.05	Pcs
006T010	ZD	3/8"	11.00	25	\$515.25	Pcs	050N054	ZD	3"	60.00	10	\$3,548.05	Pcs
006T010	SS	3/8"	11.00	25	CALL	Pcs	050N056	EG	3-1/8"	60.00	10	\$3,677.85	Pcs
008T012	EG	1/2"	13.00	25	\$515.25	Pcs	050N056	ZD	3-1/8"	60.00	10	\$3,677.85	Pcs
008T012	ZD	1/2"	13.00	25	\$515.25	Pcs	056N062	EG	3-1/2"	64.00	10	\$4,749.50	Pcs
008T012	SS	1/2"	13.00	25	CALL	Pcs	056N062	ZD	3-1/2"	64.00	10	\$4,749.50	Pcs
009N012	EG	1/4"	13.00	25	\$515.25	Pcs	056N062	SS	3-1/2"	64.00	10	CALL	Pcs
009N012	ZD	1/4"	13.00	25	\$515.25	Pcs	058N064	EG	3-5/8"	70.00	10	\$5,320.75	Pcs
009N012	SS	1/4"	13.00	25	CALL	Pcs	058N064	ZD	3-5/8"	70.00	10	\$5,320.75	Pcs
010N014	EG	1/4"	14.00	25	\$540.20	Pcs	064N072	EG	4"	88.00	10	\$6,734.55	Pcs
010N014	ZD	1/4"	14.00	25	\$540.20	Pcs	064N072	ZD	4"	88.00	10	\$6,734.55	Pcs
010N014	SS	1/4"	14.00	25	CALL	Pcs	064N072	SS	4"	88.00	10	CALL	Pcs
010T014	EG	5/8"	14.00	25	\$540.20	Pcs	066N074	EG	4-1/8"	94.00	5	\$6,957.60	Pcs
010T014	ZD	5/8"	14.00	25	\$540.20	Pcs	066N074	ZD	4-1/8"	94.00	5	\$6,957.60	Pcs
010T014	SS	5/8"	14.00	25	CALL	Pcs	066N074	SS	4-1/8"	94.00	5	\$6,957.60	Pcs
011N014	EG	3/8"	14.00	25	\$540.20	Pcs	069N076	EG	4-5/16"	100.00	5	\$7,799.85	Pcs
012T016	EG	3/4"	14.00	25	\$588.00	Pcs	072N080	EG	4-1/2"	110.00	5	\$7,752.00	Pcs
012T016	ZD	3/4"	14.00	25	\$588.00	Pcs	072N080	ZD	4-1/2"	110.00	5	\$7,752.00	Pcs
012T016	SS	3/4"	14.00	25	CALL	Pcs	072N080	SS	4-1/2"	110.00	5	CALL	Pcs
014N018	EG	7/8"	15.00	25	\$666.90	Pcs	072N080	SS	4-1/2"	110.00	5	CALL	Pcs
014T018	EG	7/8"	15.00	25	\$666.90	Pcs	082N090	EG	5-1/8"	125.00	5	\$10,856.65	Pcs
014T018	ZD	7/8"	15.00	25	\$666.90	Pcs	089N096	EG	5"	130.00	5	\$11,509.00	Pcs
014T018	SS	7/8"	15.00	25	CALL	Pcs	089N096	SS	5"	130.00	5	CALL	Pcs
016T020	EG	1"	17.00	25	\$706.75	Pcs	098N106	EG	6-1/8"	130.00	5	\$14,613.75	Pcs
016T020	ZD	1"	17.00	25	\$706.75	Pcs	098N106	ZD	6-1/8"	130.00	5	\$14,613.75	Pcs
016T020	SS	1"	17.00	25	CALL	Pcs	106N114	EG	6"	140.00	5	\$16,051.15	Pcs
017N022	EG	3/4"	17.00	25	\$706.75	Pcs							
017N022	ZD	3/4"	17.00	25	\$706.75	Pcs	004M007	ZD	1/4"	3.40	25	\$365.00	Pcs
017N022	SS	3/4"	17.00	25	CALL	Pcs	006M008	ZD	3/8"	4.00	25	\$381.60	Pcs
018T022	EG	1-1/8"	18.00	20	\$794.40	Pcs	008M011	ZD	1/2"	5.50	25	\$381.60	Pcs
018T022	ZD	1-1/8"	18.00	20	\$794.40	Pcs	010M013	ZD	5/8"	6.00	25	\$381.60	Pcs
018T022	SS	1-1/8"	18.00	20	CALL	Pcs	012M015	ZD	3/4"	6.50	25	\$390.05	Pcs
020T024	EG	1-1/4"	18.00	20	\$930.00	Pcs	014M017	ZD	7/8"	7.10	25	\$406.45	Pcs
020T024	ZD	1-1/4"	18.00	20	\$930.00	Pcs	016M019	ZD	1"	7.80	25	\$421.25	Pcs
020T024	SS	1-1/4"	18.00	20	CALL	Pcs	018M020	ZD	3/4"	8.40	25	\$429.45	Pcs
021N026	EG	1"	19.00	20	\$938.00	Pcs	018M021	ZD	1-1/8"	8.40	25	\$446.20	Pcs
021N026	ZD	1"	19.00	20	\$938.00	Pcs	020M024	ZD	1-1/4"	4.20	10	\$556.70	Pcs
021N026	SS	1"	19.00	20	CALL	Pcs	021M026	ZD	1"	4.50	10	\$563.05	Pcs
022T026	EG	1-3/8"	20.00	20	\$938.00	Pcs	022M026	ZD	1-3/8"	4.40	10	\$571.25	Pcs
022T026	ZD	1-3/8"	20.00	20	\$938.00	Pcs	024M028	ZD	1-1/2"	4.50	10	\$579.35	Pcs
022T026	SS	1-3/8"	20.00	20	CALL	Pcs	027M032	ZD	1-1/4"	5.70	10	\$636.05	Pcs
024N028	EG	1-1/2"	33.00	20	\$959.25	Pcs	028M032	ZD	1-3/4"	5.70	10	\$666.90	Pcs
024N028	ZD	1-1/2"	33.00	20	\$959.25	Pcs	030M034	ZD	1-7/8"	5.90	10	\$692.20	Pcs
024N028	SS	1-1/2"	33.00	20	CALL	Pcs	032M036	ZD	2"	6.10	10	\$714.95	Pcs
026N030	EG	1-5/8"	35.00	20	\$1,127.85	Pcs	034M040	ZD	2-1/8"	6.60	10	\$771.40	Pcs
026N030	ZD	1-5/8"	35.00	20	\$1,127.85	Pcs							
026N030	SS	1-5/8"	35.00	20	CALL	Pcs	CG-10		1/4"	4.00	0	\$298.00	Pcs
026T030	EG	1-5/8"	35.00	20	\$1,127.85	Pcs	CG-20		3/8"	6.00	0	\$477.00	Pcs
027N032	EG	1-1/4"	35.00	20	\$1,351.25	Pcs	CG-30		1/2"	8.00	0	\$556.70	Pcs
027N032	ZD	1-1/4"	35.00	20	\$1,351.25	Pcs	CG-40		3/4"	8.00	0	\$596.00	Pcs
027N032	SS	1-1/4"	35.00	20	CALL	Pcs							
028N032	EG	1-3/4"	37.00	20	\$1,351.25	Pcs							
028N032	ZD	1-3/4"	37.00	20	\$1,351.25	Pcs							
028N032	SS	1-3/4"	37.00	20	CALL	Pcs							
030N034	EG	1-7/8"	39.00	20	\$1,453.10	Pcs							
030N034	ZD	1-7/8"	39.00	20	\$1,453.10	Pcs							
030N034	SS	1-7/8"	39.00	20	CALL	Pcs							
032N036	EG	2"	41.00	10	\$1,897.55	Pcs							
032N036	ZD	2"	41.00	10	\$1,897.55	Pcs							
032N036	SS	2"	41.00	10	CALL	Pcs							
034N040	EG	2-1/8"	46.00	10	\$2,151.75	Pcs							
034N040	ZD	2-1/8"	46.00	10	\$2,151.75	Pcs							
034N040	SS	2-1/8"	46.00	10	CALL	Pcs							
038N044	EG	2-3/8"	47.00	10	\$2,456.00	Pcs							
038N044	ZD	2-3/8"	47.00	10	\$2,456.00	Pcs							
038N044	SS	2-3/8"	47.00	10	CALL	Pcs							
040N046	EG	2-1/2"	49.00	10	\$2,533.50	Pcs							
040N046	ZD	2-1/2"	49.00	10	\$2,533.50	Pcs							
040N046	SS	2-1/2"	49.00	10	CALL	Pcs							
042N048	EG	2-5/8"	51.00	10	\$2,606.05	Pcs							
042N048	ZD	2-5/8"	51.00	10	\$2,606.05	Pcs							

AL-Alum.; CP-Cadmium Plated; EA- Extruded Alum.; EG-Electro-Galv.; EV-Everdur; FG-Fiberglass Reinforced Polyester; GR-Perma-Green; GY-Gray; HG-Hot Dip Galv.; MA-Maple; WH-White; NC-No Closure Strip; W/End Caps and Back Plates; PL-Plain; PG-Pre-Galv.; PO-Porcelain; SS-Stainless 304; ST-Stainless 316; WC-W/Closure Strip, End Caps and Back Plates; X-No Closure Strip or End Caps, W/Back Plates; ZD-Yellow Zinc Dichromate
 Note: For part details and loading information refer to the current Unistrut General Engineering Catalog.

Part No. Fin. Size Wt/100 Std Qty \$/100 UM Part No. Fin. Size Wt/100 Std Qty \$/100 UM

D



J1205	EG	1/2"	20.00	50	\$841.90	Pcs
J1205N	EG	1/2"	21.00	50	\$2,277.80	Pcs
J1207	EG	3/4"	21.00	50	\$856.45	Pcs
J1207N	EG	3/4"	22.00	50	\$2,486.25	Pcs
J1210	EG	1"	24.00	50	\$870.75	Pcs
J1210N	EG	1"	25.00	50	\$2,531.75	Pcs
J1212	EG	1-1/4"	27.00	50	\$886.00	Pcs
J1212N	EG	1-1/4"	29.00	50	\$2,876.20	Pcs
J1215	EG	1-1/2"	29.00	50	\$897.20	Pcs
J1215N	EG	1-1/2"	31.00	50	\$3,315.75	Pcs
J1220	EG	2"	33.00	50	\$956.35	Pcs
J1220N	EG	2"	35.00	50	\$3,946.30	Pcs
J1225	EG	1/1/04	71.00	50	\$1,811.40	Pcs
J1225N	EG	2-1/2"	74.00	50	\$5,261.85	Pcs
J1230	EG	3"	78.00	25	\$1,901.80	Pcs
J1230N	EG	3"	81.00	25	\$5,418.70	Pcs
J1235	EG	3-1/2"	85.00	25	\$2,037.20	Pcs
J1235N	EG	3-1/2"	88.00	25	\$5,727.90	Pcs
J1240	EG	4"	178.00	25	\$2,964.65	Pcs
J1240N	EG	4"	182.00	25	\$7,240.10	Pcs
J1250	EG	5"	199.00	20	\$3,268.75	Pcs
J1250N	EG	5"	203.00	20	\$7,217.35	Pcs
J1260	EG	6"	231.00	10	\$4,822.35	Pcs
J1260N	EG	6"	236.00	10	\$9,108.55	Pcs
J1280	EG	8"	449.00	10	\$6,557.50	Pcs
J1280N	EG	8"	458.00	10	\$10,680.50	Pcs

B

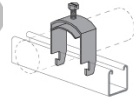

M5025	EG	3/8"	6.00	100	\$361.15	Pcs
M5025	AL	3/8"	3.50	100	CALL	Pcs
M5025	SS	3/8"	6.00	100	CALL	Pcs
M5026	EG	1/2"	7.00	100	\$362.00	Pcs
M5026	AL	1/2"	4.00	100	CALL	Pcs
M5026	SS	1/2"	7.00	100	CALL	Pcs
M5028	EG	3/4"	13.00	100	\$375.25	Pcs
M5028	AL	3/4"	7.00	100	CALL	Pcs
M5028	SS	3/4"	13.00	100	CALL	Pcs
M5030	EG	1"	15.00	100	\$385.55	Pcs
M5030	AL	1"	7.50	100	CALL	Pcs
M5030	SS	1"	16.00	100	CALL	Pcs
M5032	EG	1-1/4"	19.00	100	\$398.15	Pcs
M5032	AL	1-1/4"	8.50	100	CALL	Pcs
M5032	SS	1-1/4"	19.00	100	CALL	Pcs
M5034	EG	1-1/2"	20.00	100	\$502.45	Pcs
M5034	AL	1-1/2"	10.00	100	CALL	Pcs
M5034	SS	1-1/2"	20.00	100	CALL	Pcs
M5036	EG	1-3/4"	35.00	100	\$559.95	Pcs
M5036	AL	1-3/4"	16.00	100	CALL	Pcs
M5036	SS	1-3/4"	25.00	100	CALL	Pcs
M5038	EG	2"	35.00	100	\$667.95	Pcs
M5038	AL	2"	22.50	100	CALL	Pcs
M5038	SS	2"	35.00	100	CALL	Pcs
M5041	EG	2-3/8"	41.00	100	\$717.25	Pcs
M5041	AL	2-3/8"	28.00	100	CALL	Pcs
M5041	SS	2-3/8"	41.00	100	CALL	Pcs
M5044	EG	2-3/4"	60.00	75	\$762.65	Pcs
M5044	AL	2-3/4"	30.50	75	CALL	Pcs
M5044	SS	2-3/4"	60.00	75	CALL	Pcs
M5048	EG	3-1/4"	74.00	75	\$946.65	Pcs
M5048	AL	3-1/4"	37.00	75	CALL	Pcs
M5048	SS	3-1/4"	74.00	75	CALL	Pcs
M5052	EG	3-3/4"	91.00	50	\$1,179.25	Pcs
M5052	AL	3-3/4"	55.00	50	CALL	Pcs
M5054	EG	4"	100.00	40	\$1,119.55	Pcs
M5054	AL	4"	60.00	40	CALL	Pcs
M5057	EG	4-3/8"	115.00	30	\$1,207.65	Pcs
M5057	AL	4-3/8"	62.00	30	CALL	Pcs
M5057	SS	4-3/8"	115.00	30	CALL	Pcs
M5060	EG	4-3/4"	125.00	30	\$1,338.30	Pcs
M5060	AL	4-3/4"	65.00	30	CALL	Pcs
M5060	SS	4-3/4"	125.00	30	CALL	Pcs

AL-Alum.; CP-Cadmium Plated; EA- Extruded Alum.; EG-Electro-Galv.; EV-Everdur; FG-Fiberglass Reinforced Polyester; GR-Perma-Green; GY-Gray; HG-Hot Dip Galv.; MA-Maple; WH-White; NC-No Closure Strip; W/End Caps and Back Plates; PL-Plain; PG-Pre-Galv.; PO-Porcelain; SS-Stainless 304; ST-Stainless 316; WC-W/Closure Strip, End Caps and Back Plates; X-No Closure Strip or End Caps, W/Back Plates; ZD-Yellow Zinc Dichromate
 Note: For part details and loading information refer to the current Unistrut General Engineering Catalog.

Part No. Fin. Size Wt/100 Std Qty \$/100 UM Part No. Size Fin. Size Wt/100 Std Qty \$/100 UM

B

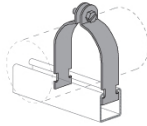

P1109	EG	3/8"	10.00	100	\$179.25	Pcs
P1109	HG	3/8"	10.60	100	\$205.60	Pcs
P1109	AL	3/8"	3.00	100	CALL	Pcs
P1109	SS	3/8"	10.00	100	CALL	Pcs
P1109	ST	3/8"	10.00	100	CALL	Pcs
P1111	EG	1/2"	11.00	100	\$181.90	Pcs
P1111	HG	1/2"	11.70	100	\$210.10	Pcs
P1111	CC	1/2"	12.00	100	\$384.25	Pcs
P1111	ZD	1/2"	11.00	100	\$181.90	Pcs
P1111	AL	1/2"	3.70	100	CALL	Pcs
P1111	SS	1/2"	11.00	100	CALL	Pcs
P1111	ST	1/2"	11.00	100	CALL	Pcs
P1111	PC	1/2"	1.10	100	\$2,523.90	Pcs
P1111AS	EG	1/2"	11.00	100	\$217.35	Pcs
P1111AS	ZD	1/2"	11.00	100	\$217.35	Pcs
P1111AS	AL	1/2"	4.00	100	CALL	Pcs
P1112	EG	3/4"	15.00	100	\$205.45	Pcs
P1112	HG	3/4"	15.90	100	\$245.55	Pcs
P1112	CC	3/4"	15.00	100	\$416.40	Pcs
P1112	ZD	3/4"	15.00	100	\$205.45	Pcs
P1112	AL	3/4"	5.00	100	CALL	Pcs
P1112	SS	3/4"	15.00	100	CALL	Pcs
P1112	ST	3/4"	15.00	100	CALL	Pcs
P1112	PC	3/4"	15.00	100	\$2,549.55	Pcs
P1112AS	EG	3/4"	15.00	100	\$247.15	Pcs
P1112AS	ZD	3/4"	15.00	100	\$247.15	Pcs
P1112AS	AL	3/4"	5.00	100	CALL	Pcs
P1113	EG	1"	17.00	100	\$219.20	Pcs
P1113	HG	1"	18.00	100	\$259.30	Pcs
P1113	CC	1"	17.00	100	\$575.20	Pcs
P1113	ZD	1"	17.00	100	\$219.20	Pcs
P1113	AL	1"	5.70	100	CALL	Pcs
P1113	SS	1"	17.00	100	CALL	Pcs
P1113	ST	1"	17.00	100	CALL	Pcs
P1113	PC	1"	17.00	100	\$2,555.45	Pcs
P1113AS	EG	1"	17.00	100	\$247.15	Pcs
P1113AS	HG	1"	17.00	100	\$282.50	Pcs
P1113AS	ZD	1"	17.00	100	\$247.15	Pcs
P1113AS	AL	1"	6.00	100	CALL	Pcs
P1113E	EG	1"	19.00	100	\$535.80	Pcs
P1114	EG	1-1/4"	19.00	100	\$253.65	Pcs
P1114	HG	1-1/4"	20.10	100	\$297.65	Pcs
P1114	CC	1-1/4"	20.00	100	\$594.60	Pcs
P1114	ZD	1-1/4"	19.00	100	\$253.65	Pcs
P1114	AL	1-1/4"	6.30	100	CALL	Pcs
P1114	SS	1-1/4"	19.00	100	CALL	Pcs
P1114	ST	1-1/4"	19.00	100	CALL	Pcs
P1114	PC	1-1/4"	19.00	100	\$2,571.60	Pcs
P1114AS	EG	1-1/4"	19.00	100	\$273.95	Pcs
P1114AS	ZD	1-1/4"	19.00	100	\$273.95	Pcs
P1114AS	AL	1-1/4"	7.00	100	CALL	Pcs
P1115	EG	1-1/2"	29.00	100	\$307.25	Pcs
P1115	HG	1-1/2"	30.70	50	\$384.05	Pcs
P1115	CC	1-1/2"	29.00	100	\$627.65	Pcs
P1115	ZD	1-1/2"	29.00	100	\$307.25	Pcs
P1115	AL	1-1/2"	9.70	50	CALL	Pcs
P1115	SS	1-1/2"	29.00	50	CALL	Pcs
P1115	ST	1-1/2"	29.00	100	CALL	Pcs
P1115AS	EG	1-1/2"	29.00	100	\$337.85	Pcs
P1115AS	HG	1-1/2"	29.00	100	\$398.15	Pcs
P1115AS	ZD	1-1/2"	29.00	100	\$337.85	Pcs
P1115AS	AL	1-1/2"	10.00	100	CALL	Pcs
P1115E	EG	1-1/2"	30.00	50	\$922.50	Pcs
P1117	EG	2"	34.00	50	\$331.50	Pcs
P1117	HG	2"	36.00	50	\$423.20	Pcs
P1117	CC	2"	34.00	50	\$674.50	Pcs
P1117	ZD	2"	34.00	50	\$331.50	Pcs
P1117	AL	2"	11.30	50	CALL	Pcs
P1117	SS	2"	34.00	50	CALL	Pcs
P1117	ST	2"	34.00	50	CALL	Pcs

(Continued from previous column)

P1117AS	EG	2"	34.00	50	\$379.40	Pcs
P1117AS	HG	2"	34.00	50	\$400.45	Pcs
P1117AS	ZD	2"	34.00	50	\$379.40	Pcs
P1117AS	AL	2"	12.00	50	CALL	Pcs
P1117E	EG	2"	35.00	50	\$921.55	Pcs
P1118	EG	2-1/2"	40.00	50	\$382.75	Pcs
P1118	HG	2-1/2"	42.40	50	\$464.10	Pcs
P1118	ZD	2-1/2"	40.00	50	\$382.75	Pcs
P1118	AL	2-1/2"	13.30	50	CALL	Pcs
P1118	SS	2-1/2"	40.00	50	CALL	Pcs
P1118	ST	2-1/2"	40.00	50	CALL	Pcs
P1118AS	EG	2-1/2"	41.00	50	\$400.45	Pcs
P1118AS	ZD	2-1/2"	40.00	50	\$400.45	Pcs
P1118AS	AL	2-1/2"	14.00	50	CALL	Pcs
P1119	EG	3"	47.00	50	\$422.40	Pcs
P1119	HG	3"	49.80	50	\$518.15	Pcs
P1119	ZD	3"	47.00	50	\$422.40	Pcs
P1119	AL	3"	15.70	50	CALL	Pcs
P1119	SS	3"	47.00	50	CALL	Pcs
P1119	ST	3"	47.00	50	CALL	Pcs
P1119AS	EG	3"	47.00	50	\$441.90	Pcs
P1119AS	ZD	3"	47.00	50	\$441.90	Pcs
P1119AS	AL	3"	16.00	50	CALL	Pcs
P1119E	EG	3"	48.00	50	\$1,020.10	Pcs
P1120	EG	3-1/2"	62.00	25	\$560.75	Pcs
P1120	HG	3-1/2"	65.70	25	\$670.00	Pcs
P1120	ZD	3-1/2"	62.00	25	\$560.75	Pcs
P1120	AL	3-1/2"	20.70	25	CALL	Pcs
P1120	SS	3-1/2"	62.00	25	CALL	Pcs
P1120	ST	3-1/2"	62.00	25	CALL	Pcs
P1120AS	EG	3-1/2"	62.00	25	\$591.15	Pcs
P1120AS	ZD	3-1/2"	62.00	25	\$591.15	Pcs
P1120AS	AL	3-1/2"	21.00	25	CALL	Pcs
P1120E	EG	3-1/2"	63.00	25	\$1,392.95	Pcs
P1121	EG	4"	67.00	25	\$588.35	Pcs
P1121	HG	4"	71.00	25	\$707.20	Pcs
P1121	ZD	4"	67.00	25	\$588.35	Pcs
P1121	AL	4"	22.30	25	CALL	Pcs
P1121	SS	4"	67.00	25	CALL	Pcs
P1121	ST	4"	67.00	25	CALL	Pcs
P1121AS	EG	4"	67.00	25	\$624.95	Pcs
P1121AS	ZD	4"	67.00	25	\$624.95	Pcs
P1121AS	AL	4"	0.00	25	CALL	Pcs
P1121E	EG	4"	68.00	25	\$1,421.10	Pcs
P1123	EG	5"	80.00	25	\$678.80	Pcs
P1123	HG	5"	84.80	25	\$809.20	Pcs
P1123	AL	5"	26.70	25	CALL	Pcs
P1123	SS	5"	80.00	25	CALL	Pcs
P1123AS	EG	5"	80.00	25	\$711.00	Pcs
P1123AS	ZD	5"	80.00	25	\$711.00	Pcs
P1123E	EG	5"	80.00	25	\$1,507.05	Pcs
P1124	EG	6"	102.00	25	\$1,052.10	Pcs
P1124	HG	6"	108.10	25	\$1,219.45	Pcs
P1124	AL	6"	35.00	25	CALL	Pcs
P1124	SS	6"	102.00	25	CALL	Pcs
P1124	PC	6"	102.00	25	\$6,337.25	Pcs
P1124AS	EG	6"	102.00	25	\$1,035.80	Pcs
P1124AS	ZD	6"	102.00	25	\$1,035.80	Pcs
P1124E	EG	6"	102.00	25	\$1,858.75	Pcs
P1126	EG	8"	130.00	25	\$1,239.55	Pcs
P1126	HG	8"	137.80	25	\$1,492.85	Pcs
P1126	AL	8"	40.00	25	CALL	Pcs
P1126	SS	8"	130.00	25	CALL	Pcs
P1126AS	EG	8"	130.00	25	\$1,224.75	Pcs

AL-Alum.; CP-Cadmium Plated; EA- Extruded Alum.; EG-Electro-Galv.; EV-Everdur; FG-Fiberglass Reinforced Polyester; GR-Perma-Green; GY-Gray; HG-Hot Dip Galv.; MA-Maple; WH-White; NC-No Closure Strip; W/End Caps and Back Plates; PL-Plain; PG-Pre-Galv.; PO-Porcelain; SS-Stainless 304; ST-Stainless 316; WC-W/Closure Strip, End Caps and Back Plates; X-No Closure Strip or End Caps, W/Back Plates; ZD-Yellow Zinc Dichromate
 Note: For part details and loading information refer to the current Unistrut General Engineering Catalog.

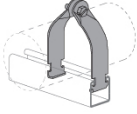
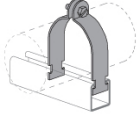
Part No.	Fin.	Size	Wt/100	Std Qty	\$/100	UM	Part No.	Fin.	Size	Wt/100	Std Qty	\$/100	UM
B 							B 						
P1211	EG	1/2"	10.00	100	\$185.25	Pcs	P1425	EG	3/8"	9.00	100	\$180.40	Pcs
P1211	HG	1/2"	10.00	100	\$215.65	Pcs	P1425	SS	3/8"	9.00	100	CALL	Pcs
P1211	ZD	1/2"	10.00	100	\$185.25	Pcs	P1425AS	EG	3/8"	9.00	100	\$214.15	Pcs
P1211AS	EG	1/2"	10.00	100	\$227.40	Pcs	P1426	EG	1/2"	11.00	100	\$184.00	Pcs
P1212	EG	3/4"	11.00	100	\$187.55	Pcs	P1426	HG	1/2"	22.00	100	\$263.35	Pcs
P1212	HG	3/4"	11.60	100	\$231.45	Pcs	P1426	ZD	1/2"	11.00	100	\$184.00	Pcs
P1212	ZD	3/4"	11.00	100	\$187.55	Pcs	P1426	AL	1/2"	3.70	100	CALL	Pcs
P1212	SS	3/4"	10.00	100	CALL	Pcs	P1426	SS	1/2"	11.00	100	CALL	Pcs
P1212AS	EG	3/4"	11.00	100	\$229.85	Pcs	P1426AS	EG	1/2"	11.00	100	\$215.20	Pcs
P1213	EG	1"	12.00	100	\$208.95	Pcs	P1426AS	ZD	1/2"	11.00	100	\$215.20	Pcs
P1213	HG	1"	12.60	100	\$250.40	Pcs	P1427	EG	3/4"	12.00	100	\$195.75	Pcs
P1213	ZD	1"	12.00	100	\$208.95	Pcs	P1427	HG	3/4"	13.00	100	\$252.15	Pcs
P1213AS	EG	1"	12.00	100	\$233.10	Pcs	P1427	ZD	3/4"	12.00	100	\$195.75	Pcs
P1214	EG	1-1/4"	18.00	100	\$250.50	Pcs	P1427	AL	3/4"	4.00	100	CALL	Pcs
P1214	HG	1-1/4"	19.00	100	\$310.70	Pcs	P1427	SS	3/4"	12.00	100	CALL	Pcs
P1214	ZD	1-1/4"	18.00	100	\$250.50	Pcs	P1427AS	EG	3/4"	12.00	100	\$218.05	Pcs
P1214AS	EG	1-1/4"	18.00	100	\$292.90	Pcs	P1427AS	ZD	3/4"	12.00	100	\$218.05	Pcs
P1215	EG	1-1/2"	20.00	100	\$275.95	Pcs	P1428	EG	1"	15.00	100	\$219.20	Pcs
P1215	HG	1-1/2"	21.00	100	\$339.00	Pcs	P1428	HG	1"	16.00	100	\$257.90	Pcs
P1215	ZD	1-1/2"	20.00	100	\$275.95	Pcs	P1428	ZD	1"	15.00	100	\$219.20	Pcs
P1215AS	EG	1-1/2"	20.00	100	\$294.65	Pcs	P1428	AL	1"	5.00	100	CALL	Pcs
P1217	EG	2"	22.00	100	\$309.75	Pcs	P1428	SS	1"	15.00	100	CALL	Pcs
P1217	HG	2"	24.00	100	\$343.60	Pcs	P1428AS	EG	1"	15.00	100	\$242.65	Pcs
P1217	ZD	2"	22.00	100	\$309.75	Pcs	P1428AS	ZD	1"	15.00	100	\$242.65	Pcs
P1217AS	EG	2"	22.00	100	\$330.20	Pcs	P1429	EG	1-1/4"	18.00	100	\$244.75	Pcs
							P1429	ZD	1-1/4"	70.00	100	\$244.75	Pcs
							P1429	AL	1-1/4"	6.00	100	CALL	Pcs
							P1429	SS	1-1/4"	18.00	100	CALL	Pcs
							P1429AS	EG	1-1/4"	18.00	100	\$265.20	Pcs
							P1429AS	ZD	1-1/4"	18.00	100	\$265.20	Pcs
							P1430	EG	1-1/2"	29.00	100	\$303.40	Pcs
							P1430	ZD	1-1/2"	71.00	100	\$303.40	Pcs
							P1430	SS	1-1/2"	29.00	50	CALL	Pcs
							P1430AS	EG	1-1/2"	29.00	100	\$338.90	Pcs
							P1430AS	ZD	1-1/2"	29.00	100	\$338.90	Pcs
							P1431	EG	2"	33.00	100	\$322.80	Pcs
							P1431	HG	2"	35.00	50	\$420.40	Pcs
							P1431	ZD	2"	33.00	100	\$322.80	Pcs
							P1431	AL	2"	11.00	50	CALL	Pcs
							P1431	SS	2"	33.00	100	CALL	Pcs
							P1431AS	EG	2"	33.00	100	\$360.00	Pcs
							P1431AS	ZD	2"	33.00	100	\$360.00	Pcs

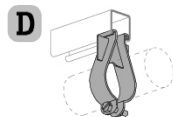

P1563	EG	3/8"	27.00	50	\$992.85	Pcs
P1564	EG	1/2"	29.00	50	\$1,044.00	Pcs
P1565	EG	3/4"	30.00	50	\$1,098.65	Pcs
P1566	EG	1"	31.00	50	\$1,157.10	Pcs
P1567	EG	1-1/4"	38.00	50	\$1,217.25	Pcs
P1568	EG	1-1/2"	40.00	50	\$1,281.15	Pcs
P1569	EG	2"	47.00	50	\$1,346.95	Pcs
P1570	EG	2-1/2"	66.00	25	\$1,427.95	Pcs
P1571	EG	3"	78.00	25	\$1,508.65	Pcs
P1572	EG	3-1/2"	87.00	25	\$1,806.75	Pcs
P1573	EG	4"	90.00	25	\$1,720.25	Pcs

AL-Alum.; CP-Cadmium Plated; EA- Extruded Alum.; EG-Electro-Galv.; EV-Everdur; FG-Fiberglass Reinforced Polyester; GR-Perma-Green; GY-Gray; HG-Hot Dip Galv.; MA-Maple; WH-White; NC-No Closure Strip; W/End Caps and Back Plates; PL-Plain; PG-Pre-Galv.; PO-Porcelain; SS-Stainless 304; ST-Stainless 316; WC-W/Closure Strip, End Caps and Back Plates; X-No Closure Strip or End Caps, W/Back Plates; ZD-Yellow Zinc Dichromate
 Note: For part details and loading information refer to the current Unistrut General Engineering Catalog.

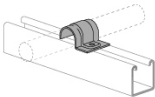
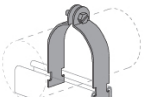
Part No.	Fin.	Size	Wt/100	Std Qty	\$/100	UM	Part No.	Fin.	Size	Wt/100	Std Qty	\$/100	UM
B							B						
P2008	EG	1/4"	4.00	100	\$250.15	Pcs	P2024	EG	1/4"	8.00	100	\$240.10	Pcs
P2008	EG	1/4"	4.00	100	\$250.15	Pcs	P2024	HG	1/4"	8.50	100	\$246.00	Pcs
P2008	HG	1/4"	4.20	100	\$281.80	Pcs	P2024	CC	1/4"	8.00	100	\$305.75	Pcs
P2008	SS	1/4"	4.00	100	CALL	Pcs	P2024	AL	1/4"	2.70	100	CALL	Pcs
P2009	EG	5/16"	5.00	100	\$251.80	Pcs	P2024	SS	1/4"	8.00	100	CALL	Pcs
P2009	HG	5/16"	5.30	100	\$283.45	Pcs	P2024	ST	1/4"	8.00	100	CALL	Pcs
P2009	SS	5/16"	5.00	100	CALL	Pcs	P2025	EG	3/8"	8.00	100	\$247.15	Pcs
P2010	EG	3/8"	5.00	100	\$253.05	Pcs	P2025	HG	3/8"	8.50	100	\$253.65	Pcs
P2010	HG	3/8"	5.30	100	\$284.70	Pcs	P2025	CC	3/8"	8.00	100	\$311.25	Pcs
P2010	SS	3/8"	5.00	100	CALL	Pcs	P2025	AL	3/8"	2.80	100	CALL	Pcs
P2012	EG	1/2"	6.00	100	\$257.90	Pcs	P2025	SS	3/8"	8.00	100	CALL	Pcs
P2012	HG	1/2"	6.40	100	\$286.90	Pcs	P2025	ST	3/8"	8.00	100	CALL	Pcs
P2012	SS	1/2"	6.00	100	CALL	Pcs	P2026	EG	1/2"	9.00	100	\$252.35	Pcs
P2014	EG	5/8"	8.00	100	\$271.65	Pcs	P2026	HG	1/2"	9.50	100	\$257.90	Pcs
P2014	HG	5/8"	8.50	100	\$297.75	Pcs	P2026	CC	1/2"	9.00	100	\$330.45	Pcs
P2014	SS	5/8"	8.00	100	CALL	Pcs	P2026	AL	1/2"	3.00	100	CALL	Pcs
P2016	EG	3/4"	9.00	100	\$260.35	Pcs	P2026	SS	1/2"	9.00	100	CALL	Pcs
P2016	HG	3/4"	9.50	100	\$265.20	Pcs	P2026	ST	1/2"	9.00	100	CALL	Pcs
P2016	SS	3/4"	9.00	100	CALL	Pcs	P2027	EG	5/8"	10.00	100	\$255.00	Pcs
P2018	EG	7/8"	10.00	50	\$273.60	Pcs	P2027	HG	5/8"	10.60	100	\$262.05	Pcs
P2018	SS	7/8"	10.00	50	CALL	Pcs	P2027	CC	5/8"	10.00	100	\$341.20	Pcs
P2020	EG	1"	11.00	50	\$282.30	Pcs	P2027	AL	5/8"	3.30	100	CALL	Pcs
P2020	HG	1"	11.70	50	\$298.00	Pcs	P2027	SS	5/8"	10.00	100	CALL	Pcs
P2020	SS	1"	11.00	100	CALL	Pcs	P2027	ST	5/8"	10.00	100	CALL	Pcs
							P2027	PC	5/8"	10.00	100	\$2,515.25	Pcs
							P2028	EG	3/4"	11.00	100	\$262.75	Pcs
							P2028	HG	3/4"	11.70	100	\$269.35	Pcs
							P2028	CC	3/4"	11.00	100	\$352.05	Pcs
							P2028	AL	3/4"	3.70	100	CALL	Pcs
							P2028	SS	3/4"	11.00	100	CALL	Pcs
							P2028	ST	3/4"	11.00	100	CALL	Pcs
							P2028	PC	3/4"	28.00	100	\$2,515.25	Pcs
							P2029	EG	7/8"	12.00	100	\$275.00	Pcs
							P2029	HG	7/8"	12.70	100	\$278.60	Pcs
							P2029	CC	7/8"	12.00	100	\$366.95	Pcs
							P2029	AL	7/8"	4.00	100	CALL	Pcs
							P2029	SS	7/8"	12.00	100	CALL	Pcs
							P2029	ST	7/8"	12.00	100	CALL	Pcs
							P2029	PC	7/8"	12.00	100	\$2,521.35	Pcs
							P2030	EG	1"	14.00	100	\$306.65	Pcs
							P2030	HG	1"	14.80	100	\$310.10	Pcs
							P2030	CC	1"	15.00	100	\$375.70	Pcs
							P2030	AL	1"	7.00	100	CALL	Pcs
							P2030	SS	1"	14.00	100	CALL	Pcs
							P2030	ST	1"	14.00	100	CALL	Pcs
							P2030	PC	1"	14.00	100	\$2,545.85	Pcs
							P2031	EG	1-1/8"	15.00	100	\$313.80	Pcs
							P2031	HG	1-1/8"	16.00	100	\$362.00	Pcs
							P2031	CC	1-1/8"	15.00	100	\$386.35	Pcs
							P2031	AL	1-1/8"	5.00	100	CALL	Pcs
							P2031	SS	1-1/8"	15.00	100	CALL	Pcs
							P2032	EG	1-1/4"	16.00	100	\$318.10	Pcs
							P2032	HG	1-1/4"	16.00	100	\$334.15	Pcs
							P2032	CC	1-1/4"	16.00	100	\$416.40	Pcs
							P2032	AL	1-1/4"	6.00	100	CALL	Pcs
							P2032	SS	1-1/4"	16.00	100	CALL	Pcs
							P2032	ST	1-1/4"	16.00	100	CALL	Pcs
							P2033	EG	1-3/8"	17.00	100	\$328.70	Pcs
							P2033	HG	1-3/8"	18.00	100	\$345.70	Pcs
							P2033	CC	1-3/8"	17.00	100	\$427.00	Pcs
							P2033	AL	1-3/8"	5.70	100	CALL	Pcs
							P2033	SS	1-3/8"	17.00	100	CALL	Pcs
							P2034	EG	1-1/2"	18.00	100	\$336.10	Pcs
							P2034	HG	1-1/2"	18.00	100	\$386.70	Pcs
							P2034	CC	1-1/2"	18.00	100	\$438.00	Pcs
							P2034	AL	1-1/2"	7.00	100	CALL	Pcs
							P2034	SS	1-1/2"	18.00	100	CALL	Pcs
							P2035	EG	1-5/8"	19.00	100	\$342.55	Pcs
							P2035	HG	1-5/8"	20.00	100	\$438.65	Pcs
							P2035	CC	1-5/8"	19.00	100	\$454.95	Pcs

AL-Alum.; CP-Cadmium Plated; EA- Extruded Alum.; EG-Electro-Galv.; EV-Everdur; FG-Fiberglass Reinforced Polyester; GR-Perma-Green; GY-Gray; HG-Hot Dip Galv.; MA-Maple; WH-White; NC-No Closure Strip; W/End Caps and Back Plates; PL-Plain; PG-Pre-Galv.; PO-Porcelain; SS-Stainless 304; ST-Stainless 316; WC-W/Closure Strip, End Caps and Back Plates; X-No Closure Strip or End Caps, W/Back Plates; ZD-Yellow Zinc Dichromate
 Note: For part details and loading information refer to the current Unistrut General Engineering Catalog.

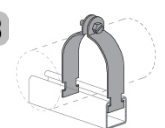
Part No.	Fin.	Size	Wt/100	Std Qty	\$/100 UM
B					
P2035	AL	1-5/8"	6.00	100	CALL Pcs
P2035	SS	1-5/8"	19.00	100	CALL Pcs
P2037	EG	1-7/8"	28.00	100	\$442.25 Pcs
P2037	CC	1-7/8"	28.00	100	\$774.65 Pcs
P2037	AL	1-7/8"	12.00	100	CALL Pcs
P2037	SS	1-7/8"	28.00	100	CALL Pcs
P2037	ST	1-7/8"	28.00	50	CALL Pcs
P2038	EG	2"	31.00	50	\$454.85 Pcs
P2038	HG	2"	31.00	50	\$592.05 Pcs
P2038	CC	2"	31.00	50	\$809.20 Pcs
P2038	AL	2"	10.00	50	CALL Pcs
P2038	SS	2"	31.00	50	CALL Pcs
P2039	EG	2-1/8"	32.00	50	\$468.00 Pcs
P2039	HG	2-1/8"	34.00	50	\$580.95 Pcs
P2039	CC	2-1/8"	32.00	50	\$860.70 Pcs
P2039	AL	2-1/8"	10.70	50	CALL Pcs
P2039	SS	2-1/8"	32.00	50	CALL Pcs
P2040	EG	2-1/4"	33.00	50	\$485.00 Pcs
P2040	CC	2-1/4"	33.00	50	\$899.15 Pcs
P2040	SS	2-1/4"	33.00	50	CALL Pcs
P2042	EG	2-1/2"	35.00	50	\$500.60 Pcs
P2042	HG	2-1/2"	42.00	50	\$568.50 Pcs
P2042	CC	2-1/2"	35.00	50	\$933.70 Pcs
P2042	AL	2-1/2"	11.00	50	CALL Pcs
P2042	SS	2-1/2"	35.00	50	CALL Pcs
P2043	EG	2-5/8"	37.00	50	\$518.35 Pcs
P2043	CC	2-5/8"	37.00	50	\$1,053.80 Pcs
P2043	SS	2-5/8"	37.00	50	CALL Pcs
P2044	EG	2-3/4"	38.00	50	\$524.95 Pcs
P2044	SS	2-3/4"	380.00	50	CALL Pcs
P2046	EG	3"	41.00	50	\$553.95 Pcs
P2046	CC	3"	41.00	50	\$1,141.85 Pcs
P2046	AL	3"	15.00	50	CALL Pcs
P2046	SS	3"	41.00	50	CALL Pcs
P2047	EG	3-1/8"	43.00	50	\$572.90 Pcs
P2047	CC	3-1/8"	43.00	50	\$1,202.00 Pcs
P2047	AL	3-1/8"	17.00	50	CALL Pcs
P2047	SS	3-1/8"	43.00	50	CALL Pcs
P2048	EG	3-1/4"	45.00	50	\$579.35 Pcs
P2048	AL	3-1/4"	17.00	50	CALL Pcs
P2049	EG	3-3/8"	46.00	50	\$596.80 Pcs
P2051	EG	3-5/8"	56.00	25	\$625.65 Pcs
P2051	HG	3-5/8"	59.00	50	\$737.45 Pcs
P2051	SS	3-5/8"	56.00	25	CALL Pcs
P2052	EG	3-3/4"	58.00	25	\$650.75 Pcs
P2053	EG	3-7/8"	60.00	25	\$775.00 Pcs
P2055	EG	4-1/8"	62.00	25	\$799.60 Pcs
P2055	CC	4-1/8"	62.00	25	\$1,466.05 Pcs
P2055	SS	4-1/8"	62.00	25	CALL Pcs
P2056	EG	4-1/4"	64.00	25	\$823.15 Pcs
P2056	SS	4-1/4"	64.00	25	CALL Pcs
P2057	EG	4-3/8"	66.00	25	\$853.30 Pcs
P2059	EG	4-5/8"	70.00	25	\$874.45 Pcs
P2059	HG	4-5/8"	74.00	25	\$927.00 Pcs
P2059	CC	4-5/8"	70.00	25	\$1,556.00 Pcs
P2059	AL	4-5/8"	25.00	25	CALL Pcs
P2059	SS	4-5/8"	70.00	50	CALL Pcs
P2060	EG	4-3/4"	72.00	25	\$892.70 Pcs
P2060	HG	4-3/4"	77.00	25	\$1,030.15 Pcs
P2061	EG	4-7/8"	73.00	25	\$909.45 Pcs
P2062	EG	5"	74.00	25	\$915.80 Pcs
P2062	AL	5"	26.00	25	CALL Pcs
P2062	SS	5"	74.00	25	CALL Pcs
P2063	EG	5-1/8"	76.00	25	\$938.90 Pcs
P2064	EG	5-1/4"	77.00	25	\$955.55 Pcs
P2065	EG	5-3/8"	78.00	25	\$970.20 Pcs
P2066	EG	5-1/2"	79.00	25	\$999.40 Pcs
P2066	SS	5-1/2"	79.00	25	CALL Pcs
P2067	EG	5-5/8"	88.00	25	\$1,071.60 Pcs
P2068	EG	5-3/4"	90.00	25	\$1,100.85 Pcs

(Continued from previous column)

P2068	SS	5-3/4"	90.00	25	CALL Pcs
P2069	EG	5-7/8"	92.00	25	\$1,117.25 Pcs
P2070	EG	6"	94.00	25	\$1,122.90 Pcs
P2070	AL	6"	35.00	25	CALL Pcs
P2070	SS	6"	94.00	25	CALL Pcs
P2070-61	EG	6-1/8"	96.00	25	\$1,152.70 Pcs
P2070-62	EG	6-1/4"	98.00	25	\$1,177.05 Pcs
P2070-63	EG	6-3/8"	99.00	25	\$1,202.60 Pcs
P2070-64	EG	6-1/2"	100.00	25	\$1,227.55 Pcs
P2070-66	EG	6-3/4"	104.00	25	\$1,257.55 Pcs
P2070-67	EG	6-7/8"	106.00	25	\$1,282.95 Pcs
P2070-70	EG	7"	108.00	25	\$1,301.90 Pcs
P2070-71	EG	7-1/8"	110.00	25	\$1,318.20 Pcs
P2070-72	EG	7-1/4"	112.00	25	\$1,334.25 Pcs
P2070-73	EG	7-3/8"	114.00	25	\$1,360.80 Pcs
P2070-74	EG	7-1/2"	116.00	25	\$1,374.10 Pcs
P2070-75	EG	7-5/8"	117.00	25	\$1,396.30 Pcs
P2070-76	EG	7-3/4"	119.00	25	\$1,412.70 Pcs
P2070-77	EG	7-7/8"	121.00	25	\$1,443.05 Pcs
P2070-80	EG	8"	123.00	25	\$1,454.05 Pcs
P2070-81	EG	8-1/8"	125.00	25	\$1,474.80 Pcs
P2070-82	EG	8-1/4"	126.00	25	\$1,490.85 Pcs
P2070-83	EG	8-3/8"	128.00	25	\$1,513.50 Pcs
P2070-84	EG	8-1/2"	129.00	25	\$1,538.00 Pcs
P2070-90	EG		128.00	25	\$5,086.50 Pcs
P2070-92	EG		132.00	25	\$8,195.40 Pcs
P2070-93	EG		151.00	25	\$8,248.80 Pcs

D



P2243	GR		40.00	25	\$614.35 Pcs
P2243	EG		40.00	25	\$614.35 Pcs
P2243	HG		42.40	25	\$606.25 Pcs

D



P2474	GR		268.00	10	\$6,788.75 Pcs
P2474	EG		268.00	10	\$6,788.75 Pcs
P2474	HG		271.00	10	\$7,836.70 Pcs

D



P2474-1	GR	6-3/4"	299.00	10	\$7,467.75 Pcs
P2474-1	EG	6-3/4"	299.00	10	\$7,467.75 Pcs
P2474-1	HG	6-3/4"	330.00	10	\$8,620.25 Pcs
P2474-2	GR	7-1/2"	304.00	10	\$8,214.35 Pcs
P2474-2	EG	7-1/2"	304.00	10	\$8,214.35 Pcs
P2474-2	HG	7-1/2"	330.00	10	\$9,480.95 Pcs
P2474-3	EG	8-1/2"	311.00	10	\$9,035.10 Pcs
P2474-3	HG	8-1/2"	330.00	10	\$10,429.05 Pcs
P2474-4	GR	9-9/16"	319.00	10	\$9,937.25 Pcs
P2474-4	EG	9-9/16"	319.00	10	\$9,937.25 Pcs
P2474-4	HG	9-9/16"	339.00	10	\$11,472.05 Pcs

D



P2475	GR		680.00	5	\$16,173.80 Pcs
P2475	EG		680.00	5	\$16,173.80 Pcs
P2475	HG		685.00	5	\$17,773.70 Pcs

D



P2476	EG		1046.00	10	\$22,184.20 Pcs
-------	----	--	---------	----	-----------------

AL-Alum.; CP-Cadmium Plated; EA- Extruded Alum.; EG-Electro-Galv.; EV-Everdur; FG-Fiberglass Reinforced Polyester; GR-Perma-Green; GY-Gray; HG-Hot Dip Galv.; MA-Maple; WH-White; NC-No Closure Strip; W/End Caps and Back Plates; PL-Plain; PG-Pre-Galv.; PO-Porcelain; SS-Stainless 304; ST-Stainless 316; WC-W/Closure Strip, End Caps and Back Plates; X-No Closure Strip or End Caps, W/Back Plates; ZD-Yellow Zinc Dichromate
 Note: For part details and loading information refer to the current Unistrut General Engineering Catalog.

Part No. Fin. Size Wt/100 Std Qty \$/100 UM

D 					
P2476	EG		1046.00	10	\$22,184.20 Pcs

D 					
P2481	GR		90.00	25	\$1,111.35 Pcs
P2481	HG		95.40	25	\$1,257.80 Pcs

D 					
P2482	GR		139.00	10	\$1,639.75 Pcs
P2482	EG		139.00	10	\$1,639.75 Pcs
P2482	HG		147.30	10	\$1,845.10 Pcs

Part No. Fin. Size Wt/100 Std Qty \$/100 UM

B 					
P2558-05	GR	1/2"	23.00	50	\$613.55 Pcs
P2558-05	EG	1/2"	23.00	50	\$613.55 Pcs
P2558-05	HG	1/2"	24.30	50	\$631.65 Pcs
P2558-05	AL	1/2"	3.00	50	CALL Pcs
P2558-05	SS	1/2"	23.00	50	CALL Pcs
P2558-07	GR	3/4"	26.00	50	\$651.20 Pcs
P2558-07	EG	3/4"	26.00	50	\$651.20 Pcs
P2558-07	HG	3/4"	27.50	50	\$670.15 Pcs
P2558-07	AL	3/4"	9.00	50	CALL Pcs
P2558-07	SS	3/4"	26.00	50	CALL Pcs
P2558-10	GR	1"	31.00	25	\$691.95 Pcs
P2558-10	EG	1"	31.00	25	\$691.95 Pcs
P2558-10	HG	1"	32.80	25	\$712.65 Pcs
P2558-10	AL	1"	10.00	25	CALL Pcs
P2558-10	SS	1"	31.00	25	CALL Pcs
P2558-12	GR	1-1/4"	35.00	25	\$717.50 Pcs
P2558-12	EG	1-1/4"	35.00	25	\$717.50 Pcs
P2558-12	HG	1-1/4"	37.10	25	\$739.20 Pcs
P2558-12	SS	1-1/4"	35.00	25	CALL Pcs
P2558-15	GR	1-1/2"	39.00	25	\$725.00 Pcs
P2558-15	EG	1-1/2"	39.00	25	\$725.00 Pcs
P2558-15	HG	1-1/2"	41.30	25	\$756.40 Pcs
P2558-15	AL	1-1/2"	13.00	25	CALL Pcs
P2558-15	SS	1-1/2"	39.00	25	CALL Pcs
P2558-20	GR	2"	94.00	25	\$1,147.70 Pcs
P2558-20	EG	2"	94.00	25	\$1,147.70 Pcs
P2558-20	HG	2"	99.60	25	\$1,220.15 Pcs
P2558-20	AL	2"	35.00	25	CALL Pcs
P2558-20	SS	2"	94.00	25	CALL Pcs
P2558-20	ST	2"	94.00	25	CALL Pcs
P2558-25	GR	2-1/2"	114.00	25	\$1,211.60 Pcs
P2558-25	EG	2-1/2"	114.00	25	\$1,211.60 Pcs
P2558-25	HG	2-1/2"	120.80	25	\$1,343.85 Pcs
P2558-25	AL	2-1/2"	41.00	25	CALL Pcs
P2558-25	SS	2-1/2"	114.00	25	CALL Pcs
P2558-30	GR	3"	133.00	25	\$1,458.75 Pcs
P2558-30	EG	3"	133.00	25	\$1,458.75 Pcs
P2558-30	HG	3"	140.90	25	\$1,489.05 Pcs
P2558-30	SS	3"	133.00	25	CALL Pcs
P2558-30	ST	3"	133.00	25	CALL Pcs
P2558-35	GR	3-1/2"	152.00	25	\$1,581.55 Pcs
P2558-35	EG	3-1/2"	152.00	25	\$1,581.55 Pcs
P2558-35	HG	3-1/2"	161.10	25	\$1,616.65 Pcs
P2558-35	SS	3-1/2"	152.00	25	CALL Pcs
P2558-35	ST	3-1/2"	152.00	25	CALL Pcs
P2558-40	GR	4"	176.00	25	\$1,682.85 Pcs
P2558-40	EG	4"	176.00	25	\$1,682.85 Pcs
P2558-40	HG	4"	186.50	25	\$1,857.35 Pcs
P2558-40	SS	4"	164.00	25	CALL Pcs
P2558-40	ST	4"	164.00	25	CALL Pcs
P2558-50	GR	5"	198.00	20	\$2,066.40 Pcs
P2558-50	EG	5"	198.00	20	\$2,066.40 Pcs
P2558-50	HG	5"	209.80	20	\$2,212.50 Pcs
P2558-50	SS	5"	198.00	20	CALL Pcs
P2558-50	ST	5"	198.00	20	CALL Pcs
P2558-60	GR	6"	225.00	20	\$2,292.10 Pcs
P2558-60	EG	6"	225.00	20	\$2,292.10 Pcs
P2558-60	HG	6"	238.50	20	\$2,653.15 Pcs
P2558-60	SS	6"	228.00	20	CALL Pcs
P2558-60	ST	6"	228.00	20	CALL Pcs

D 					
P2600			250.00	1	\$18,383.90 Pcs

AL-Alum.; CP-Cadmium Plated; EA- Extruded Alum.; EG-Electro-Galv.; EV-Everdur; FG-Fiberglass Reinforced Polyester; GR-Perma-Green; GY-Gray; HG-Hot Dip Galv.; MA-Maple; WH-White; NC-No Closure Strip; W/End Caps and Back Plates; PL-Plain; PG-Pre-Galv.; PO-Porcelain; SS-Stainless 304; ST-Stainless 316; WC-W/Closure Strip, End Caps and Back Plates; X-No Closure Strip or End Caps, W/Back Plates; ZD-Yellow Zinc Dichromate
 Note: For part details and loading information refer to the current Unistrut General Engineering Catalog.

Part No. Fin. Size Wt/100 Std Qty \$/100 UM Part No. Fin. Size Wt/100 Std Qty \$/100 UM

D



P2426	SS	1/2"	1.70	100	CALL	Pcs
P2427	SS	3/4"	2.40	100	CALL	Pcs
P2428	SS	1"	3.60	100	CALL	Pcs
P2429	SS	1-1/4"	4.60	100	CALL	Pcs
P2430	SS	1-1/2"	5.90	100	CALL	Pcs
P2431	SS	2"	8.00	100	CALL	Pcs
P2609	SS	3/8"	1.60	200	CALL	Pcs
P2611	SS	1/2"	2.30	200	CALL	Pcs
P2612	SS	3/4"	3.20	200	CALL	Pcs
P2613	SS	1"	4.10	100	CALL	Pcs
P2614	SS	1-1/4"	5.10	100	CALL	Pcs
P2615	SS	1-1/2"	6.30	100	CALL	Pcs
P2617	SS	2"	10.00	100	CALL	Pcs

B









P3409	EG	3/8"	14.00	100	\$627.15	Pcs
P3411	EG	1/2"	15.00	100	\$577.05	Pcs
P3411	CC	1/2"	15.00	100	\$850.65	Pcs
P3411	SS	1/2"	15.00	100	CALL	Pcs
P3412	EG	3/4"	19.00	100	\$590.45	Pcs
P3412	SS	3/4"	19.00	50	CALL	Pcs
P3413	EG	1"	22.00	100	\$629.35	Pcs
P3413	CC	1"	22.00	50	\$910.60	Pcs
P3413	SS	1"	22.00	50	CALL	Pcs
P3414	EG	1-1/4"	34.00	50	\$687.80	Pcs
P3414	CC	1-1/4"	34.00	50	\$1,144.50	Pcs
P3415	EG	1-1/2"	49.00	50	\$777.10	Pcs
P3415	CC	1-1/2"	49.00	50	\$1,100.35	Pcs
P3417	EG	2"	55.00	25	\$1,035.10	Pcs
P3417	HG	2"	58.00	50	\$1,141.85	Pcs
P3417	CC	2"	55.00	50	\$1,505.10	Pcs



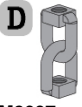
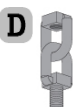

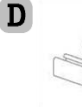
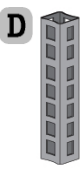

D













UB1	PA	1"	12.00	25	\$1,854.80	Pcs
UB1-1/2	PA	1-1/2"	36.00	10	\$2,425.60	Pcs
UB1-1/4	PA	1-1/4"	32.00	10	\$2,425.60	Pcs
UB1/2	PA	1/2"	9.00	25	\$1,734.25	Pcs
UB10	PA	10"	492.00	10	\$22,104.50	Pcs
UB2	PA	2"	42.00	10	\$2,645.05	Pcs
UB2-1/2	PA	2-1/2"	72.00	10	\$3,259.65	Pcs
UB3	PA	3"	84.00	25	\$3,632.80	Pcs
UB3-1/2	PA	3-1/2"	93.00	25	\$3,929.10	Pcs
UB3/4	PA	3/4"	10.00	25	\$1,800.05	Pcs
UB4	PA	4"	102.00	25	\$4,170.60	Pcs
UB5	PA	5"	123.00	10	\$5,839.00	Pcs
UB6	PA	6"	123.00	10	\$8,253.75	Pcs
UB8	PA	8"	243.00	10	\$14,928.60	Pcs

AL-Alum.; CP-Cadmium Plated; EA- Extruded Alum.; EG-Electro-Galv.; EV-Everdur; FG-Fiberglass Reinforced Polyester; GR-Perma-Green; GY-Gray; HG-Hot Dip Galv.; MA-Maple; WH-White; NC-No Closure Strip; W/End Caps and Back Plates; PL-Plain; PG-Pre-Galv.; PO-Porcelain; SS-Stainless 304; ST-Stainless 316; WC-W/Closure Strip, End Caps and Back Plates; X-No Closure Strip or End Caps, W/Back Plates; ZD-Yellow Zinc Dichromate
 Note: For part details and loading information refer to the current Unistrut General Engineering Catalog.



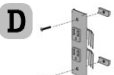

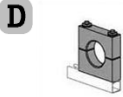

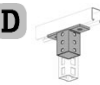
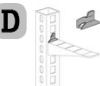
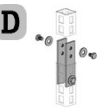
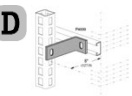
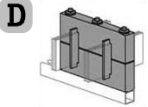



Part No.	Fin.	Size	Wt/100	Std Qty	\$/100	UM
						
M2037	EG	3/8"-16	23.00	50	\$3,950.90	Pcs
M2050	EG	1/2"-13	79.00	50	\$6,113.90	Pcs
						
M2137	EG	3/8"-16	27.00	50	\$5,331.85	Pcs
M2150	EG	1/2"-13	45.00	50	\$6,292.10	Pcs
						
M2250	EG	1/2"-13	25.00	50	\$3,943.65	Pcs
						
M2350	EG	1/2"-13	20.00	50	\$3,397.65	Pcs
						
P4280W	EG		5.00	100	\$427.25	Pcs
P5280W	EG		30.00	50	\$638.85	Pcs
						
P1690	MA	0 - 5/8"	24.00	0	CALL	Pcs
P1691	MA	1/2" - 1"	42.00	0	CALL	Pcs
P1692	MA	3/4" - 1-1/2"	54.00	0	CALL	Pcs
P1693	MA	1-1/4" - 1-3/4"	65.00	0	CALL	Pcs
P1694	MA	1-1/2" - 2-1/4"	84.00	0	CALL	Pcs
P1695	MA	2" - 2-1/2"	107.00	0	CALL	Pcs
P1696	MA	2-1/4" - 3"	123.00	0	CALL	Pcs
P1697	MA	3" - 4"	163.00	0	CALL	Pcs
						
P16F 20	PG	20 ft. len.	178.00	500	\$1,579.35	Ft
						
P1753	FG	2-13/16"	12.00	25	\$1,652.00	Pcs
P1753	PO	3"	82.00	25	\$2,158.80	Pcs
P1754	FG	3-3/4"	17.00	25	\$2,107.40	Pcs
P1754	PO	4"	95.00	25	\$2,158.80	Pcs





Part No.	Fin.	Size	Wt/100	Std Qty	\$/100	UM
						
P1787A	EV	3/8"	25.00	10	\$2,263.45	Pcs
P1787B	EV	1/2"	25.00	10	\$2,263.45	Pcs
P1787C	SS	5/8"	25.00	10	CALL	Pcs
P1787C	EV	5/8"	25.00	10	\$2,263.45	Pcs
P1788	EV	3/4"	37.00	10	\$2,993.90	Pcs
P1788A	EV	7/8"	37.00	10	\$2,993.90	Pcs
P1788B	EV	1"	37.00	10	\$2,993.90	Pcs
P1788C	EV	1-1/8"	37.00	10	\$2,993.90	Pcs
P1789	EV	1-1/4"	58.00	10	\$3,838.20	Pcs
P1789A	EV	1-3/8"	58.00	10	\$3,838.20	Pcs
P1789B	EV	1-1/2"	58.00	10	\$3,838.20	Pcs
P1789C	SS	1-5/8"	58.00	10	CALL	Pcs
P1789C	EV	1-5/8"	58.00	10	\$3,838.20	Pcs
P1790	SS	1-3/4"	76.00	10	CALL	Pcs
P1790	EV	1-3/4"	76.00	10	\$4,936.80	Pcs
P1790A	SS	1-7/8"	76.00	10	CALL	Pcs
P1790A	EV	1-7/8"	76.00	10	\$4,936.80	Pcs
P1790B	EV	2"	76.00	10	\$4,936.80	Pcs
P1790C	EV	2-1/8"	76.00	5	\$4,936.80	Pcs
P1791	SS	2-1/4"	90.00	5	CALL	Pcs
P1791	EV	2-1/4"	90.00	5	\$6,052.30	Pcs
P1791A	EV	2-3/8"	90.00	5	\$6,052.30	Pcs
P1791B	EV	2-1/2"	90.00	5	\$6,052.30	Pcs
P1791C	EV	2-5/8"	90.00	5	\$6,052.30	Pcs
P1792	SS	2-3/4"	109.00	5	CALL	Pcs
P1792	EV	2-3/4"	109.00	5	\$6,965.55	Pcs
P1792A	EV	2-7/8"	109.00	5	\$6,965.55	Pcs
P1792B	EV	3"	109.00	5	\$7,014.45	Pcs
P1793	EV	3-1/4"	130.00	5	\$7,913.95	Pcs
P1793A	EV	3-3/8"	130.00	5	\$7,913.95	Pcs
P1793B	EV	3-1/2"	130.00	5	\$7,913.95	Pcs
P1793C	EV	3-5/8"	130.00	5	\$7,913.95	Pcs
P1794	EV	3-3/4"	160.00	5	\$9,058.20	Pcs
P1795	EV	4-1/4"	160.00	5	\$9,468.80	Pcs
P1795B	EV	4-1/2"	160.00	5	\$9,468.80	Pcs
						
P2521-100	EG	1"	24.00	50	\$1,617.90	Pcs
						
P2521-50	EG	1/2"	27.00	50	\$657.75	Pcs
P2521-75	EG	3/4"	26.00	50	\$657.75	Pcs
						
P2522	GR		35.00	50	\$845.25	Pcs
P2522	EG		35.00	50	\$845.25	Pcs
						
P2534-50	EG	1/2"	96.00	20	\$4,297.05	Pcs
P2534-75	EG	3/4"	96.00	20	\$4,615.50	Pcs
						
P2535	EG		28.00	50	\$1,087.10	Pcs
						
P2536	EG		36.00	25	\$679.70	Pcs

AL-Alum.; CP-Cadmium Plated; EA- Extruded Alum.; EG-Electro-Galv.; EV-Everdur; FG-Fiberglass Reinforced Polyester; GR-Perma-Green; GY-Gray; HG-Hot Dip Galv.; MA-Maple; WH-White; NC-No Closure Strip; W/End Caps and Back Plates; PL-Plain; PG-Pre-Galv.; PO-Porcelain; SS-Stainless 304; ST-Stainless 316; WC-W/Closure Strip, End Caps and Back Plates; X-No Closure Strip or End Caps, W/Back Plates; ZD-Yellow Zinc Dichromate
 Note: For part details and loading information refer to the current Unistrut General Engineering Catalog.

Part No.	Fin.	Size	Wt/100	Std Qty	\$/100 UM	Part No.	Fin.	Size	Wt/100	Std Qty	\$/100 UM
 P2537	EG	2-7/16"	17.00	100	\$671.65 Pcs		MA	1" - 1-1/2"	38.00	0	CALL Pcs
P5537	GR	3-1/4"	20.00	100	\$788.30 Pcs	P2649C	MA	1-1/2" - 2"	47.00	0	CALL Pcs
	GR	1-3/4"	17.00	100	\$701.65 Pcs	P2649D	MA	2" - 2-1/2"	57.00	0	CALL Pcs
P2539	EG	1-3/4"	17.00	100	\$701.65 Pcs	P2649E	MA	2-1/2" - 3"	68.00	0	CALL Pcs
P3539	EG	1-1/2"	15.00	100	\$777.10 Pcs	P2649F	MA	3" - 3-1/2"	80.00	0	CALL Pcs
P5539	EG	2-9/16"	18.00	100	\$861.85 Pcs	P2649G	MA	3-1/2" - 4"	94.00	0	CALL Pcs
	EG	1-5/64"	10.00	100	\$775.00 Pcs		GR	9/16"	44.00	100	\$804.00 Pcs
P2540A	EG	5/8"	8.00	100	\$715.75 Pcs	P2755	EG	9/16"	44.00	100	\$804.00 Pcs
	EG		24.00	25	\$611.10 Pcs	P2756	EG	7/8"	44.00	100	\$768.20 Pcs
	PL		1.00	10	\$122.30 Pcs	P2757	GR	13/32"	44.00	100	\$768.20 Pcs
	WH		38.00	25	\$5,766.20 Pcs		EG		85.00	25	\$1,481.40 Pcs
	MA	0 - 1"	84.00	0	CALL Pcs		EG		30.00	25	\$337.70 Pcs
P2645B	MA	1" - 1-1/2"	102.00	0	CALL Pcs		AL		36.00	25	CALL Pcs
P2645C	MA	1-1/2" - 2"	121.00	0	CALL Pcs		EG		116.00	25	\$2,657.75 Pcs
P2645D	MA	2" - 2-1/2"	165.00	0	CALL Pcs	P2940	EG		148.00	20	\$6,512.10 Pcs
P2645E	MA	2-1/2" - 3"	189.00	0	CALL Pcs		EG		3.00	100	\$140.20 Pcs
P2645F	MA	3" - 3-1/2"	215.00	0	CALL Pcs		EG		97.00	25	\$1,583.50 Pcs
P2645G	MA	3-1/2" - 4"	243.00	0	CALL Pcs	P2932	EG		122.00	25	\$1,652.90 Pcs
P2645H	MA	Over 4"	0.00	0	CALL Pcs		EG		66.00	25	\$1,113.65 Pcs
	MA	No. Bus 0	421.00	0	CALL Pcs						
P2547B	MA	No. Bus 4	509.00	0	CALL Pcs						
P2547B	MA	No. Bus 2	465.00	0	CALL Pcs						
P2547C	MA	No. Bus 6	553.00	0	CALL Pcs						
P2547D	MA	No. Bus 8	597.00	0	CALL Pcs						
P2547E	MA	No. Bus 10	631.00	0	CALL Pcs						

AL-Alum.; CP-Cadmium Plated; EA- Extruded Alum.; EG-Electro-Galv.; EV-Everdur; FG-Fiberglass Reinforced Polyester; GR-Perma-Green; GY-Gray; HG-Hot Dip Galv.; MA-Maple; WH-White; NC-No Closure Strip; W/End Caps and Back Plates; PL-Plain; PG-Pre-Galv.; PO-Porcelain; SS-Stainless 304; ST-Stainless 316; WC-W/Closure Strip, End Caps and Back Plates; X-No Closure Strip or End Caps, W/Back Plates; ZD-Yellow Zinc Dichromate
 Note: For part details and loading information refer to the current Unistrut General Engineering Catalog.

Part No.	Fin.	Size	Wt/100	Std Qty	\$/100 UM
 D					
P2855	GR	9/16"	32.00	100	\$786.00 Pcs
P2855	EG	9/16"	32.00	100	\$786.00 Pcs
P2856	GR	7/8"	32.00	100	\$791.30 Pcs
P2856	EG	7/8"	32.00	100	\$791.30 Pcs
P2857	GR	13/32"	32.00	100	\$783.45 Pcs
P2857	EG	13/32"	32.00	100	\$783.45 Pcs
 D					
P2900	AL		20.00	50	\$1,960.25 Pcs
 D					
P2901	AL		35.00	20	\$5,754.20 Pcs
 D					
P2902	AL		27.00	25	\$4,126.95 Pcs
 D					
P2903	AL		45.00	25	\$6,121.40 Pcs
 D					
P2904	AL		12.00	25	\$1,533.25 Pcs
 D					
P2920	GR	5-1/2"	86.00	20	\$2,482.45 Pcs
P2920	HG	5-1/2"	91.20	20	\$2,503.35 Pcs
P2921	GR	8-1/4"	117.00	20	\$2,589.30 Pcs
P2921	HG	8-1/4"	124.00	20	\$2,695.65 Pcs
P2922	GR	11"	260.00	20	\$4,231.10 Pcs
P2922	HG	11"	275.60	20	\$4,632.25 Pcs
P2923	HG	13-3/4"	318.00	20	\$5,278.35 Pcs
P2924	GR	19-1/4"	390.00	20	\$5,248.90 Pcs
P2924	HG	19-1/4"	413.40	20	\$5,817.60 Pcs
 D					
P2929	HG	12"	286.20	10	\$4,610.05 Pcs
P2930	HG	18"	326.40	10	\$5,522.65 Pcs
 D					
P3116-125	EG		11.00	100	\$783.80 Pcs
 D					
P3521-50	EG		27.00	50	\$1,100.60 Pcs
 D					
P3922	GR	1-5/8"	100.00	50	\$2,669.65 Pcs
P3922	EG	1-5/8"	100.00	50	\$2,669.65 Pcs
P3923	GR	1-3/8"	97.00	50	\$3,015.80 Pcs
P3923	EG	1-3/8"	97.00	50	\$3,015.80 Pcs
P3924	GR	13/16"	80.00	50	\$2,981.40 Pcs
P3924	EG	13/16"	80.00	50	\$2,981.40 Pcs
P3925	GR	1-5/8"	103.00	50	\$3,242.45 Pcs
P3926	GR	1-5/8"	103.00	50	\$3,245.45 Pcs
P3926	EG	1-5/8"	103.00	50	\$3,245.45 Pcs

Part No.	Fin.	Size	Wt/100	Std Qty	\$/100 UM
 D					
P5021-100	EG	1"	28.00	50	\$1,857.70 Pcs
 D					
P5021-50	EG	1/2"	31.00	100	\$773.05 Pcs
P5021-75	EG	3/4"	30.00	100	\$782.65 Pcs
 D					
P5521-100	EG	1"	24.00	50	\$1,688.25 Pcs
 D					
P5521-50	EG	1/2"	27.00	100	\$676.35 Pcs
P5521-75	EG	3/4"	26.00	100	\$676.35 Pcs

AL-Alum.; CP-Cadmium Plated; EA- Extruded Alum.; EG-Electro-Galv.; EV-Everdur; FG-Fiberglass Reinforced Polyester; GR-Perma-Green; GY-Gray; HG-Hot Dip Galv.; MA-Maple; WH-White; NC-No Closure Strip; W/End Caps and Back Plates; PL-Plain; PG-Pre-Galv.; PO-Porcelain; SS-Stainless 304; ST-Stainless 316; WC-W/Closure Strip, End Caps and Back Plates; X-No Closure Strip or End Caps, W/Back Plates; ZD-Yellow Zinc Dichromate
 Note: For part details and loading information refer to the current Unistrut General Engineering Catalog.

Part No. Fin. Size Wt/100 Std Qty \$/100 UM

D						
M24	EG		52.00	100	\$521.60	Pcs

D						
M2506	EG	1/4"-20	13.00	100	\$244.85	Pcs
M2508	EG	3/8"-16	14.00	100	\$345.45	Pcs
M2510	EG	1/2"-13	14.00	100	\$332.05	Pcs
M2512	EG	5/8"-11	12.00	100	\$330.20	Pcs
M2523	EG	3/4"-10	11.00	100	\$387.95	Pcs
M2524	EG	7/8"-9	10.00	100	\$387.95	Pcs

D						
P3280W	EG		15.00	100	\$464.30	Pcs

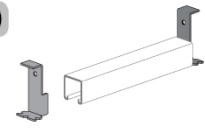
D						
P1703	PG	2-13/32"	30.00	100	\$196.00	Pcs
P1704	PG	3-17/32"	37.00	100	\$290.25	Pcs
P3703	EG	2-7/16"	20.00	100	\$224.75	Pcs
P3703	SS	2-7/16"	24.00	100	CALL	Pcs
P3704	EG	3"	20.00	100	\$237.10	Pcs
P3704	HG	3"	28.00	100	\$340.60	Pcs

D						
P2407	EG	w/P1000	10.00	100	\$112.50	Pcs
P3280	EG	w/P3000	8.00	400	\$79.45	Pcs
P3280	HG	w/P3000	8.50	400	\$243.25	Pcs
P3380	EG	w/P3300	5.00	500	\$76.80	Pcs
P3380	SS	w/P3300	5.00	500	CALL	Pcs

D						
P2865-10	PL	1"	2.00	500	\$185.70	Pcs
P2865-15	PL	1-1/2"	2.00	500	\$190.60	Pcs
P2865-20	PL	2"	2.00	500	\$195.65	Pcs

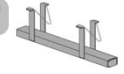
F						
P3165X	PG	10'	1650.00	10	\$15,344.05	Pcs
P3170WC	PG	20'	3240.00	10	\$35,164.90	Pcs
P3170X	PG	20'	174.00	440	\$1,652.25	Ft
P3170X	PL	20'	174.00	440	\$1,472.75	Ft
P3170X	SS	20'	165.00	200	CALL	Ft

F						
P3245	PG		54.00	50	\$563.20	Pcs



F						
P3245N4	EG	1/4"-20	6.00	200	\$906.20	Pcs
P3245N6	EG	3/8"-16	5.00	100	\$906.20	Pcs

Part No. Fin. Size Wt/100 Std Qty \$/100 UM

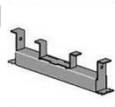

F						
P3249NC	PL	3"	85.00	50	\$684.45	Pcs
P3249WC	PG	3"	85.00	50	\$935.20	Pcs
P3249WC	PL	3"	85.00	50	\$723.50	Pcs
P3250NC	PG	4"	100.00	40	\$946.05	Pcs
P3250NC	PL	4"	100.00	40	\$878.60	Pcs
P3250WC	PG	4"	100.00	40	\$1,005.20	Pcs
P3250WC	PL	4"	100.00	40	\$936.35	Pcs
P3251NC	PL	6"	130.00	25	\$1,071.85	Pcs
P3251WC	PG	6"	130.00	25	\$1,300.30	Pcs
P3251WC	PL	6"	130.00	25	\$1,148.55	Pcs
P3252NC	PG	8"	159.00	20	\$1,486.25	Pcs
P3252NC	PL	8"	159.00	20	\$1,429.20	Pcs
P3252WC	PG	8"	159.00	20	\$1,669.55	Pcs
P3252WC	PL	8"	159.00	20	\$1,527.85	Pcs

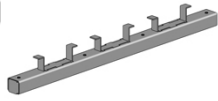
F						
P3253NC	PG	12"	227.00	10	\$2,228.45	Pcs
P3253NC	PL	12"	227.00	10	\$2,141.15	Pcs
P3253WC	PG	12"	227.00	10	\$2,680.75	Pcs
P3253WC	PL	12"	227.00	10	\$2,261.70	Pcs

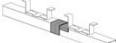

AL-Alum.; CP-Cadmium Plated; EA- Extruded Alum.; EG-Electro-Galv.; EV-Everdur; FG-Fiberglass Reinforced Polyester; GR-Perma-Green; GY-Gray; HG-Hot Dip Galv.; MA-Maple; WH-White; NC-No Closure Strip; W/End Caps and Back Plates; PL-Plain; PG-Pre-Galv.; PO-Porcelain; SS-Stainless 304; ST-Stainless 316; WC-W/Closure Strip, End Caps and Back Plates; X-No Closure Strip or End Caps, W/Back Plates; ZD-Yellow Zinc Dichromate
 Note: For part details and loading information refer to the current Unistrut General Engineering Catalog.

Part No.	Fin.	Size	Wt/100	Std Qty	\$/100	UM	Part No.	Fin.	Size	Wt/100	Std Qty	\$/100	UM
													
F							F						
P3254NC	PG	16"	270.00	10	\$2,443.65	Pcs	P3349NC	PG	3"	68.00	50	\$744.75	Pcs
P3254NC	PL	16"	270.00	10	\$2,328.25	Pcs	P3349NC	PL	3"	68.00	50	\$648.30	Pcs
P3254WC	PL	16"	270.00	10	\$2,488.55	Pcs	P3349WC	PG	3"	68.00	50	\$776.30	Pcs
P3255NC	PL	20"	357.00	10	\$2,517.20	Pcs	P3349WC	PL	3"	68.00	50	\$678.90	Pcs
P3255WC	PG	20"	357.00	10	\$2,860.95	Pcs	P3350NC	PG	4"	81.00	40	\$901.60	Pcs
P3255WC	PL	20"	357.00	10	\$2,718.65	Pcs	P3350NC	PL	4"	81.00	40	\$830.70	Pcs
P3256NC	PG	24"	399.00	10	\$2,877.00	Pcs	P3350WC	PL	4"	81.00	40	\$876.75	Pcs
P3256NC	PL	24"	399.00	10	\$2,702.60	Pcs	P3351NC	PG	6"	102.00	25	\$1,048.30	Pcs
P3256WC	PG	24"	399.00	10	\$4,046.65	Pcs	P3351NC	PL	6"	102.00	25	\$998.40	Pcs
P3256WC	PL	24"	399.00	10	\$2,943.50	Pcs	P3351WC	PG	6"	102.00	25	\$1,109.70	Pcs
P3257ANC	PL	36"	616.00	10	\$3,265.55	Pcs	P3351WC	PL	6"	102.00	25	\$1,060.30	Pcs
P3257AWC	PG	36"	616.00	10	\$5,055.80	Pcs							
P3257AWC	PL	36"	616.00	10	\$3,626.70	Pcs							
P3257NC	PG	32"	527.00	10	\$3,197.05	Pcs	P3352NC	PG	8"	122.00	20	\$1,398.70	Pcs
P3257NC	PL	32"	527.00	10	\$3,002.55	Pcs	P3352NC	PL	8"	122.00	20	\$1,331.85	Pcs
P3257WC	PG	32"	527.00	10	\$4,668.85	Pcs	P3352WC	PG	8"	122.00	20	\$1,476.80	Pcs
P3257WC	PL	32"	527.00	10	\$3,324.45	Pcs	P3352WC	PL	8"	122.00	20	\$1,409.35	Pcs
P3258NC	PG	40"	661.00	10	\$3,827.90	Pcs	P3353NC	PG	12"	174.00	10	\$2,096.45	Pcs
P3258NC	PL	40"	661.00	10	\$3,524.35	Pcs	P3353WC	PG	12"	174.00	10	\$2,192.20	Pcs
P3258WC	PG	40"	661.00	10	\$5,055.80	Pcs	P3353WC	PL	12"	174.00	10	\$2,090.80	Pcs
P3258WC	PL	40"	661.00	10	\$3,925.95	Pcs							
P3259NC	PG	4"	786.00	10	\$4,130.40	Pcs							
P3259NC	PL	4"	786.00	10	\$3,779.95	Pcs							
P3259WC	PG	4"	786.00	10	\$5,296.15	Pcs							
P3259WC	PL	4"	786.00	10	\$4,261.85	Pcs							
P3260NC	PL	5"	1003.00	10	\$4,724.40	Pcs							
P3260WC	PG	5"	1003.00	10	\$5,766.70	Pcs							
P3260WC	PL	5"	1003.00	10	\$5,328.00	Pcs							
P3260X	PG	5"	1003.00	10	\$6,453.55	Pcs							
P3261NC	PG	6"	1173.00	10	\$6,195.55	Pcs							
P3261NC	PL	6"	1173.00	10	\$5,670.95	Pcs							
P3261WC	PG	6"	1173.00	10	\$7,283.80	Pcs							
P3261WC	PL	6"	1173.00	10	\$6,392.80	Pcs							
P3262NC	PL	7"	1390.00	10	\$6,614.70	Pcs							
P3262WC	PG	7"	1390.00	10	\$8,071.15	Pcs							
P3263NC	PG	8"	1560.00	10	\$8,696.70	Pcs							
P3263NC	PL	8"	1560.00	10	\$7,560.05	Pcs							
P3263WC	PG	8"	1560.00	10	\$9,224.50	Pcs							
P3264NC	PL	9"	1741.00	10	\$8,504.75	Pcs							
P3264WC	PL	9"	1741.00	10	\$9,588.80	Pcs							
P3265NC	PG	10"	1947.00	20	\$10,871.00	Pcs							
P3265NC	PL	10"	1947.00	20	\$9,448.95	Pcs							
P3265WC	PG	10"	1947.00	20	\$12,138.15	Pcs							
P3265WC	PL	10"	1947.00	20	\$10,655.10	Pcs							
P3265X	PG	10"	1947.00	10	\$6,742.90	Pcs							
P3266NC	PL	12"	2334.00	10	\$11,339.45	Pcs							
P3266WC	PG	12"	2334.00	10	\$14,566.65	Pcs							
P3266WC	PL	12"	2334.00	10	\$12,785.95	Pcs							
P3267NC	PG	14"	2717.00	10	\$14,456.90	Pcs							
P3267NC	PL	14"	2717.00	10	\$13,228.80	Pcs							
P3267WC	PL	14"	2717.00	10	\$14,937.95	Pcs							
P3268NC	PG	16"	3116.00	10	\$16,523.10	Pcs							
P3268NC	PL	16"	3116.00	10	\$15,118.95	Pcs							
P3268WC	PG	16"	3116.00	10	\$19,422.95	Pcs							
P3268WC	PL	16"	3116.00	10	\$17,047.55	Pcs							
P3269NC	PG	18"	3530.00	10	\$18,588.35	Pcs							
P3269NC	PL	18"	3530.00	10	\$17,008.40	Pcs							
P3269WC	PG	18"	3530.00	10	\$20,756.85	Pcs							
P3269WC	PL	18"	3530.00	10	\$19,306.15	Pcs							
P3270NC	PL	20"	3882.00	20	\$19,893.25	Pcs							
P3270W	PG	20"	3400.00	10	\$16,686.50	Pcs							
P3270WC	PG	20"	3882.00	20	\$24,277.05	Pcs							
P3270X	PG	20"	193.00	500	\$889.25	Ft							
P3270X	HG	20"	204.60	500	\$1,276.50	Ft							
P3270X	PL	20"	193.00	500	\$829.85	Ft							
P3270X	SS	20"	193.00	500	CALL	Ft							





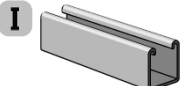
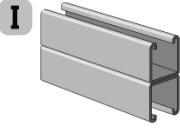
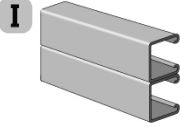
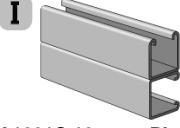

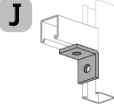
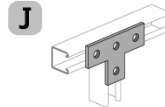
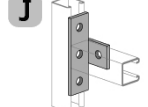
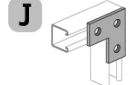
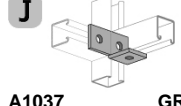
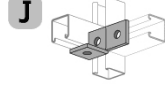
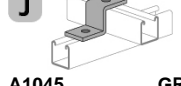
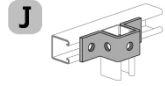
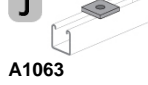
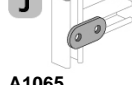
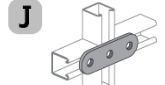

AL-Alum.; CP-Cadmium Plated; EA- Extruded Alum.; EG-Electro-Galv.; EV-Everdur; FG-Fiberglass Reinforced Polyester; GR-Perma-Green; GY-Gray; HG-Hot Dip Galv.; MA-Maple; WH-White; NC-No Closure Strip; W/End Caps and Back Plates; PL-Plain; PG-Pre-Galv.; PO-Porcelain; SS-Stainless 304; ST-Stainless 316; WC-W/Closure Strip, End Caps and Back Plates; X-No Closure Strip or End Caps, W/Back Plates; ZD-Yellow Zinc Dichromate
 Note: For part details and loading information refer to the current Unistrut General Engineering Catalog.

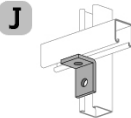
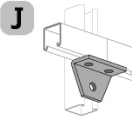
Part No.	Fin.	Size	Wt/100	Std Qty	\$/100	UM	Part No.	Fin.	Size	Wt/100	Std Qty	\$/100	UM
F 							(Continued from previous column)						
P3354NC	PG	16"	185.00	10	\$2,268.30	Pcs	P3370X	HG	20'	156.90	500	\$1,058.65	Ft
P3354NC	PL	16"	185.00	10	\$2,136.05	Pcs	P3370X	PL	20'	148.00	500	\$713.45	Ft
P3354WC	PG	16"	185.00	10	\$2,395.45	Pcs	P3370X	SS	20'	149.00	1000	CALL	Ft
P3354WC	PL	16"	185.00	10	\$2,261.85	Pcs	P3370X	ST	20'	149.00	1000	CALL	Ft
P3355NC	PG	20"	231.00	10	\$2,440.40	Pcs	D 						
P3355NC	PL	20"	231.00	10	\$2,274.20	Pcs	P3663	EG	w/P3270	10.00	50	\$273.85	Pcs
P3355WC	PG	20"	231.00	10	\$3,408.05	Pcs	P3663	SS	w/P3270	10.00	50	CALL	Pcs
P3355WC	PL	20"	231.00	10	\$2,434.75	Pcs	D 						
P3356NC	PG	24"	277.00	10	\$2,613.20	Pcs	P3700-37	EG	3/8"	89.00	0	\$1,059.15	Pcs
P3356NC	PL	24"	277.00	10	\$2,413.70	Pcs	P3700-50	EG	1/2"	111.00	0	\$1,212.75	Pcs
P3356WC	PG	24"	277.00	10	\$2,803.40	Pcs	P3700-62	EG	5/8"	141.00	0	\$1,431.05	Pcs
P3356WC	PL	24"	277.00	10	\$2,604.30	Pcs	F 						
P3357ANC	PG	36"	416.00	10	\$3,126.80	Pcs	P3754	HG		210.00	10	\$4,226.85	Pcs
P3357ANC	PL	36"	416.00	10	\$2,830.80	Pcs							
P3357AWC	PG	36"	416.00	10	\$3,412.00	Pcs							
P3357AWC	PL	36"	416.00	10	\$3,116.20	Pcs							
P3357NC	PL	32"	370.00	10	\$2,616.55	Pcs							
P3357NC	SS	32"	383.00	25	CALL	Pcs							
P3357WC	PG	32"	370.00	10	\$3,099.45	Pcs							
P3357WC	PL	32"	370.00	10	\$2,869.35	Pcs							
P3358NC	PG	40"	463.00	10	\$3,389.70	Pcs							
P3358NC	PL	40"	463.00	10	\$3,042.25	Pcs							
P3358WC	PG	40"	463.00	10	\$3,706.85	Pcs							
P3358WC	PL	40"	463.00	10	\$3,358.75	Pcs							
P3359NC	PG	4"	555.00	10	\$3,557.15	Pcs							
P3359NC	PL	4"	555.00	10	\$3,208.70	Pcs							
P3359WC	PL	4"	555.00	10	\$3,589.30	Pcs							
P3360NC	PG	5"	694.00	10	\$4,447.10	Pcs							
P3360NC	PL	5"	694.00	10	\$4,010.05	Pcs							
P3360WC	PG	5"	694.00	10	\$4,923.20	Pcs							
P3360WC	PL	5"	694.00	10	\$4,486.15	Pcs							
P3360X	SS	5"	557.00	25	CALL	Pcs							
P3361NC	PL	6"	832.00	10	\$4,811.85	Pcs							
P3361WC	PL	6"	832.00	10	\$5,383.90	Pcs							
P3361X	SS	6"	879.00	10	CALL	Pcs							
P3362NC	PG	7"	971.00	10	\$6,226.50	Pcs							
P3362NC	PL	7"	971.00	10	\$5,614.70	Pcs							
P3362WC	PG	7"	971.00	10	\$6,893.25	Pcs							
P3362WC	PL	7"	971.00	10	\$6,281.95	Pcs							
P3363NC	PG	8"	1110.00	10	\$7,115.95	Pcs							
P3363NC	PL	8"	1110.00	10	\$6,416.35	Pcs							
P3363WC	PG	8"	1110.00	10	\$7,877.80	Pcs							
P3363WC	PL	8"	1110.00	10	\$7,177.15	Pcs							
P3364NC	PG	9"	1249.00	10	\$8,005.55	Pcs							
P3364NC	PL	9"	1249.00	10	\$7,218.50	Pcs							
P3364WC	PG	9"	1249.00	10	\$8,861.15	Pcs							
P3364WC	PL	9"	1249.00	10	\$8,074.70	Pcs							
P3365NC	PG	10"	1387.00	20	\$8,894.65	Pcs							
P3365NC	PL	10"	1387.00	20	\$8,019.95	Pcs							
P3365WC	PG	10"	1387.00	20	\$9,845.90	Pcs							
P3365WC	PL	10"	1387.00	20	\$8,972.15	Pcs							
P3365WC	SS	10"	1480.00	10	CALL	Pcs							
P3366NC	PG	12"	1665.00	10	\$10,673.25	Pcs							
P3366NC	PL	12"	1665.00	10	\$9,624.40	Pcs							
P3366WC	PG	12"	1665.00	10	\$11,814.75	Pcs							
P3366WC	PL	12"	1665.00	10	\$10,766.35	Pcs							
P3366X	PG	12"	1792.00	10	\$9,235.15	Pcs							
P3367NC	PG	14"	1942.00	10	\$12,452.30	Pcs							
P3367NC	PL	14"	1942.00	10	\$11,228.45	Pcs							
P3367WC	PG	14"	1942.00	10	\$13,784.60	Pcs							
P3367WC	PL	14"	1942.00	10	\$12,496.20	Pcs							
P3368NC	PG	16"	2220.00	10	\$14,230.75	Pcs							
P3368NC	PL	16"	2220.00	10	\$12,831.00	Pcs							
P3368WC	PG	16"	2220.00	10	\$15,754.20	Pcs							
P3368WC	PL	16"	2220.00	10	\$14,354.90	Pcs							
P3369NC	PG	18"	2497.00	10	\$16,008.90	Pcs							
P3369X	SS	18"	2614.00	25	CALL	Pcs							
P3370W	SS	20"	2700.00	50	CALL	Pcs							
P3370WC	PG	20"	2775.00	20	\$21,470.05	Pcs							
P3370X	PG	20"	148.00	500	\$751.45	Ft							

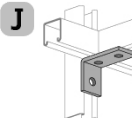
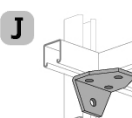

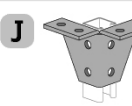



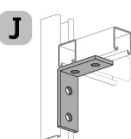
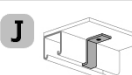
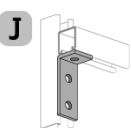
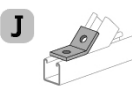
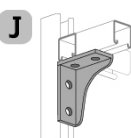
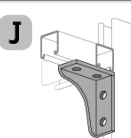
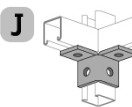
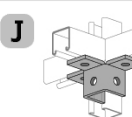



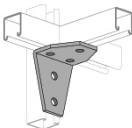



AL-Alum.; CP-Cadmium Plated; EA- Extruded Alum.; EG-Electro-Galv.; EV-Everdur; FG-Fiberglass Reinforced Polyester; GR-Perma-Green; GY-Gray; HG-Hot Dip Galv.; MA-Maple; WH-White; NC-No Closure Strip; W/End Caps and Back Plates; PL-Plain; PG-Pre-Galv.; PO-Porcelain; SS-Stainless 304; ST-Stainless 316; WC-W/Closure Strip, End Caps and Back Plates; X-No Closure Strip or End Caps, W/Back Plates; ZD-Yellow Zinc Dichromate
 Note: For part details and loading information refer to the current Unistrut General Engineering Catalog.

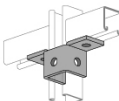













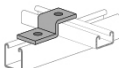

Part No.	Fin.	Size	Wt/100	Std Qty	\$/100	UM	Part No.	Fin.	Size	Wt/100	Std Qty	\$/100	UM
 <p>I 1-1/4" x 1-1/4", 14 Gage</p>													
A1000 10	GR	10 ft. len.	104.00	500	\$558.20	Ft							
A1000 10	PG	10 ft. len.	104.00	500	\$589.15	Ft							
A1000 10	HG	10 ft. len.	110.20	500	\$726.85	Ft							
A1000 10	PL	10 ft. len.	104.00	500	\$489.35	Ft							
A1000 10	EA	10 ft. len.	42.00	500	CALL	Ft							
A1000 10	SS	10 ft. len.	110.00	500	CALL	Ft							
A1000 20	GR	20 ft. len.	104.00	1000	\$558.20	Ft							
A1000 20	PG	20 ft. len.	104.00	1000	\$589.15	Ft							
A1000 20	PL	20 ft. len.	104.00	1000	\$489.35	Ft							
A1000 20	EA	20 ft. len.	42.00	1000	CALL	Ft							
A1000 20	SS	20 ft. len.	110.00	1000	CALL	Ft							
 <p>I 1-1/4" x 2-1/2", 14 Gage , Back-to-Back</p>													
A1001 10	GR	10 ft. len.	208.00	1000	\$1,341.20	Ft							
A1001 10	PG	10 ft. len.	208.00	250	\$1,460.60	Ft							
A1001 10	PL	10 ft. len.	208.00	250	\$1,202.00	Ft							
A1001 20	GR	20 ft. len.	208.00	500	\$1,341.20	Ft							
A1001 20	PG	20 ft. len.	208.00	500	\$1,460.60	Ft							
A1001 20	PL	20 ft. len.	208.00	500	\$1,202.00	Ft							
 <p>I 1-1/4" x 2-1/2", 14 Gage , Side-to-Side</p>													
A1001A 10	GR	10 ft. len.	208.00	10	\$1,341.20	Ft							
A1001A 10	HG	10 ft. len.	220.50	10	\$1,679.60	Ft							
A1001A 10	PL	10 ft. len.	208.00	10	\$1,202.00	Ft							
A1001A 20	PL	20 ft. len.	208.00	20	\$1,202.00	Ft							
 <p>I 1-1/4" x 2-1/2", 14 Gage , Combination</p>													
A1001C 10	PL	10 ft. len.	208.00	10	\$1,220.15	Ft							
A1001C 20	GR	20 ft. len.	208.00	20	\$1,341.20	Ft							
A1001C 20	PL	20 ft. len.	208.00	20	\$1,202.00	Ft							
 <p>J</p>													
A1006-1024	EG	#10-24	6.00	100	\$279.85	Pcs							
A1006-1032	EG	#10-32	7.00	100	\$386.45	Pcs							
A1006-1420	EG	1/4"-20	6.00	100	\$233.65	Pcs							
A1006-1420	AL	1/4"-20	2.00	100	CALL	Pcs							
A1006-1420	SS	1/4"-20	6.00	100	CALL	Pcs							
A1007	EG	5/16"-18	6.00	100	\$233.65	Pcs							
A1007	SS	5/16"-18	6.00	100	CALL	Pcs							
A1008	EG	3/8"-16	6.00	100	\$233.65	Pcs							
A1008	SS	3/8"-16	6.00	100	CALL	Pcs							
 <p>J</p>													
A1026	GR		17.00	50	\$322.35	Pcs							
 <p>J</p>													
A1031	GR		34.00	50	\$996.90	Pcs							
 <p>J</p>													
A1033	GR		34.00	25	\$1,116.40	Pcs							
 <p>J</p>													
A1036	GR		27.00	50	\$732.05	Pcs							
 <p>J</p>													
A1037	GR		30.00	50	\$819.60	Pcs							
 <p>J</p>													
A1038	GR		30.00	50	\$819.60	Pcs							
 <p>J</p>													
A1045	GR		25.00	25	\$392.00	Pcs							
A1045	SS		25.00	50	CALL	Pcs							
 <p>J</p>													
A1047	GR		43.00	25	\$682.85	Pcs							
 <p>J</p>													
A1063	EG		8.00	100	\$146.10	Pcs							
 <p>J</p>													
A1065	GR		17.00	50	\$302.75	Pcs							
A1065	SS		17.00	50	CALL	Pcs							
 <p>J</p>													
A1066	GR		26.00	50	\$354.80	Pcs							
A1066	SS		26.00	50	CALL	Pcs							

AL-Alum.; CP-Cadmium Plated; EA- Extruded Alum.; EG-Electro-Galv.; EV-Everdur; FG-Fiberglass Reinforced Polyester; GR-Perma-Green; GY-Gray; HG-Hot Dip Galv.; MA-Maple; WH-White; NC-No Closure Strip; W/End Caps and Back Plates; PL-Plain; PG-Pre-Galv.; PO-Porcelain; SS-Stainless 304; ST-Stainless 316; WC-W/Closure Strip, End Caps and Back Plates; X-No Closure Strip or End Caps, W/Back Plates; ZD-Yellow Zinc Dichromate
 Note: For part details and loading information refer to the current Unistrut General Engineering Catalog.

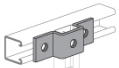

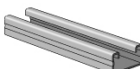

Part No.	Fin.	Size	Wt/100	Std Qty	\$/100	UM	Part No.	Fin.	Size	Wt/100	Std Qty	\$/100	UM
													
A1068	GR		17.00	50	\$296.70	Pcs	A1357	GR		30.00	25	\$930.70	Pcs
	Closure Strip (1-1/4" Series)												
A1184 10	GR	10 ft. len.	21.00	500	\$295.20	Ft	A1458	GR		27.00	50	\$408.65	Pcs
A1184 10	PL	10 ft. len.	21.00	500	\$248.90	Ft							
	PVC Closure Strip (1-1/4" Series)						A1579	GR		44.00	25	\$1,282.95	Pcs
A1184P 10	P	10 ft. len.	21.00	0	CALL	Ft							
							A2084	GR		90.00	20	\$2,333.10	Pcs
A1191	GR		87.00	10	\$887.60	Pcs							
							A2109	GR	52-1/2°	23.00	50	\$398.60	Pcs
A1280	EG		7.00	100	\$391.10	Pcs	A2110	GR	45°	23.00	50	\$398.60	Pcs
							A2111	GR	37-1/2°	23.00	50	\$398.60	Pcs
A1325	GR		38.00	25	\$521.60	Pcs							
							A2120	EG		9.00	50	\$395.35	Pcs
A1326	GR		27.00	50	\$408.65	Pcs							
							A2125	GR	52-1/2°	17.00	50	\$350.45	Pcs
A1331	GR		75.00	25	\$864.05	Pcs	A2126	GR	45°	17.00	50	\$357.45	Pcs
							A2127	GR	37-1/2°	17.00	50	\$350.45	Pcs
A1332	GR		75.00	25	\$864.05	Pcs							
							A2223	GR		34.00	25	\$993.30	Pcs
													
							A2227	GR		52.00	25	\$1,490.85	Pcs

AL-Alum.; CP-Cadmium Plated; EA- Extruded Alum.; EG-Electro-Galv.; EV-Everdur; FG-Fiberglass Reinforced Polyester; GR-Perma-Green; GY-Gray; HG-Hot Dip Galv.; MA-Maple; WH-White; NC-No Closure Strip; W/End Caps and Back Plates; PL-Plain; PG-Pre-Galv.; PO-Porcelain; SS-Stainless 304; ST-Stainless 316; WC-W/Closure Strip, End Caps and Back Plates; X-No Closure Strip or End Caps, W/Back Plates; ZD-Yellow Zinc Dichromate
 Note: For part details and loading information refer to the current Unistrut General Engineering Catalog.



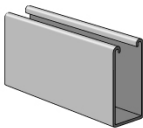

Part No.	Fin.	Size	Wt/100	Std Qty	\$/100	UM
 						
A2235	GR		59.00	25	\$1,940.40	Pcs
 						
A2324	GR		39.00	25	\$642.40	Pcs
 						
A2341L	GR	L	26.00	25	\$852.05	Pcs
A2341R	GR	R	26.00	25	\$852.05	Pcs
 						
A2345	GR		41.00	25	\$1,364.75	Pcs
 						
A2472L	GR	L	33.00	25	\$1,358.30	Pcs
A2472R	GR	R	33.00	25	\$1,358.30	Pcs
 						
A2491L	GR	6	38.00	25	\$1,207.65	Pcs
A2491R	GR	6	38.00	25	\$1,207.65	Pcs
A2492L	GR	8" L	56.00	25	\$1,392.00	Pcs
A2492R	GR	8" R	56.00	25	\$1,392.00	Pcs
A2493L	GR	10" L	73.00	25	\$1,534.30	Pcs
A2493R	GR	10" R	73.00	25	\$1,534.30	Pcs
 						
A2494L	GR	12" L	94.00	25	\$2,204.45	Pcs
A2494R	GR	12" R	94.00	25	\$2,204.45	Pcs
A2495L	GR	14" L	105.00	30	\$2,294.30	Pcs
A2495R	GR	14" R	105.00	30	\$2,294.30	Pcs
A2496L	GR	16" L	145.00	25	\$2,464.55	Pcs
A2496R	GR	16" R	145.00	25	\$2,464.55	Pcs
A2497L	GR	18" L	175.00	20	\$3,141.50	Pcs
A2497R	GR	18" R	175.00	20	\$3,141.50	Pcs
 						
A2608	SS	1/4"	0.60	500	CALL	Pcs
A2611	SS	1/2"	1.00	250	CALL	Pcs
A2612	SS	3/4"	1.40	200	CALL	Pcs
A2613	SS	1"	2.00	200	CALL	Pcs
A2615	SS	1-1/2"	3.20	100	CALL	Pcs

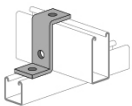
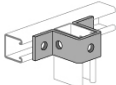
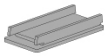



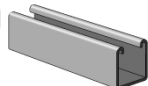
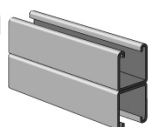
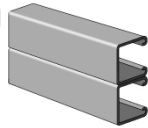
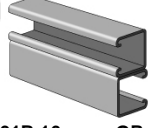
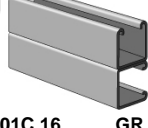









Part No.	Fin.	Size	Wt/100	Std Qty	\$/100	UM
 						
A3006-1420	EG	1/4"-20	6.00	100	\$188.95	Pcs
A3007	EG	5/16"-18	5.00	100	\$190.90	Pcs
A3008	EG	3/8"-16	5.00	100	\$187.45	Pcs
 						
A3016-0832	EG	#8-32	1.00	250	\$86.50	Pcs
A3016-1024	EG	#10-24	1.00	250	\$115.75	Pcs
A3016-1032	EG	#10-32	1.00	250	\$115.75	Pcs
A3016-1420	EG	1/4"-20	1.00	250	\$115.75	Pcs
 						
1-1/4" x 3/4", 14 Gage						
A3300 16	GR	16 ft. len.	78.00	800	\$475.85	Ft
A3300 16	PG	16 ft. len.	78.00	800	\$500.60	Ft
A3300 16	PL	16 ft. len.	78.00	800	\$423.65	Ft
 						
1-1/4" x 1-1/2", 14 Gage						
A3301 16	GR	16 ft. len.	156.00	400	\$1,166.30	Ft
A3301 16	PG	16 ft. len.	156.00	400	\$1,274.45	Ft
A3301 16	PL	16 ft. len.	156.00	400	\$1,034.55	Ft
 						
A3345	GR		23.00	50	\$371.55	Pcs
 						
A3347	GR		37.00	20	\$593.30	Pcs
 						
1-1/4" x 5/8", 19 Gage						
A4000 16	GR	16 ft. len.	45.00	800	\$376.30	Ft
A4000 16	HG	16 ft. len.	47.70	800	\$414.05	Ft
A4000 16	PL	16 ft. len.	45.00	800	\$310.95	Ft
A4000 16	EA	16 ft. len.	25.60	800	CALL	Ft
A4000 20	SS	20 ft. len.	50.00	1000	CALL	Ft
 						
1-1/4" x 1-1/4", 14 Gage Back-to-Back						
A4001 16	GR	16 ft. len.	90.00	400	\$975.05	Ft
A4001 16	HG	16 ft. len.	95.40	400	\$1,052.90	Ft
A4001 16	PL	16 ft. len.	90.00	400	\$845.35	Ft
A4001 16	EA	16 ft. len.	40.00	400	CALL	Ft
 						
A4006-1032	EG	#10-32	6.00	100	\$267.60	Pcs
A4006-1420	EG	1/4"-20	5.00	100	\$222.10	Pcs
A4006-1420	AL	1/4"-20	202.00	100	CALL	Pcs
A4007	EG	5/16"-18	5.00	100	\$225.25	Pcs
A4008	EG	3/8"-16	5.00	100	\$229.50	Pcs
A4008	SS	3/8"-16	5.00	100	CALL	Pcs

AL-Alum.; CP-Cadmium Plated; EA- Extruded Alum.; EG-Electro-Galv.; EV-Everdur; FG-Fiberglass Reinforced Polyester; GR-Perma-Green; GY-Gray; HG-Hot Dip Galv.; MA-Maple; WH-White; NC-No Closure Strip; W/End Caps and Back Plates; PL-Plain; PG-Pre-Galv.; PO-Porcelain; SS-Stainless 304; ST-Stainless 316; WC-W/Closure Strip, End Caps and Back Plates; X-No Closure Strip or End Caps, W/Back Plates; ZD-Yellow Zinc Dichromate
 Note: For part details and loading information refer to the current Unistrut General Engineering Catalog.















Part No.	Fin.	Size	Wt/100	Std Qty	\$/100 UM	Part No.	Fin.	Size	Wt/100	Std Qty	\$/100 UM
J 											
A4120	EG		7.00	100	\$414.75						
J 											
A4280	EG		3.00	100	\$404.50						
I 		1-1/4" x 2-1/2", 14 Gage									
A5000 10	PL	10 ft. len.	167.00	300	\$739.30						Ft
A5000 20	GR	20 ft. len.	167.00	600	\$846.75						Ft
A5000 20	PG	20 ft. len.	167.00	600	\$898.25						Ft
A5000 20	PL	20 ft. len.	167.00	600	\$739.30						Ft
J 											
A5006-1420	EG	1/4"-20	6.00	100	\$274.20						Pcs
A5007	EG	5/16"-18	6.00	100	\$277.55						Pcs
A5008	EG	3/8"-16	6.00	100	\$274.20						Pcs
J 											
A5045	GR		33.00	20	\$567.20						Pcs
J 											
A5047	GR		58.00	25	\$1,117.90						Pcs
J 											
A5280	EG		14.00	100	\$436.15						Pcs















AL-Alum.; CP-Cadmium Plated; EA- Extruded Alum.; EG-Electro-Galv.; EV-Everdur; FG-Fiberglass Reinforced Polyester; GR-Perma-Green; GY-Gray; HG-Hot Dip Galv.; MA-Maple; WH-White; NC-No Closure Strip; W/End Caps and Back Plates; PL-Plain; PG-Pre-Galv.; PO-Porcelain; SS-Stainless 304; ST-Stainless 316; WC-W/Closure Strip, End Caps and Back Plates; X-No Closure Strip or End Caps, W/Back Plates; ZD-Yellow Zinc Dichromate
 Note: For part details and loading information refer to the current Unistrut General Engineering Catalog.

Part No.	Fin.	Size	Wt/100	Std Qty	\$/100	UM
A 		13/16" x 13/16", 19 Gage				
P6000 16	GR	16 ft. len.	37.00	800	\$344.75	Ft
P6000 16	PG	16 ft. len.	37.00	800	\$322.35	Ft
P6000 16	HG	16 ft. len.	39.20	800	\$364.75	Ft
P6000 16	PL	16 ft. len.	37.00	800	\$279.65	Ft
P6000 16	EA	16 ft. len.	14.00	800	CALL	Ft
P6000 16	SS	16 ft. len.	37.00	800	CALL	Ft
A 		13/16" x 1-5/8", 19 Gage Back-to-Back				
P6001 16	GR	16 ft. len.	73.00	400	\$910.85	Ft
P6001 16	PL	16 ft. len.	73.00	400	\$780.45	Ft
P6001 16	EA	16 ft. len.	31.00	400	CALL	Ft
A 		13/16" x 1-5/8", 19 Gage				
P6001A 16	PG	16 ft. len.	73.00	400	\$925.40	Ft
P6001A 16	PL	16 ft. len.	73.00	400	\$780.45	Ft
A 		13/16" x 1-5/8", 19 Gage				
P6001B 16	GR	16 ft. len.	73.00	400	\$910.85	Ft
P6001B 16	PL	16 ft. len.	73.00	400	\$780.45	Ft
A 		13/16" x 1-5/8", 19 Gage				
P6001C 16	GR	16 ft. len.	73.00	400	\$910.85	Ft
P6001C 16	PG	16 ft. len.	73.00	400	\$925.40	Ft
P6001C 16	PL	16 ft. len.	73.00	400	\$780.45	Ft
C 						
P6006-0832	EG	#8-32	1.00	250	\$329.20	Pcs
P6006-1024	EG	#10-24	1.00	500	\$329.20	Pcs
P6006-1032	EG	#10-32	1.00	500	\$329.20	Pcs
P6006-1420	EG	1/4"-20	1.00	500	\$286.45	Pcs
D 						
P6026	EG		5.00	100	\$235.50	Pcs
D 						
P6028	EG		14.00	50	\$1,016.65	Pcs



















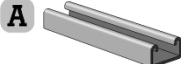

Part No.	Fin.	Size	Wt/100	Std Qty	\$/100	UM
D 						
P6031	EG		11.00	100	\$648.20	Pcs
D 						
P6033	EG		11.00	50	\$748.20	Pcs
D 						
P6036	EG		8.00	100	\$449.75	Pcs
D 						
P6037	EG		8.00	50	\$630.65	Pcs
D 						
P6038	EG		8.00	50	\$633.50	Pcs
D 						
P6045	EG		7.00	100	\$284.00	Pcs
D 						
P6047	EG	13/16"	12.00	50	\$410.70	Pcs
P7047	EG	13/32"	10.00	50	\$387.60	Pcs
D 						
P6048	EG		14.00	50	\$729.85	Pcs
D 						
P6062	EG		2.00	200	\$122.30	Pcs
D 						
P6065	EG		5.00	100	\$201.30	Pcs
D 						
P6066	EG		8.00	100	\$270.75	Pcs
D 						
P6067	EG		11.00	100	\$354.00	Pcs
D 						
P6068	EG		5.00	100	\$251.45	Pcs
D 						
P6069	EG		8.00	100	\$319.35	Pcs

AL-Alum.; CP-Cadmium Plated; EA- Extruded Alum.; EG-Electro-Galv.; EV-Everdur; FG-Fiberglass Reinforced Polyester; GR-Perma-Green; GY-Gray; HG-Hot Dip Galv.; MA-Maple; WH-White; NC-No Closure Strip; W/End Caps and Back Plates; PL-Plain; PG-Pre-Galv.; PO-Porcelain; SS-Stainless 304; ST-Stainless 316; WC-W/Closure Strip, End Caps and Back Plates; X-No Closure Strip or End Caps, W/Back Plates; ZD-Yellow Zinc Dichromate
 Note: For part details and loading information refer to the current Unistrut General Engineering Catalog.

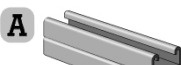





Part No.	Fin.	Size	Wt/100	Std Qty	\$/100	UM
 P6127	EG	6-1/2"	30.00	25	\$2,986.85	Pcs
P6128	EG	8-1/2"	40.00	25	\$3,285.05	Pcs
P6129	EG	10-1/2"	50.00	50	\$3,425.25	Pcs
 P6130	EG		32.00	25	\$1,177.40	Pcs
 P6184P 10	GR	Closure Strip (13/16" Series) 10 ft. len.	5.00	500	\$289.00	Ft
 P6186	EG	45°	8.00	50	\$321.55	Pcs
P7108	EG	60°	8.00	100	\$261.85	Pcs
 P6280	EG		3.00	100	\$412.10	Pcs
 P6281	EG	2"	8.00	100	\$456.25	Pcs
P6282	EG	2-1/2"	9.00	50	\$482.80	Pcs
P6283	EG	3"	10.00	50	\$504.05	Pcs
 P6325	EG		11.00	100	\$401.35	Pcs
 P6326	EG		8.00	50	\$319.35	Pcs
 P6331	EG		19.00	50	\$658.60	Pcs
 P6332	EG		19.00	50	\$658.60	Pcs
 P6334	EG		11.00	50	\$539.15	Pcs
 P6346	EG		8.00	100	\$321.55	Pcs
 P6347	EG		7.00	100	\$376.75	Pcs
 P6349	EG		1.00	100	\$317.40	Pcs

Part No.	Fin.	Size	Wt/100	Std Qty	\$/100	UM
 P6353	EG		1.00	100	\$352.40	Pcs
 P6356A	EG		10.00	50	\$707.45	Pcs
 P6357	EG		10.00	50	\$809.90	Pcs
 P6358A	EG		15.00	50	\$807.60	Pcs
 P6359	EG		15.00	50	\$928.25	Pcs
 P6376	EG		17.00	25	\$553.00	Pcs
 P6376A	EG		26.00	25	\$656.40	Pcs
 P6377	EG		36.00	25	\$816.25	Pcs
 P6379S	EG		13.00	50	\$1,714.85	Pcs
 P6380	EG		15.00	50	\$547.70	Pcs
 P6380A	EG		11.00	50	\$520.35	Pcs
 P6381	EG		15.00	25	\$656.85	Pcs
 P6382	EG		15.00	25	\$656.85	Pcs
 P6386	EG		4.00	100	\$458.05	Pcs







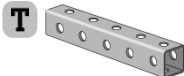

AL-Alum.; CP-Cadmium Plated; EA- Extruded Alum.; EG-Electro-Galv.; EV-Everdur; FG-Fiberglass Reinforced Polyester; GR-Perma-Green; GY-Gray; HG-Hot Dip Galv.; MA-Maple; WH-White; NC-No Closure Strip; W/End Caps and Back Plates; PL-Plain; PG-Pre-Galv.; PO-Porcelain; SS-Stainless 304; ST-Stainless 316; WC-W/Closure Strip, End Caps and Back Plates; X-No Closure Strip or End Caps, W/Back Plates; ZD-Yellow Zinc Dichromate
 Note: For part details and loading information refer to the current Unistrut General Engineering Catalog.

Part No.	Fin.	Size	Wt/100	Std Qty	\$/100 UM	Part No.	Fin.	Size	Wt/100	Std Qty	\$/100 UM	
 P6453	EG		9.00	50	\$607.75 Pcs	 P6918	EG		21.00	25	\$794.40 Pcs	
 P6454	EG		5.00	100	\$240.35 Pcs	 P6924	EG		5.00	100	\$335.05 Pcs	
 P6458	EG		8.00	50	\$319.35 Pcs	 P6925	EG		7.00	50	\$486.70 Pcs	
 P6546	EG	45°	8.00	100	\$321.55 Pcs	 P6962	EG		19.00	50	\$477.25 Pcs	
P7097	EG	60°	8.00	100	\$261.85 Pcs	 P6973	EG		8.00	50	\$683.90 Pcs	
P7100	EG	37-1/2°	8.00	100	\$261.85 Pcs	 P7000 10	GR	13/16" x 13/32", 19 Gage	10 ft. len.	26.00	1000	\$333.45 Ft
P7101	EG	30°	8.00	100	\$261.85 Pcs	P7000 10	PG		10 ft. len.	26.00	1000	\$273.60 Ft
 P6579	EG		15.00	50	\$1,267.95 Pcs	P7000 10	HG		10 ft. len.	27.60	1000	\$328.60 Ft
 P6726A	EG		22.00	50	\$743.25 Pcs	P7000 10	PL		10 ft. len.	26.00	1000	\$268.55 Ft
 P6728	EG		22.00	50	\$846.15 Pcs	P7000 10	EA		10 ft. len.	10.00	1000	CALL Ft
 P6737	EG		16.00	25	\$923.90 Pcs	P7000 10	SS		10 ft. len.	26.00	1000	CALL Ft
 P6758	EG		13.00	50	\$872.25 Pcs	 P7001 10	GR	13/16" x 13/16", 19 Gage Back-to-Back	10 ft. len.	52.00	250	\$886.90 Ft
 P6805	EG	1/4" - 1/4"	1.00	100	\$248.35 Pcs	P7001 10	PG		10 ft. len.	52.00	250	\$898.80 Ft
P6805	SS	1/4" - 1/4"	1.00	200	CALL Pcs	P7001 10	PL		10 ft. len.	52.00	250	\$756.75 Ft
P6806	EG	3/8" - 3/8"	2.00	100	\$260.90 Pcs	P7001 10	EA		10 ft. len.	15.00	500	CALL Ft
P6806	SS	3/8" - 3/8"	2.00	100	CALL Pcs	 P7006-0832	EG	#8-32	1.00	500	\$329.20 Pcs	
P6807	EG	1/2" - 1/2"	3.00	100	\$263.35 Pcs	P7006-1024	EG	#10-24	1.00	500	\$329.20 Pcs	
P6807	SS	1/2" - 1/2"	3.00	100	CALL Pcs	P7006-1032	EG	#10-32	1.00	500	\$329.20 Pcs	
P6808	EG	1/4" - 3/8"	2.00	100	\$260.20 Pcs	P7006-1420	EG	1/4"-20	1.00	500	\$286.45 Pcs	
P6808	SS	1/4" - 3/8"	2.00	100	CALL Pcs	 P7008	EG	1/4"	1.00	200	\$221.55 Pcs	
P6809	EG	1/4" - 1/2"	2.00	100	\$261.70 Pcs	P7008	SS	1/4"	2.00	100	CALL Pcs	
P6809	SS	1/4" - 1/2"	2.00	100	CALL Pcs	P7009	EG	5/16"	1.00	200	\$225.70 Pcs	
P6810	EG	3/8" - 1/2"	3.00	100	\$262.05 Pcs	P7010	EG	3/8"	2.00	200	\$227.75 Pcs	
 P6887	EG		28.00	25	\$1,371.10 Pcs	P7010	SS	3/8"	2.00	200	CALL Pcs	
 P6917	EG		21.00	25	\$794.40 Pcs	P7012	EG	1/2"	2.00	100	\$237.95 Pcs	
						P7012	SS	1/2"	2.00	100	CALL Pcs	
						P7014	EG	5/8"	3.00	100	\$212.40 Pcs	
						P7016	EG	3/4"	4.00	100	\$219.00 Pcs	
						P7016	SS	3/4"	4.00	100	CALL Pcs	
						P7018	EG	7/8"	5.00	100	\$228.25 Pcs	
						P7020	EG	1"	5.00	100	\$230.40 Pcs	
						P7020	SS	1"	5.00	100	CALL Pcs	
						 P7045	EG		6.00	100	\$258.85 Pcs	

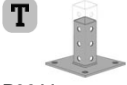



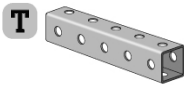

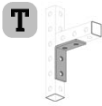

AL-Alum.; CP-Cadmium Plated; EA- Extruded Alum.; EG-Electro-Galv.; EV-Everdur; FG-Fiberglass Reinforced Polyester; GR-Perma-Green; GY-Gray; HG-Hot Dip Galv.; MA-Maple; WH-White; NC-No Closure Strip; W/End Caps and Back Plates; PL-Plain; PG-Pre-Galv.; PO-Porcelain; SS-Stainless 304; ST-Stainless 316; WC-W/Closure Strip, End Caps and Back Plates; X-No Closure Strip or End Caps, W/Back Plates; ZD-Yellow Zinc Dichromate
 Note: For part details and loading information refer to the current Unistrut General Engineering Catalog.

Part No.	Fin.	Size	Wt/100	Std Qty	\$/100 UM	Part No.	Fin.	Size	Wt/100	Std Qty	\$/100 UM
 P7048	EG		10.00	50	\$713.65						
 P7235	EG		18.00	50	\$1,156.95						
 P7280	EG		1.00	100	\$119.90						
 P7324	EG		10.00	100	\$607.75						
 P7347	EG		6.00	50	\$265.05						
 P7376	EG		11.00	50	\$477.35						
 P7377	EG		24.00	25	\$621.95						

AL-Alum.; CP-Cadmium Plated; EA- Extruded Alum.; EG-Electro-Galv.; EV-Everdur; FG-Fiberglass Reinforced Polyester; GR-Perma-Green; GY-Gray; HG-Hot Dip Galv.; MA-Maple; WH-White; NC-No Closure Strip; W/End Caps and Back Plates; PL-Plain; PG-Pre-Galv.; PO-Porcelain; SS-Stainless 304; ST-Stainless 316; WC-W/Closure Strip, End Caps and Back Plates; X-No Closure Strip or End Caps, W/Back Plates; ZD-Yellow Zinc Dichromate
 Note: For part details and loading information refer to the current Unistrut General Engineering Catalog.

Part No.	Fin.	Size	Wt/100	Std Qty	\$/100	UM	Part No.	Fin.	Size	Wt/100	Std Qty	\$/100	UM
													
1-5/8" x 1-5/8" Telestrut Tubing													
P9000 10	GR	10 ft. len.	205.00	250	\$873.40	Ft							
P9000 10	PG	10 ft. len.	205.00	250	\$1,018.15	Ft							
P9000 20	GR	20 ft. len.	205.00	500	\$873.40	Ft							
P9000 20	PG	20 ft. len.	205.00	500	\$1,018.15	Ft							
P9000 20	PL	20 ft. len.	205.00	500	\$856.20	Ft							
													
P9010	EG		10.00	100	\$361.65	Pcs							
													
P9011	GR		332.30	10	\$4,640.65	Pcs							
													
P9012	GR		340.40	10	\$4,730.05	Pcs							
													
P9013	GR		318.40	10	\$4,246.70	Pcs							
													
P9014	GR		303.20	10	\$4,624.05	Pcs							
													
1 7/8" x 1 7/8" Telestrut Tubing													
P9200 10	GR	10 ft. len.	223.00	250	\$1,006.45	Ft							
P9200 10	PG	10 ft. len.	223.00	250	\$1,163.45	Ft							
P9200 20	GR	20 ft. len.	223.00	500	\$1,006.45	Ft							
P9200 20	PG	20 ft. len.	223.00	500	\$1,163.45	Ft							
P9200 20	PL	20 ft. len.	223.00	500	\$970.30	Ft							
													
P9207	EG		67.00	20	\$4,820.15	Pcs							
													
P9209	EG		46.00	25	\$2,152.90	Pcs							
													
P9324	GR		78.00	25	\$1,000.00	Pcs							
P9324	EG		78.00	25	\$1,000.00	Pcs							

AL-Alum.; CP-Cadmium Plated; EA- Extruded Alum.; EG-Electro-Galv.; EV-Everdur; FG-Fiberglass Reinforced Polyester; GR-Perma-Green; GY-Gray; HG-Hot Dip Galv.; MA-Maple; WH-White; NC-No Closure Strip; W/End Caps and Back Plates; PL-Plain; PG-Pre-Galv.; PO-Porcelain; SS-Stainless 304; ST-Stainless 316; WC-W/Closure Strip, End Caps and Back Plates; X-No Closure Strip or End Caps, W/Back Plates; ZD-Yellow Zinc Dichromate
 Note: For part details and loading information refer to the current Unistrut General Engineering Catalog.

Part No.	Fin.	Size	Wt/100	Std Qty	\$/100	UM	Part No.	Fin.	Size	Wt/100	Std Qty	\$/100	UM
 H Light Duty Prime Angle, 1-5/8" X 1-5/8" , 14 Gage													
PA158 10	GR	10 ft. len.	66.00	100	\$265.40	Ft							
PA158 10	PG	10 ft. len.	66.00	100	\$265.40	Ft							
PA158 12	GR	12 ft. len.	66.00	120	\$265.40	Ft							
PA158 12	PG	12 ft. len.	66.00	120	\$265.40	Ft							
 H													
PA1GP	PG		9.00	25	\$142.65	Pcs							
 H													
PA1HDC			1700.00	1	\$133,103.70	Pcs							
 H													
PA1RC			100.00	2	\$3,802.05	Pcs							
 H Slotted Strap (Prime Angle)													
PA1RP	PG		35.00	100	\$517.00	Ft							
 H													
PA1SC			170.00	2	\$4,754.65	Pcs							
 H													
PA1SNB	EG		450.00	1	\$55.30								
 H Medium Duty Prime Angle, 1-5/8" x 2-3/8", 14 Gage													
PA238 10	GR	10 ft. len.	80.00	100	\$291.20	Ft							
PA238 10	PG	10 ft. len.	80.00	100	\$291.20	Ft							
PA238 12	GR	12 ft. len.	80.00	120	\$291.20	Ft							
PA238 12	PG	12 ft. len.	80.00	120	\$291.20	Ft							
 H Heavy Duty Prime Angle, 1-5/8" x 3-1/8", 12 Gage													
PA318 10	GR	10 ft. len.	130.00	100	\$414.75	Ft							
PA318 10	PG	10 ft. len.	130.00	100	\$414.75	Ft							
PA318 12	GR	12 ft. len.	130.00	120	\$414.75	Ft							
PA318 12	PG	12 ft. len.	130.00	120	\$414.75	Ft							

AL-Alum.; CP-Cadmium Plated; EA- Extruded Alum.; EG-Electro-Galv.; EV-Everdur; FG-Fiberglass Reinforced Polyester; GR-Perma-Green; GY-Gray; HG-Hot Dip Galv.; MA-Maple; WH-White; NC-No Closure Strip; W/End Caps and Back Plates; PL-Plain; PG-Pre-Galv.; PO-Porcelain; SS-Stainless 304; ST-Stainless 316; WC-W/Closure Strip, End Caps and Back Plates; X-No Closure Strip or End Caps, W/Back Plates; ZD-Yellow Zinc Dichromate
 Note: For part details and loading information refer to the current Unistrut General Engineering Catalog.

are the basis of all such offers. Such solicited offers are subject to acceptance or rejection by Unistrut as set forth below. Written quotations automatically expire sixty (60) calendar days from the date issued unless otherwise stated thereon or unless sooner terminated by notice. Prices stated in a written quotation are subjected to the pricing terms specified below. All clerical errors are subject to correction.

Orders for Products shall not be binding on Unistrut, if in excess of \$10,000, until signed by the President or a Vice President or accepted by acknowledgment or shipment. Any such orders or contract shall be subject to these standard conditions of sale and acceptance shall be contingent on assent to these conditions, which assent shall be deemed given unless purchaser shall expressly notify Unistrut to the contrary within five (5) days after receipt of acknowledgment or signed contract and Unistrut shall expressly agree thereto in writing. Failure of Unistrut to object to provisions contained in any purchase order or installation contract or other communication from the purchaser (including, without limitation, penalty clauses of any kind) shall not be construed as a waiver of these conditions nor any acceptance of any such provisions. In the event of conflict (a) between the terms of any order or contract of purchaser and Unistrut's conditions of sale, the latter shall govern, and (b) in the event of a conflict between Unistrut Quotation or Service Center Agreement and these terms and conditions, the former shall govern.

Unistrut reserves the right to ship only in minimum quantities and standard packaging and to increase ordered quantities to such minimums. No order or contract may be cancelled or terminated except upon payment of any loss, damage and expense incurred by Unistrut arising from such cancellation or termination, including a fifteen (15) percent restocking charge, plus freight if Unistrut in its sole discretion, elects to accept any cancellation.

- 2. DELIVERY:** On Material Supply sales, delivery to a carrier at the Unistrut Plant or other shipping point shall constitute delivery to purchaser; and, regardless of freight payment, title and all risk of loss or damage in transit shall pass to the purchaser upon delivery to the carrier.

All claims for loss and damage in transit must be made by purchaser to the carrier. Claims for shortage or other errors must be made in writing to Unistrut within ten (10) days after receipt of shipment, and failure to give such notice shall constitute unqualified acceptance and a waiver of all such claims by purchaser against Unistrut.

Unistrut reserves the right to determine shipment methods and routings if not specified by Purchaser. All transportation charges will be added to the invoice.

Unistrut shall not be liable for any damage as a result of any delay due to any cause beyond its reasonable control including, without limitation, an act of God; an act of Purchaser; embargo or other governmental act; regulation or request; fire; accident; strike; slowdown; wars; riots; delay in transportation. When required, Unistrut will supply shop drawings in a timely manner to meet construction and contract schedules. Unistrut cannot, however, be responsible for delays in approvals.

IN EVENT OF DELAY BY UNISTRUT FOR ANY CAUSE BEYOND ITS REASONABLE CONTROL, INCLUDING DRAWINGS APPROVAL DELAY ON THE PART OF THE CONTRACTOR, OWNER OR ARCHITECT, THE OWNER OR THE OWNER'S REPRESENTATIVE, THE DATE OF DELIVERY SHALL BE EXTENDED, AS WILL THE COMPLETION DATE OF THE WORK, FOR A PERIOD EQUAL TO THE TIME LOST BY REASON OF THE DELAY.

Except as expressly otherwise provided herein where installation or construction services are to be provided by Unistrut, the latest

effective AIA General Conditions for a contract for construction will be deemed incorporated herein.

- 3. PRICES AND PAYMENT:** Unless otherwise stated, prices are F.O.B. shipping point.

Unistrut reserves the right at any time to demand full or partial payment before proceeding with any order on any order already shipped or contract of sale if, in its judgment, the financial condition of Purchaser does not justify the terms of payment specified. If delivery is delayed or deferred by Purchaser beyond Unistrut's scheduled shipment date, payment shall be due in full when Unistrut is prepared to ship, and the product so delayed or deferred by purchaser may be stored by Unistrut at the risk and expense of the purchaser. If purchaser defaults when payment is due, then the whole contract price shall become due and payable on demand, or Unistrut, at its option, without prejudice to other lawful remedies, may defer delivery or cancel the contract. In addition to other remedies, Unistrut shall be entitled to recover costs and expenses incurred by Unistrut in connection with any breach by Purchaser, including any reasonable collection costs and attorney's fees. When contract performance will run more than one calendar month, PROGRESS PAYMENTS will be required and FINAL PAYMENT (including any monies retained during the performance of the contract) will be made promptly after inspection and acceptance of the Unistrut portion of the work under the contract. Any amount not timely paid by Purchaser shall bear interest at the maximum rate permitted by law, not to exceed 1 1/2% per month.

- 4. TAXES AND OTHER CHARGES:** All taxes, Federal, State, Provincial, Municipal, Local or otherwise, shall be paid by purchaser. In the event: Unistrut shall be required to pay any such tax, fee or charge, purchaser shall reimburse Unistrut therefore; or in lieu of such payment; purchaser shall provide Unistrut at the time the order is submitted an exemption certificate or other document acceptable to the authority imposing the tax, fee or charge. Purchase orders must state the existence and amount of any such tax, fee or charge which it shall be Unistrut's responsibility to collect from purchaser and pay.

- 5. WARRANTY:** Unistrut warrants for a period of one (1) year from the date of shipment for material sales and one (1) year from the date of completion of installed work that any product sold to Purchaser hereunder will be free from defects in material or workmanship at the time of delivery to the carrier. Unistrut's sole responsibility in the event of any such defect in material or workmanship in violation of the warranty shall be at Unistrut's option to repair or replace any such defective product.

THE AFORESAID WARRANTY IS IN LIEU OF ALL OTHER WARRANTIES, EXPRESS OR IMPLIED, AND UNISTRUT EXPRESSLY

DISCLAIMS ANY OTHER WARRANTY INCLUDING MERCHANTABILITY OR FITNESS FOR A PARTICULAR PURPOSE. NO AGENT, EMPLOYEE OR REPRESENTATIVE OF UNISTRUT IS AUTHORIZED TO ALTER THESE TERMS AND CONDITIONS NOR TO VARY OR SUPPLEMENT THEM IN ANY WAY.

- 6. REMEDIES OF PURCHASER ARE EXCLUSIVE:** The remedies of the purchaser set forth herein are exclusive and the liability of Unistrut with respect to any contract or anything done in connection therewith such as the performance, nonperformance or breach thereof, or from the manufacture, sale, delivery, resale or use of any product covered by or furnished under the contract, whether in contract, in tort (including negligence and strict liability) or otherwise, shall not exceed the price of the equipment, services or part thereof on which such liability is based.

- 7. LIMITATION OF LIABILITY:** UNISTRUT WILL NOT BE LIABLE FOR

ANY DIRECT, INDIRECT, CONSEQUENTIAL, SPECIAL, CONTINGENT OR INCIDENTAL DAMAGES WHATSOEVER, INCLUDING WITHOUT LIMITATION, PENALTIES SUFFERED BY PURCHASER AS THE RESULT OF ANY BREACH OF CONTRACT, BREACH OF WARRANTY OR TORTIOUS ACT COMMITTED IN CONNECTION WITH ITS SUPPLYING, OR FAILURE TO SUPPLY, EQUIPMENT PURSUANT TO ANY ORDER OR OTHER CONTRACT OR FOR ANY LABOR COSTS INCURRED AS A RESULT THEREOF OTHER THAN AS LISTED IN PARAGRAPH 5 AND 6 ABOVE. IN ARRIVING AT THE PRICES QUOTED TO OR CHARGED TO PURCHASER, UNISTRUT HAS RELIED UPON THE APPLICABILITY OF THE TERMS, AND CONDITIONS HEREIN, INCLUDING THE LIMITATIONS SET FORTH IN THIS PARAGRAPH AND PARAGRAPHS 5 AND 6 ABOVE.

8. CHANGES, SHOP DRAWINGS, FABRICATION: Any changes as to: (i) specifications, (ii) drawings, and/or (iii) quantities ordered by purchaser are subject to acceptance by Unistrut. If any change causes an increase or decrease in the cost or the time required for performance, an equitable adjustment shall be made in the contract price or delivery schedule, or both. Pending agreement between the parties to any equitable adjustment, Unistrut shall not be obligated to proceed with an accepted change and the date of delivery shall be extended accordingly.

Preparation of shop drawings will commence upon receipt by Unistrut of contract or purchase order and a complete set of project bid documents.

Unistrut will not be obligated to commence fabrication, until the receipt of a copy of the approved shop drawings, finish selection, and shipping instructions, unless directed by an acceptable waiver of approval form.

9. PURCHASER'S COMPLIANCE WITH LAWS: Unistrut does not assume any liability for the purchaser's compliance with or adherence to any federal, state or local laws or regulations.

10. GOVERNING LAW: All contracts for the sale of Products shall be governed and construed according to the laws of the State of Michigan except where installed, and then the state in which the materials are to be installed by Unistrut Corporation.

Any disputes arising out of or in connection with the sale of Products shall be submitted to Arbitration under the Commercial Arbitration rules of the American Arbitration Association if the dispute arises in the United States, or under International Chamber of Commerce rules or the United Nations Treaty on Commercial Arbitration, at Unistrut's option, if it does not. Purchaser agrees to submit to such arbitration to be bound by it and agrees that any award may be entered as a judgment and enforced as such. Purchaser agrees that arbitration hereunder will take place (1) at the city from which this purchase order was placed, (2) Wayne, Michigan U.S.A., (3) London, England, (4) Sydney, Australia, or (5) the place at which Products were supposed to be utilized. Regardless of the place of arbitration, all proceedings, writings, and evidence shall be in the English language. The Purchaser agrees to allow Unistrut the option of choosing the place of arbitration so long as the site is proximate to Unistrut's witnesses, documents and is the location from which Unistrut managed or would have managed the sale of Products described herein or in Purchaser's order.

Arbitration issues shall include all questions as to whether the right to arbitrate any questions exists. Arbitration may proceed in the absence of any party if written notice (pursuant to the applicable rules and regulations) of the proceedings has been given to such party.

Unless the applicable Arbitration rules permit more or broader pre-hearing discovery, the parties to any dispute hereunder shall have the right to engage in limited pre-hearing discovery as follows: each

party to the dispute shall be entitled to one (1) request for document production and shall be entitled to take the deposition, under oath, of one witness from each other party. The discovery shall proceed pursuant to the provisions of the United States Code of Civil Procedure governing discovery in civil litigation and all conditions and objections allowed under the said rules shall be allowed with respect to such discovery. The arbitrators shall rule upon motions to compel or limit discovery and shall have the authority to impose sanctions, including attorney's fees and costs, to the same extent as a court of law or equity should the arbitrators determine that discovery was sought without substantial justification or that discovery was refused or objected to without substantial justification.

Notwithstanding any provisions in the Contract Documents, neither party shall have any right to compel the other to arbitrate any dispute involving a claim for money or any other dispute, unless all parties necessary to the complete determination of all rights and liabilities, including claims over against third parties, may be compelled or agrees to join in and be bound by the arbitration proceedings.

11. NOTICE OF LIEN: Unistrut hereby notifies the Purchaser that it intends to utilize all available lien rights it may have in connection with the sale of Products hereunder.

12. SALE CONVEYS NO LICENSE: The sale of Products hereunder creates no right or license in the Purchaser to use the name, Trademarks, Copyrights, Patents, know how or any other right of Unistrut other than the Products provided hereunder.

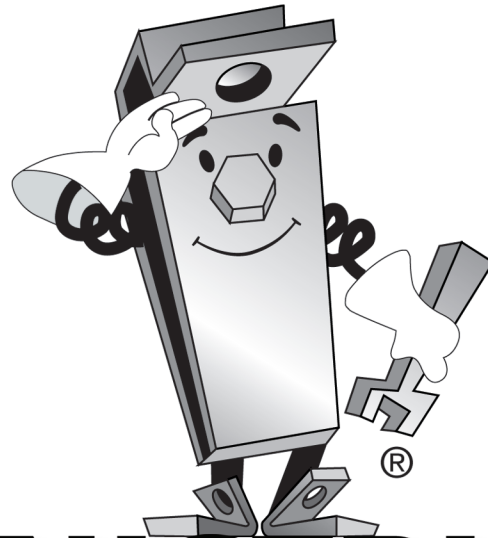

UNISTRUT®

4205 Elizabeth St. • Wayne, MI 48184

Telephone: 800-521-7730

www.unistrut.com